

Issue:
30.10.2015
51223100

RF remote control, 2-gang

RF remote control, 4-gang

Order No. 5122 00

Order No. 5124 00



Table of Contents

1	Product definition	3
1.1	Product catalogue	3
1.2	Function	3
1.3	Accessories	4
2	Installation, electrical connection and operation	5
2.1	Safety instructions	5
2.2	Device components	6
2.3	Commissioning	7
2.4	Operation	9
3	Technical data	10
4	Software description	11
4.1	Software specification	11
4.2	Software "KNX RF Hand-held transmitter"	12
4.2.1	Scope of functions	12
4.2.2	Notes on software	13
4.2.3	Object table	14
4.2.4	Functional description	16
4.2.4.1	Display functions	16
4.2.4.2	Rockers and button functions	23
4.2.4.2.1	Switching function	23
4.2.4.2.2	Dimming function	26
4.2.4.2.3	"Blind" function	28
4.2.4.2.4	Function "Value transmitter 1 byte"	30
4.2.4.2.5	Scene extension function	32
4.2.4.3	Delivery state	35
4.2.5	Parameters	36
5	Appendix	43
5.1	Application basics	43
5.1.1	The KNX RF system	43
5.1.2	Basic physical principles	47
5.1.3	Building structure and RF topology	54
6	Index	68

1 Product definition

1.1 Product catalogue

Product name: RF remote control, 2-gang / RF remote control, 4-gang

Use: Sensor

Design: Mobile

Order No. 5122 00 / 5124 00

1.2 Function

If the application program is loaded and, depending on the parameter settings, the KNX RF hand-held transmitter sends wireless KNX telegrams when its buttons are pressed. These can be, for instance, telegrams for switching or push button control, for dimming or for controlling blinds. It is also possible to program value transmitter functions (dimming value transmitters and light scene extensions).

The KNX RF hand-held transmitter has 4 or 8 buttons depending on the device variant. Two adjacent buttons each form as a pair one rocker switch. The function of a rocker switch can be configured individually in the ETS. Each rocker switch has its own KNX communication objects and can therefore actuate KNX actuator groups separately.

The device has a two-coloured LED for indicating actuation and status. This makes it possible to indicate successful operation and sending processes. The bidirectional communication also makes it possible to temporarily indicate states of the KNX actuator immediately after an operation by means of the LED. For this purpose, the device has separate status communication objects.

The activation or status evaluation of cabled KNX systems (Medium TP) can be implemented using an media coupler, which is available as an accessory. Additionally or alternatively, suitable KNX RF actuators can be activated and evaluated directly by the KNX RF hand-held transmitter.

After the last operation, the KNX RF hand-held transmitter automatically switches to energy-saving mode after a specified time has elapsed. In energy-saving mode, the LED remains switched off. During operation, the energy saving mode is exited. The device then executes the programmed button commands.

The device is commissioned using the ETS of Version 5 or higher. Programming mode is activated by a separate programming button, located in the battery compartment. An active programming mode is displayed by the LEDs.

The radio range of the KNX RF hand-held transmitter depends on various external circumstances. The range can be optimised by selecting a suitable operating location (communication to the receiver with as few obstacles as possible).

The device meets the requirements of the R&TTE directive 1999/5/EC and may be operated in all EU and EFTA countries.

1.3 Accessories

RF/TP media coupler/repeater
KNX RF USB data interface (USB stick)

Order No. 5110 00
Order No. 5120 00

2 Installation, electrical connection and operation

2.1 Safety instructions

Electrical equipment may only be installed and fitted by electrically skilled persons. The applicable accident prevention regulations must be observed.

Failure to observe the instructions may cause damage to the device and result in fire and other hazards.

Keep button cells out of reach of children! If button cells are swallowed, get medical help immediately.

Risk of explosion! Do not throw batteries into fire.

Risk of explosion! Do not recharge batteries.

The radio communication takes place via a non-exclusively available transmission path, and is therefore not suitable for safety-related applications, such as emergency stop and emergency call.

2.2 Device components

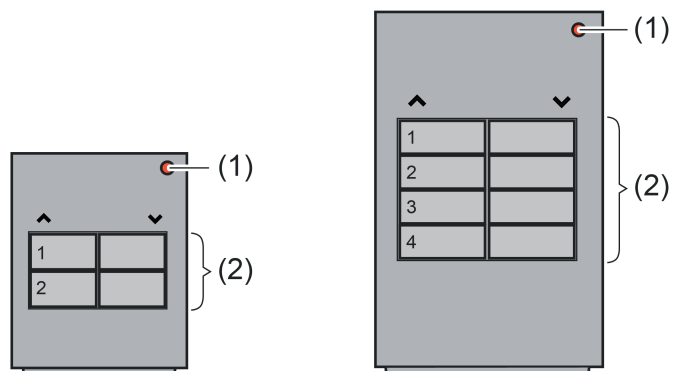

Figure 1: Device components Hand-held transmitter, 2x (left) and 4x (right)

- (1) Send and status LED (green / red)
- (2) Operating rocker switches (one button pair per rocker switch)

2.3 Commissioning

Insert battery



WARNING!

Risk of chemical burns.

Batteries can burst and leak.

Replace batteries only with an identical or equivalent type.

- Open battery compartment on the rear side of the hand-held transmitter.
 - ❗ Keep contacts of batteries and device free of grease.
 - Apply battery to the positive contact of the battery holder. Observe polarity: the positive pole of the battery must be at the top.
 - Press gently on battery to snap it in.
 - Close battery compartment.
- The hand-held transmitter is ready for operation.

Programming the addresses and application program

Project design and commissioning with ETS5 or a more recent version.

An appropriate device must be created and configured in the ETS project.

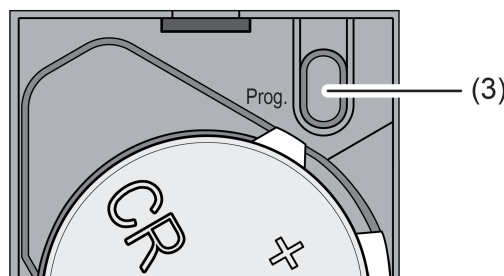

Figure 2: Programming button in battery compartment

- Press the programming button (3).
The LED (1) lights up red. Programming mode is activated.
- Load the physical address into the device. The ETS also automatically loads the domain address of the RF line into the device.
The LED goes out.
- ❗ Programming mode without access by the ETS is automatically terminated after 1 minute.
- ❗ For the programming of the physical address and the domain address to be carried out and completed correctly, the domain address of the RF line must match the domain address of the RF communication interface (e.g. KNX RF USB data interface or media coupler).
Otherwise, communication errors can be expected.
The domain address of the KNX RF USB data interface used by the ETS is configured in the general connection settings of the ETS. In an ETS project, the domain address of an RF line or a media coupler is configured in the line properties (separate for each RF line).
- Write the physical address and domain address on the inner side of the battery compartment lid of the hand-held transmitter.
- Load the application program into the device using the ETS.

- i** After the last operation or general programming of the physical address, the device automatically switches to energy-saving mode after a short time. In energy-saving mode, the LED remains switched off. If the device is in energy-saving mode, this mode must be actively terminated, before the application program can be programmed by the ETS. This can be done by pressing a button or the programming button. Alternatively, the application program can be programmed into the device together with the addresses.
- i** For devices which have been used for a longer period: Before ETS programming operations, replace the battery with a new, unused one.
- i** If the device does not contain an application program, or the wrong application program (e.g. unloaded application program), then the LED flashes slowly in red and green for 3 seconds after a button-press.

2.4 Operation

Operating and display functions

The KNX RF hand-held transmitter has 4 or 8 buttons, depending on the device variant. As a pair, two adjacent buttons each form one operating rocker switch. The function of a rocker switch can be configured individually in the ETS. Each rocker switch has its own KNX communication objects and can therefore actuate KNX actuator groups separately. The function of a rocker switch can be configured individually to "Switching", "Dimming", "Venetian Blind", "Value transmitter 1-byte" and "Scene extension" and can thus be adjusted flexibly to the operating requirements.

For more detailed information on the operating functions, please refer to the chapter "Software Description" of this documentation (see page 23).

The device has a two-coloured LED for indicating actuation and status. This makes it possible to indicate successful operation and sending processes. The bidirectional communication also makes it possible to temporarily indicate states of the KNX actuator immediately after an operation by means of the LED. For this purpose, the device has separate status communication objects.

For more detailed information on the function of the LED display, please also refer to the chapter "Software Description" of this documentation (see page 16).

Invalid operation

If a button is pressed for a time longer than defined by the ETS parameter "Time window for operation..." (available separately for each button), then the device will evaluate this operation as invalid to prevent wear on the battery. The operation is ended correctly (e.g. by sending a Stop telegram during a dimming operation). The device then returns to energy-saving mode immediately. Only a new button-press wakes up the device again.

The device also evaluates the simultaneous pressing of multiple buttons as a wrong operation. If only one button is pressed, the device will execute the configured operating command. If, when the button is held down, a further button is pressed, then the device will not execute any new operating commands. It is first necessary to release all buttons before new commands can be triggered. The same applies if no button is pressed and, in this state, it is as if multiple buttons have been pressed simultaneously. An operating command is only sent as soon as only one button is clearly detected as having been pressed.

- i** If two (or more) buttons are pressed consecutively, then the device only ends the button command executed by the first button-press, assuming that other telegrams are to be executed (e.g. Venetian blind function), immediately when another button is detected as having been pressed.

Battery display

When a button is pressed, the device checks the battery. If a weak or discharged battery is detected, then, after a button-press, the red LED will flash for a period of approx. 3 seconds at a frequency of approx. 0.75 Hz. In the case of such a display, replace the battery with a new one as soon as possible (see page 7).

- i** The battery display is activated as an alternative to the button-press display after a button-press. Battery display also occurs when the function of the red send and actuation LED is configured as "Always OFF".

3 Technical data

General

Mark of approval	KNX
Rated voltage	DC 3 V
Battery type	1×Lithium CR 2450N
Ambient temperature	-5 ... +45 °C
Degree of protection	IP 20
Dimensions L×W×H	
Order No. 5122 00	55×40.5×15 mm
Order No. 5124 00	93×53×15.5 mm
Relative humidity	max. 80 % (No moisture condensation)

KNX

KNX medium	RF1.R
Commissioning mode	S-mode
Radio frequency	868.3 MHz
Transmitting power	max. 20 mW
Transmitting range in free field	typ. 100 m

4 Software description

4.1 Software specification

ETS search paths: - Radio / Hand-held transmitter / RF remote control, 2-gang
 - Radio / Hand-held transmitter / RF remote control, 4-gang
Configuration: S-mode standard

Applications for 2x hand-held transmitter:

No.	Short description	Name	Version	from mask version
1	Application with 2 operating rocker switches and an LED as an actuation and status display.	RF hand-held transmitter, 2x D20111	1.1 From ETS5	27B0

Applications for 4x hand-held transmitter:

No.	Short description	Name	Version	from mask version
1	Application with 4 operating rocker switches and an LED as an actuation and status display.	RF hand-held transmitter, 4x D20211	1.1 From ETS5	27B0

4.2 Software "KNX RF Hand-held transmitter"

4.2.1 Scope of functions

Scope of functions

General:

- Actuation signalling and send/status display using a two-colour LED jointly for all buttons and status objects through a 2-level display function.
- The LED light period can be configured.
- Status display optionally via separate 1-bit status communication objects.
- Send/actuation display can be switched off.

"Switching" function:

- Rocker or button function
- Command on pressing and releasing the buttons can be configured (ON, OFF, TOGGLE, no reaction).

"Dimming" function:

- Rocker function
- Command on pressing the rocker switch (left and right button) can be configured (brighter - ON, darker - OFF).
- Time between switching and dimming can be set.

"Blind" function:

- Rocker function
- Command on pressing the rocker switch (left and right button) can be configured (UP, DOWN, TOGGLE).
- Time between short and long time commands and slat adjusting time can be set.

"Value transmitter" and "Scene extension" functions:

- Rocker function
- Command on pressing the rocker switch (left and right button) can be configured (values 0...255 / 0...100% or scene numbers).
- Storage function possible with scene extension.

4.2.2 Notes on software

Activation and status evaluation

The activation or status evaluation of cabled KNX systems (Medium TP) can be implemented using a media coupler, which is available as an accessory. Additionally or alternatively, suitable KNX RF actuators can be activated and evaluated directly by the KNX RF hand-held transmitter.

After the last operation, the device automatically switches to energy-saving mode after a specified time has elapsed. In energy-saving mode, the LED remains switched off. During operation, the energy saving mode is exited. The device then executes the programmed button commands.

ETS project design and commissioning

For project design and commissioning of the device, ETS5 is required. The necessary product database is offered in the *.KNXPROD format.

If the device is in energy-saving mode (the last operation was some time ago), then this must be actively terminated before the application program can be programmed by the ETS. This can be done by pressing a button or the programming button. The same applies to the unloading of the application program or reading out of the device information by the ETS.

Physical addresses and domain address

Different RF lines can be operated in a KNX system. The RF lines are separated logically (radio communication islands) and are each separately connected to the wired KNX media (e.g. TP) using media couplers. In accordance with the topology defined in the ETS project, devices assigned to the RF lines receive physical addresses. These physical addresses must suit the line address of the corresponding media coupler, as a media couple functions like an area line coupler (depending on the configuration) and can filter physical addresses.

In addition, a unique domain address is assigned to each RF line in the ETS. This is required so that devices can be grouped, topologically structured and commissioned in the same way in an open communication medium, such as KNX RF. Only devices with the same domain address can communicate with each other. As a result, a media coupler must always have the same domain address as a device in its subordinate RF line.

- i** A domain address is 6-bytes long and is entered in hexadecimal in the ETS or is generated automatically. After the first 2 bytes, the input notation requires a colon (when read from the left).
For example, a domain address could look like this: "0011:22334455" or "00FA:4F5B3122".
- i** RF lines of a joint KNX installation or of directly adjacent KNX installations in radio range may never have an identical domain address. The ETS offers a function for random assignment of domain addresses for RF lines, in order to avoid this improper situation. When the random function is used, the probability of multiple assignment of an identical address is more or less non-existent. Domain addresses automatically generated by the ETS are characterised by the hexadecimal characters "00FA..." (e.g. "00FA:4D6C3F58").

For an RF device to be programmed by the ETS, the domain address of the RF line must match the domain address of the KNX RF communication interface (e.g. KNX RF USB data interface or media coupler). Otherwise, the ETS will be unable to reach the KNX RF devices of the affected line. The domain address of the KNX RF data interface used by the ETS is configured in the general connection settings of the ETS. In an ETS project, the domain address of an RF line or a media coupler is configured in the line properties (separate for each RF line).

- i** The domain address is programmed automatically into the device by the ETS when the physical address is assigned (see page 7-8).

4.2.3 Object table

Number of communication objects:	Depends on the device variant and the set function. 4x: Max. 12, largest object number 20 2x: Max. 6, largest object number 18
Number of addresses (max):	100
Number of assignments (max):	100

Objects for "switching"

Function:	Switching				
Object	Function	Name	Type	DPT	Flag
 1, 3, 5, 7	Switching	Rocker 1-4 ¹	1-bit	1.xxx	C, W, T, A
Description	1-bit object for transmission of switching telegrams (ON, OFF).				

Objects for "dimming"

Function:	Switching				
Object	Function	Name	Type	DPT	Flag
 1, 3, 5, 7	Switching	Rocker 1-4 ¹	1-bit	1.xxx	C, W, T, A
Description	1-bit object for transmission of switching telegrams (ON, OFF).				

Function:	Dimming				
Object	Function	Name	Type	DPT	Flag
 9, 11, 13, 15	Dimming	Rocker 1-4 ¹	4-bit	3.007	C, W, T, A
Description	4-bit object for the transmission of relative dimming telegrams (dim brighter, dim darker).				

Objects for "Venetian blind"

Function:	Venetian blind				
Object	Function	Name	Type	DPT	Flag
 1, 3, 5, 7	Short time operation	Rocker 1-4 ¹	1-bit	1.007	C, -, T, A
Description	1-bit object for the transmission of telegrams with which a Venetian blind or shutter drive motor can be stopped or with which the blind slats can be adjusted by short time operation.				

1: The number of rockers or buttons depends on the planned device variant.

Function: Venetian blind

Object	Function	Name	Type	DPT	Flag
 9, 11, 13, 15	Long-time operation	Rocker 1-4 ¹	1-bit	1.008	C, W, T, A

Description 1-bit object for the transmission of telegrams with which a Venetian blind or shutter drive motor can be moved upwards or downwards.

Objects for "value transmitter"

Function: Value transmitter

Object	Function	Name	Type	DPT	Flag
 1, 3, 5, 7	Value	Rocker 1-4 ¹	1 byte	5.xxx	C, -, T, A

Description 1-byte object for the transmission of values from 0 to 255 (corresponding to values from 0 % to 100 %).

Objects for "scene extension"

Function: Scene extension

Object	Function	Name	Type	DPT	Flag
 1, 3, 5, 7	Scene extension	Rocker 1-4 ¹	1 byte	18.001	C, -, T, A

Description 1-byte object for recalling or for storing one of max. 64 scenes on an actuator, scene controller or scene push-button sensor.

Objects for "Status indication"

Function: Status indication

Object	Function	Name	Type	DPT	Flag
 17, 18, 19, 20	Switching	Rocker switch 1-4 status ¹	1-bit	1.xxx	C, W, -, A

Description 1-bit object for activation of the status LED (polarity and status evaluation can be configured).

1: The number of rockers or buttons depends on the planned device variant.

4.2.4 Functional description

4.2.4.1 Display functions

Operation and status display

The device has a two-coloured LED for indicating activation and status (red / green). This makes it possible to indicate successful operation and sending processes directly on the device. The bidirectional communication also makes it possible to temporarily indicate states of the KNX actuator immediately after an operation by means of the LED. For this purpose, the device has separate status communication objects.

The operating and display concept intends two phases of the LED display. In the first display phase, the user is given feedback on the button-press. Then, there is always a pause of 0.5 s, during which the LED is switched off. Then there is the second display phase, in which a received actuator status is displayed or - with the Scene extension function with memory function - the triggering of a memory telegram is signalled. In addition, transmission errors can be displayed.

- First display phase:
If a button is pressed, the red button-press display is activated for the illumination length set in the ETS. The display goes out after the set time has elapsed. A longer button-press (e.g. during dimming) or the release of the button has no further influence on the button-press display.
The send operation is monitored by the device during the first display phase. If a transmission error was detected (e.g. radio interference, communication object does not have a group address), then, in the second display phase, the LED flashes red to indicate a transmission error. The send operation is then cancelled.
The red send and actuation display can be optionally switched off. In the "Always OFF" setting, the parameter "Function of the red send and actuation LED" on the "General" parameter page means that there is no button-press display for any of the operating buttons. This deactivates the first display phase. However, the signalling of a transmission error in the second display phase and the display of a weak or void battery still functions. The display pause also remains active after the first phase, meaning that an actuator status is displayed at least 0.5 seconds after a button-press.
- Second display phase:
In the second display phase, the ON/OFF feedback of an actuator can be displayed. For this, each operating rocker has separate 1-bit LED communication objects. Any 1-bit feedback functions of the activated KNX actuators can be connected to these status objects. The parameters "Status display function" on the "Status" parameter pages of each operating rocker define whether the status display is used. In the "Always OFF" setting, the status function of the appropriate rocker switch, and thus the second display phase, is deactivated. In the "LED Object..." settings, the status object of a rocker switch is available. When selecting the setting, it is also possible to define which object status is displayed by the LED (ON / OFF / ON and OFF) and in which colour the status is shown.
Just as in the first display phase, the LED for the status display lights up for the illumination period generally set in the ETS.
If, during the first display phase, a transmission error was identified (telegram of the operating function could not be sent), then the LED does not display an actuator status in the second display phase. In this case, the error is signalled by the LED slowly flashing red for 3 seconds (Figure 10).

- i** In the "Switching" function, the operation concept can be configured as "Rocker function" or alternatively as "Push-button function". With the button function, a distinction is made as to whether a button pair is divided into two separate and functionally-independent buttons (double-button operation, e.g. activating two actuator channels), or whether it works as a single "large" button (single-button operation, only activate one actuator channel). With double-button operation, each button pair can possess two status objects (left button, right button). This means that different actuator feedback can be signalled. However, it should be ensured that both status objects activate the same status LED. The display functions of both buttons of a control surface do not override each other. A new button-press always interrupts an executed display function immediately (Figure 9). With the single-button operation or with the rocker switch function, only one status object is available for each button pair.
- i** The status display function is functionally dependent on the telegram sequence of the configured operating function (Switching, Dimming, Venetian blind...). The "Rocker switch and button functions" chapter of this documentation describes the functional dependencies in more detail (see page 23).

In the second display phase of the LED, it is possible to signal the status of an actuator channel as a single status (Figure 3) or, alternatively, as a double status (Figure 4). With the display of a single status, only the ON or OFF status is signalled by the illumination of the LED. With the double status, both the ON and OFF statuses are evaluated by the transmitter using a sequential, two-colour display. The "Status display function" parameter on the "Status" parameter pages specifies which status of the 1-bit feedback should be displayed and in which LED colour this status is to be displayed.

Due to the energy-saving operation of the transmitter, the actuator feedback must be received in a defined time window after the button operation. This time is defined individually for each rocker switch by the parameter "Time window for status display" (1...120 s). With each telegram that the device sends successfully on a button-press, the time window configured in the ETS for the status display is retriggered (Figure 5).

After the time has elapsed, the transmitter switches back to energy-saving mode. Feedback telegrams arriving at the device outside the defined time window for the status display are not evaluated by the LED.

- i** During an open time window, the device remains ready to receive, even telegrams coming from the ETS. This means that any button-press can open a time window for an ETS programming operation.

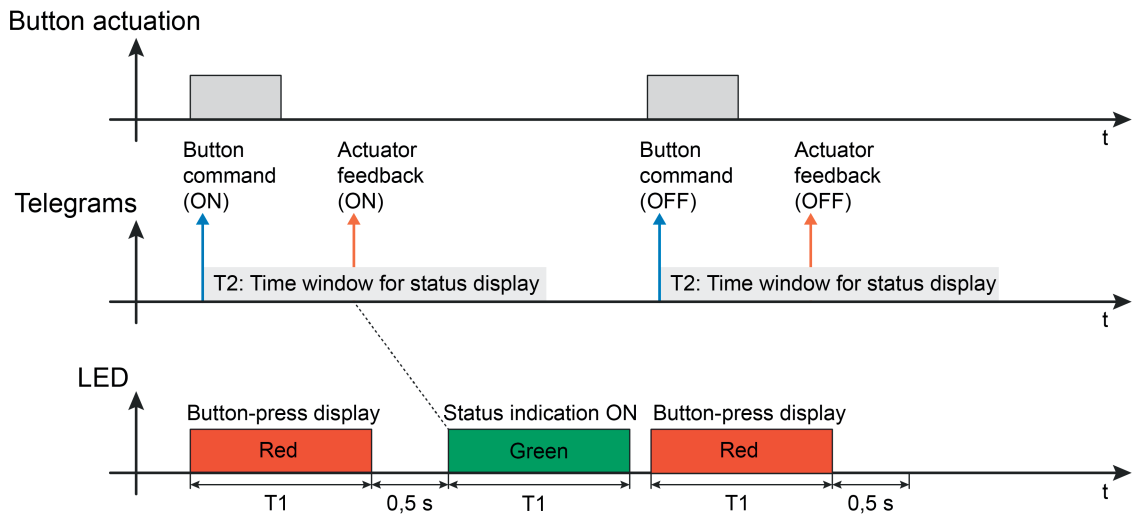

Figure 3: Example of a two-level actuation and status display with single status Status display state "ON" through green LED

- T1 Time according to the parameter "Lighting time of all LEDs" (global for all operating rocker switches)
- T2 Time according to the parameter "Time window for actuator feedback" (separate for each button)

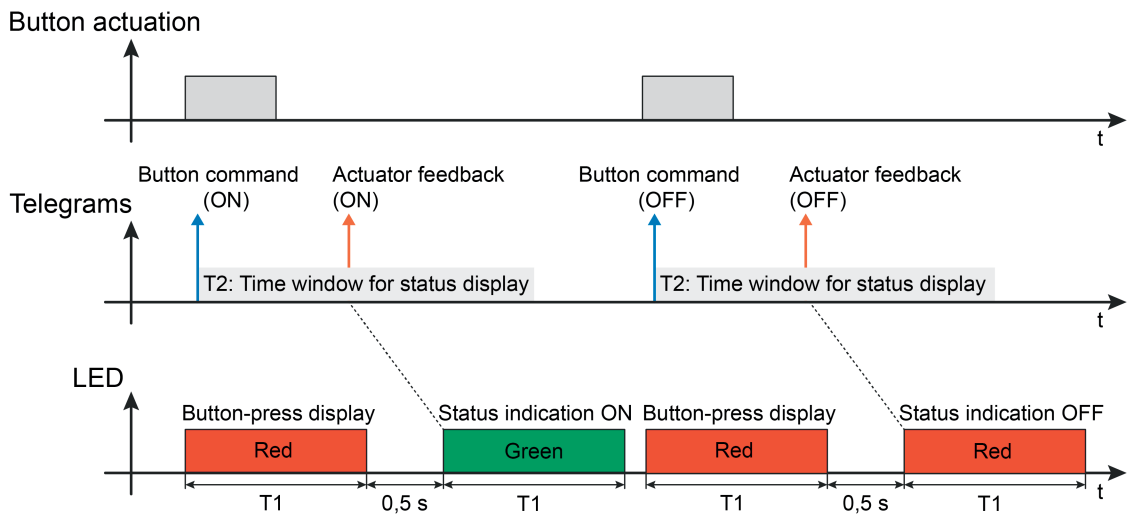

Figure 4: Example of a two-level actuation and status display with double status Status display state "ON" and "OFF" through green and red LED

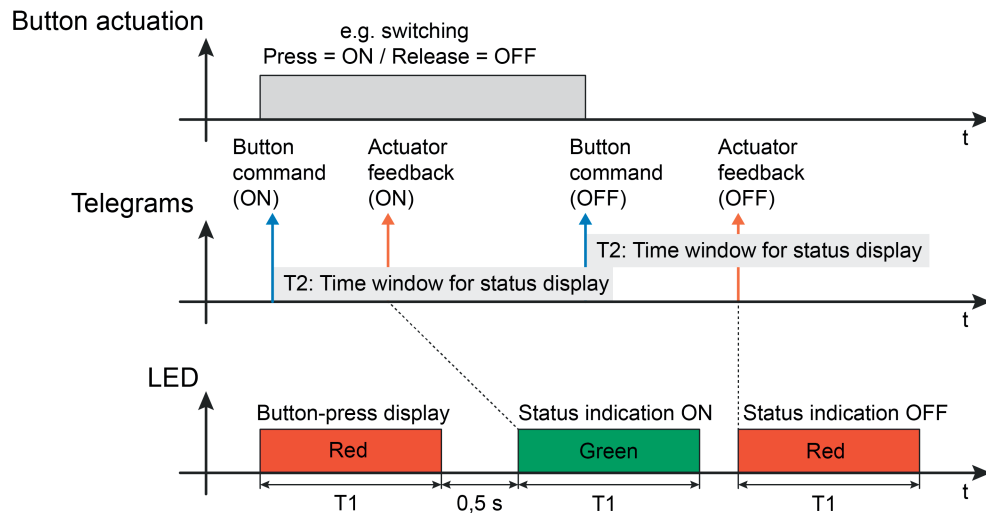

Figure 5: Example of a two-level actuation and status display with double status
New time window for status display through multiple operating telegrams

Each telegram that the transmitter has triggered through continued operation will always trigger a new time window for status display. The device terminates a status display of the first time window executed by the LED if, during this time, new actuator feedback is received in the second time window (Figure 6).

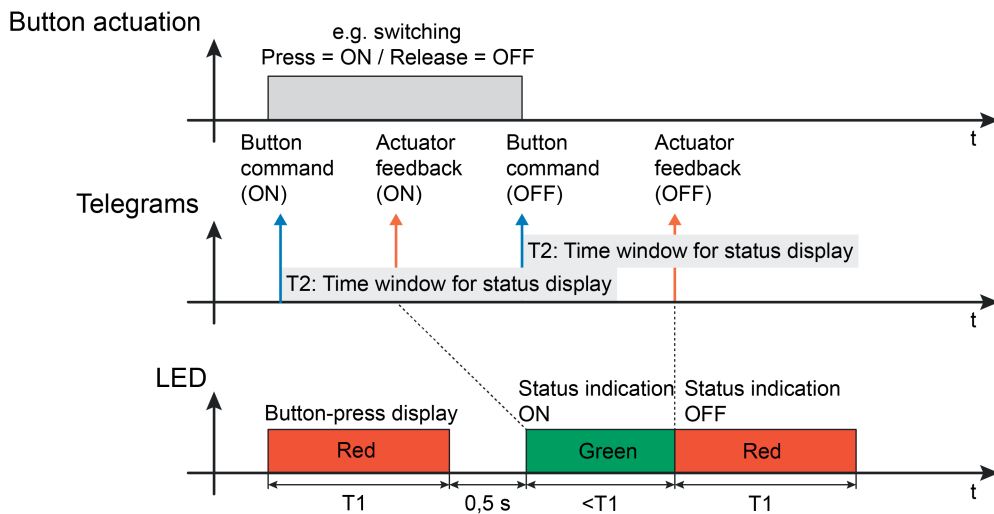

Figure 6: Example of a two-level actuation and status display with double status
Interruption of the first status display through the actuator status in the new time window

The parameters "Terminate time window for status display after first actuator feedback ?" on the "Status" parameter pages define whether, within a time window for status display, only the first actuator feedback is evaluated and has an LED display or whether additional feedback telegrams will be displayed during the same time period. In the "No" setting, all the feedback is evaluated within the specified time window. Any received feedback telegram will trigger the status display according to the configured polarity (ON and/or OFF), according to the defined colour (Figure 7).

In the "Yes" setting, only the first actuator status telegram received by the transmitter in the time

window of the status display is displayed. At the same time, the transmitter ends the time window. As a result, any further status telegrams are ignored (Figure 8).

- i** The "No" setting is particularly useful when time functions, triggered by the transmitter, are running in the activated actuator. Here, the time window for the status display should be defined to be sufficiently long so that both actuator statuses (ON -> OFF) can be displayed within a time period.

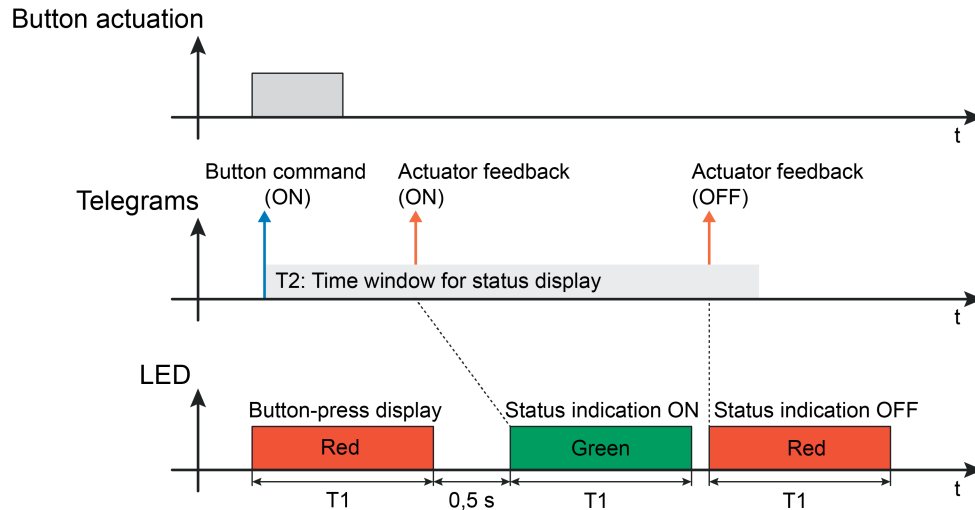

Figure 7: Example of a two-level actuation and status display with double status
Reception of two actuator status messages in time window permitted

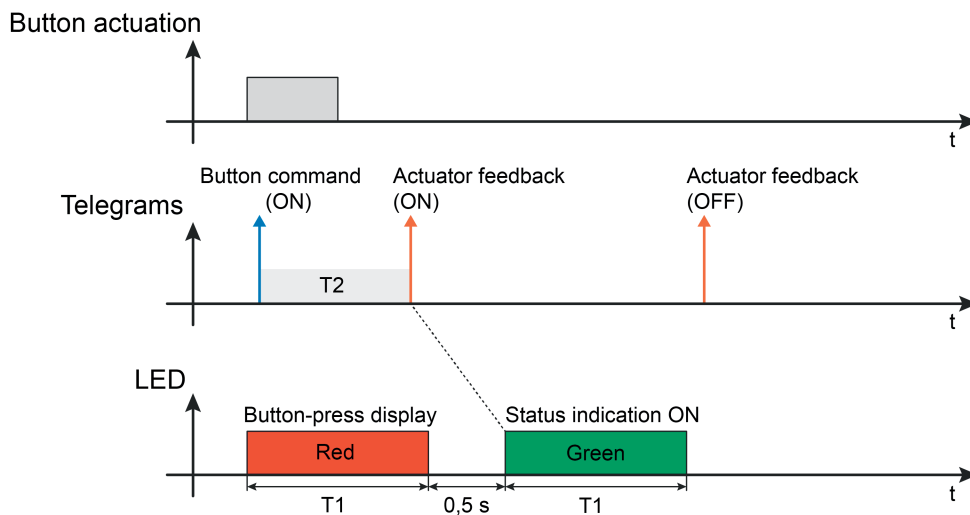

Figure 8: Example of a two-level actuation and status display with double status
Reception of two actuator status messages in time window not permitted

All the status functions of the operating rockers of the device only activate a shared LED. A new button-press of the same (most recently pressed) button or another button will interrupt the executed display function immediately and at any time. The LED immediately indicates the new display phase according to the last button-press (Figure 9). Cancellation can also occur if no status has been signalled for the started display function.

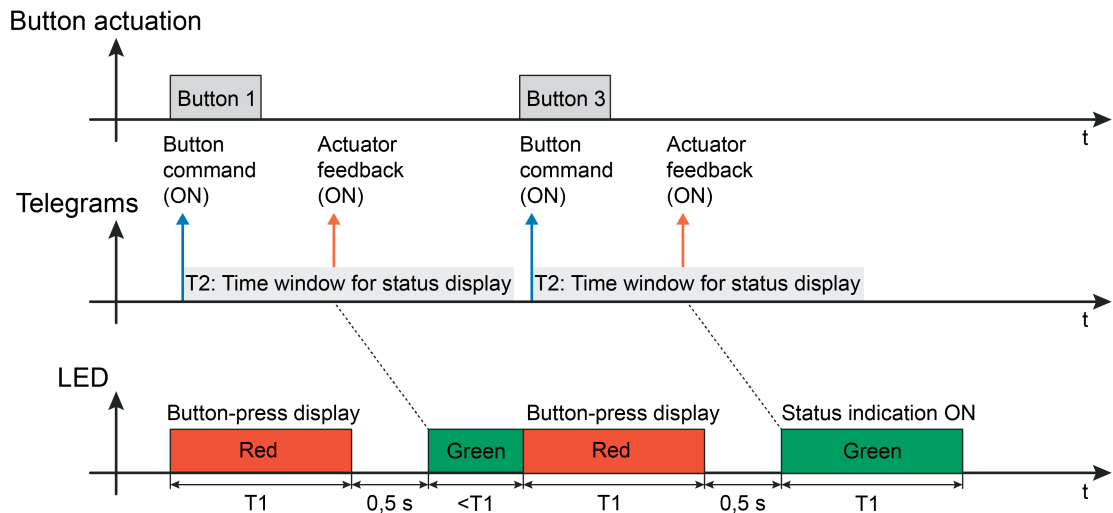

Figure 9: Example of a two-level actuation and status display
Interruption of the display function through new button actuation

Display of transmission errors

The LED of the device displays a transmission error. The send operation of a telegram is monitored by the device after a button-press. If the device was unable to send a radio telegram 5 seconds after the button-press (e.g. radio fault, communication object has no group address), then the LED will display an error by flashing red slowly for 3 seconds. All the other display functions (actuator status) are then suppressed.

The display of a transmission error also takes place when the function of the red send and actuation LED is switched off (parameter "Function of the red send and actuation LED?" set to "Always OFF").

Immediately after a button-press, the LED turns red to display an actuation, if enabled in the parameters. This also occurs if a transmission error is detected later on.

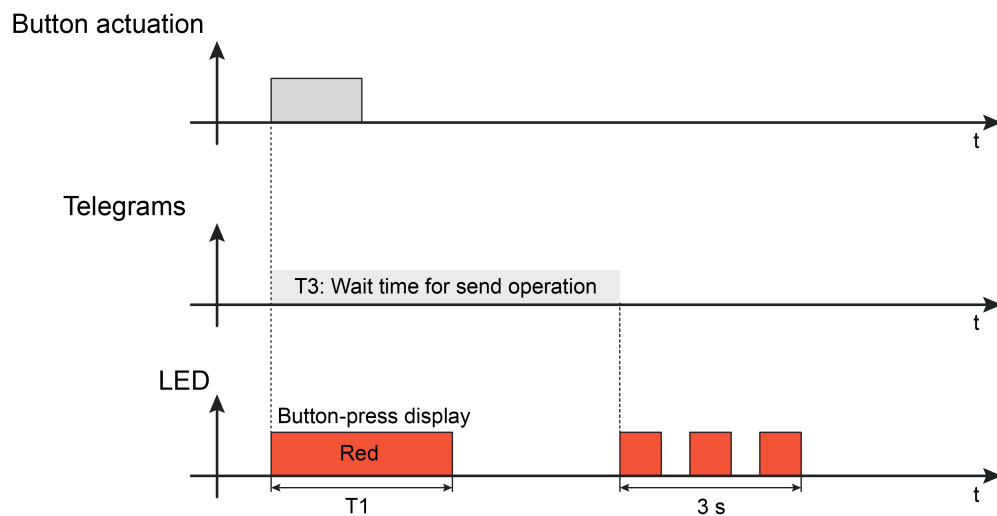

Figure 10: LED display in the case of a transmission error

T3 Wait time for send operation (permanently set to 5 seconds)

Battery display

When a button is pressed, the device checks the battery. If a weak or discharged battery is detected, then, after a button-press, the LED will flash in red immediately for a period of approx. 3 seconds at a frequency of approx. 0.75 Hz. In the case of such a display, replace the battery with a new one as soon as possible (see page 7).

- i A configured status display (second display phase) is not influenced by the battery display.
- i The battery display is activated as an alternative to the button-press display after a button-press. Battery display also occurs when the function of the red send and actuation LED is configured as "Always OFF".

4.2.4.2 Rockers and button functions

The following section contains descriptions of the various operating functions that can be configured individually for each rocker switch. The display function using the two-colour LED of the device is also influenced by the operating functions, which is why, in the following chapters, the function-specific LED functions are also described.

4.2.4.2.1 Switching function

The hand-held transmitter has 4 or 8 buttons, depending on the device variant. As a pair, two adjacent buttons each form one operating rocker switch. The operation concept of a button pair can be configured in the ETS using the "Switching" function either as a rocker switch function or alternatively as a push-button function.

- Rocker switch function:
If a button pair is used as a rocker switch, both buttons jointly affect the communication object assigned to the rocker switch. This can cause an actuator channel to be activated. Usually, pressing both sides of the rocker switch on the left or right can lead to directly opposite commands (e.g. switching: up ON - down OFF). Generally, the commands when the rocker switch is pressed or released at the top and bottom should be defined independently of each other.
- Button function:
With a button function, both buttons affect separate communication objects, independently of one another. As a result, two actuator channels can be activated by a button pair. With the push-button function, a distinction is made as to whether the button pair is divided into two functionally-independent buttons (double-button operation), or whether it works as a single "large" button (single-button operation). The parameter "Button evaluation" configures either double-surface or single-surface operation for each button pair. A control surface is always created in the ETS as a rocker switch (button pair). However, because in single-surface operation only one button functionally exists, the second button of the button pair has no function and is physically not present. During projecting in the ETS it is shown as a "not present" button without any further button parameters.

When using the rocker switch and button function, it is possible to define through the use of the parameter "Command on pressing the rocker switch / button" or "Command on releasing the rocker switch / button" which switching command sends the appropriate communication object. This means that a simple switching function (ON, OFF, TOGGLE) can be implemented, as can ON/OFF buttons (e.g. bell push-button function - press button ON, release button OFF). No distinction is made between a brief or long actuation in the "Switching" function.

The device has a two-coloured LED for indicating activation and status (red / green). This makes it possible to indicate successful operation and sending processes directly on the device. The bidirectional communication also makes it possible to temporarily indicate states of the KNX actuator immediately after an operation by means of the LED. For this purpose, the device has separate status communication objects.

If the LED status function of a rocker switch is being used, then the pressing and releasing of a button has an impact on the evaluation of the status information. If a telegram is only sent when a button is pressed, the transmitter only activates a time window for status display (Figure 11). If the device sends a telegram on pressing and releasing, then the time window for status display is triggered twice. This means that, in the thus extended time, the device can receive status telegrams of the actuators as a reaction to the different operating specifications and display them (Figure 12).

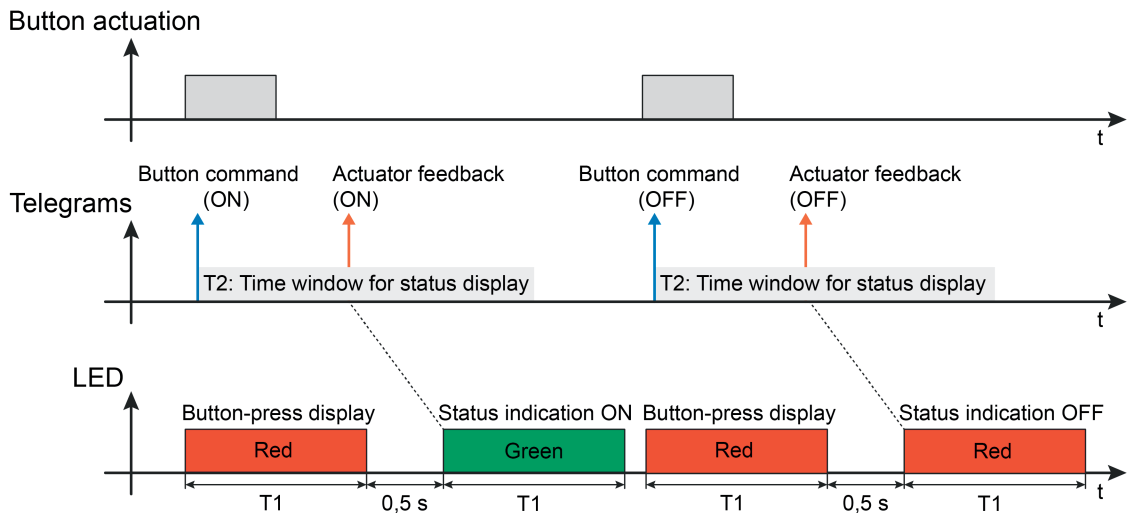

Figure 11: Example of a status display with the operating function "Switching" with double status (ON and OFF)
Telegram on pressing the button

- T1 Time according to the parameter "Lighting time of all LEDs" (global for all operating rocker switches)
- T2 Time according to the parameter "Time window for actuator feedback" (separate for each button)

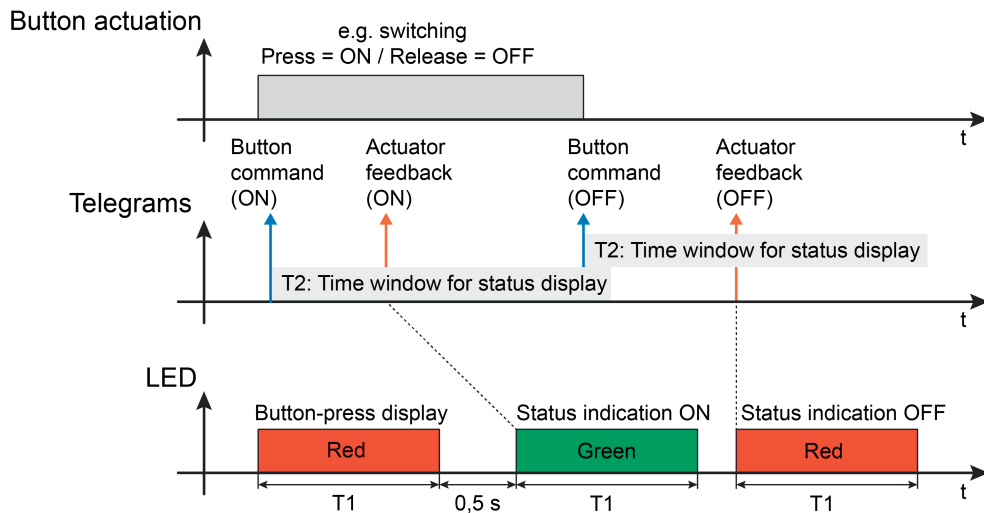

Figure 12: Example of a status display with the operating function "Switching" with double status (ON and OFF)
Telegram on pressing and releasing the button

- i** With the push-button function and double-button operation, each control surface can possess two status objects (left button, right button). This means that different actuator feedback can be signalled. However, it should be ensured that both status objects activate the same status LED. The display functions of both buttons of a control surface do not override each other. A new button-press always interrupts an executed display function immediately.
With the push-button function and single-button operation or with the rocker switch function, only one status object is available for each control surface.
- i** Refer to the chapter "Display functions" of this documentation for application principles and supplementary information on the LED display (see page 16).

4.2.4.2.2 Dimming function

For each rocker switch with the function set to "Dimming", the ETS indicates a 1-bit object and a 4-bit object. Generally, the device transmits a switching telegram after a brief press and a dimming telegram after a long press. A telegram for stopping the dimming process is always sent when releasing the push-button after a long press. The length of time the button operation must last until it is detected as a long actuation can be set using the parameters "Time between switching and dimming".

The parameters "Command on pressing rocker..." define the operating command output on a short and long button-press ("Brighter (ON)", "Darker (OFF)"). Here, any command can be assigned to the left or right button of the rocker switch.

In dimming mode, the device transmits a telegram at the beginning of an actuation in order to start the dimming process (dimming step width 100%). A stop telegram is triggered at the end of operation. No telegram repetition occurs.

The device has a two-coloured LED for indicating activation and status (red / green). This makes it possible to indicate successful operation and sending processes directly on the device. The bidirectional communication also makes it possible to temporarily indicate states of the KNX actuator immediately after an operation by means of the LED. For this purpose, the device has separate status communication objects.

If the LED status function of a rocker switch is being used, then the short and long operation of a button have different impacts on the evaluation of the status information. With a short button-press (Switching), only a time window is triggered for status display (Figure 13). With a longer operation (Dimming), two time windows are activated, to be able to react to status changes after the Stop telegram (Figure 14), should status changes occur.

- i** Ideally, the 1-bit feedback object of the switching status of KNX dimming actuators is linked to the status object of the transmitter. The time window for the status display should, ideally, be at least as long as the dimming operation from the OFF status up to the maximum brightness.

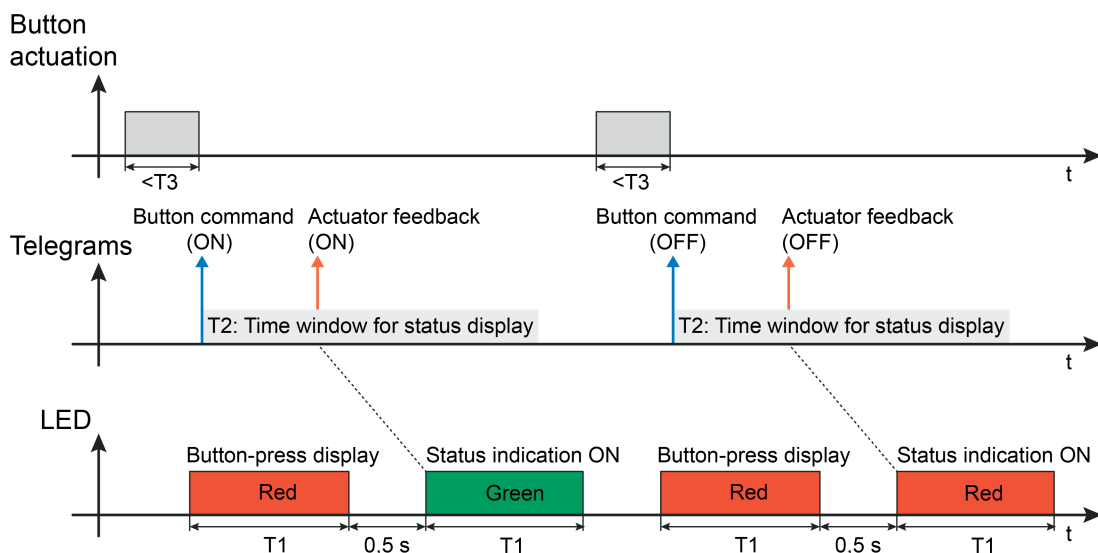

Figure 13: Example of a status display with the operating function "Dimming" with a short button-press (with double status ON and OFF)

- T1 Time according to the parameter "Lighting time of all LEDs" (global for all operating rocker switches)
- T2 Time according to the parameter "Time window for actuator feedback" (separate for each button)
- T3 Time between switching and dimming

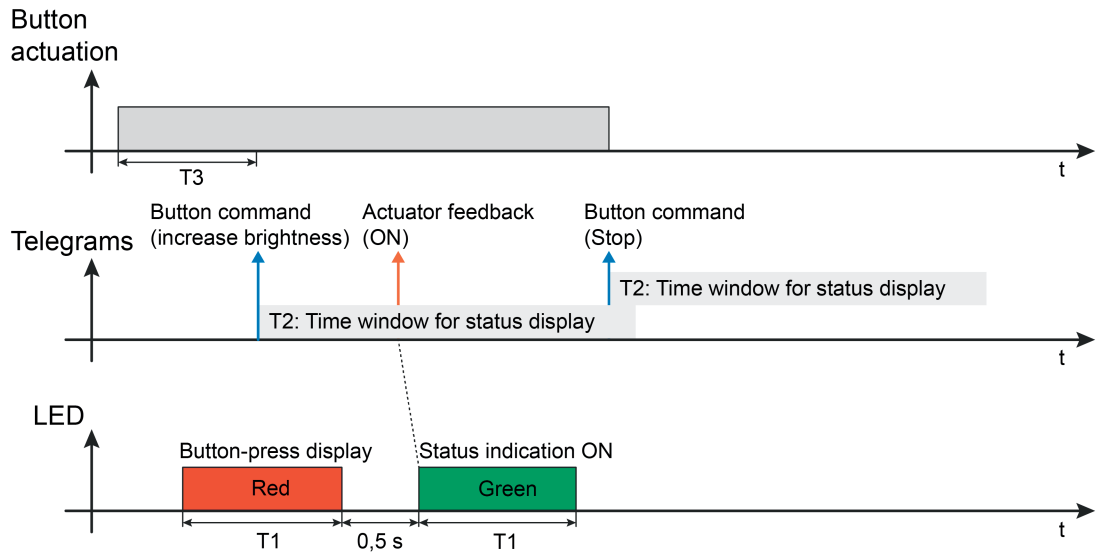

Figure 14: Example of a status display with the operating function "Dimming" with a long button-press

i Refer to the chapter "Display functions" of this documentation for application principles and supplementary information on the LED display (see page 16).

4.2.4.2.3 "Blind" function

For each rocker with the function set to "Venetian blind", the ETS indicates the two 1-bit objects "Short-time operation" and "Long-time operation". For the control of Venetian blind, roller shutter, awning or similar drives, the device supports the operation concept "Long - short or short", in which the telegrams are transmitted with variable time sequences.

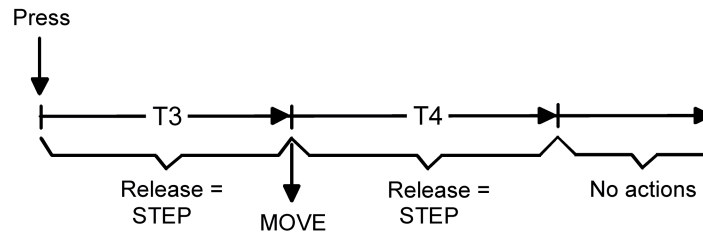

Figure 15: Operation concept "long – short or short"

When a button is pressed, the device shows the following behaviour:

- Immediately on pressing the button, the transmitter starts time T3 ("Time between short-time and long-time command") and waits. If the button is released again before T3 has elapsed, the device transmits a short-time telegram (STEP). This telegram can be used to stop a running drive. A stationary drive rotates the slats by one level.
- If the button is kept depressed after T3 has elapsed, the device transmits a long-time telegram (MOVE) and starts time T4 ("Slat adjusting time").
- If the button is released within T4, the device sends another short time telegram. This function is used for adjusting the slats of a blind. The function permits stopping the slats in any position during their rotation.
The "slat adjusting time" should be chosen as required by the drive for a complete rotation of the slats. If the "slat adjusting time" is selected longer than the complete running time of the drive, a push button function is possible as well. This means that the drive is active only when the button is kept depressed.
- If the button is kept depressed for longer than T4, the device transmits no further telegram. The drive remains on until the end position is reached.

The parameters "Command on pressing rocker..." define the operating command output on a short and long button-press ("DOWN", "UP", "TOGGLE"). Here, any command can be assigned to the left or right button of the rocker switch.

The device has a two-coloured LED for indicating activation and status (red / green). This makes it possible to indicate successful operation and sending processes directly on the device. The bidirectional communication also makes it possible to temporarily indicate states of the KNX actuator immediately after an operation by means of the LED. For this purpose, the device has separate status communication objects.

If the LED status function of a rocker switch is being used, then the short and long operation of a button have different impacts on the evaluation of the status information. With a short button-press (only STEP), only a time window is triggered for status display (Figure 16). With a longer operation (MOVE plus STEP during the slat adjusting time), two time windows are optionally activated to be able to react to status changes after the STEP telegram (Figure 17), should status changes occur.

- i** Ideally, the 1-bit feedback object of the drive movement of KNX Venetian blind or roller shutter actuators is linked to the status object of the transmitter (drive movement = ON, no drive movement / stop = OFF). In order to display the actuator feedback "ON" and "OFF" securely, the time window for the status display should be at least as long as the blind/shutter movement of the drive from the lower to the upper end position. Here, it should be noted that long-time windows have a negative influence on the lifespan of the battery. If only the "ON" status (drive movement is being executed) is to be displayed as a status, then the time windows for status display can be made shorter (approx. 3...5 seconds).

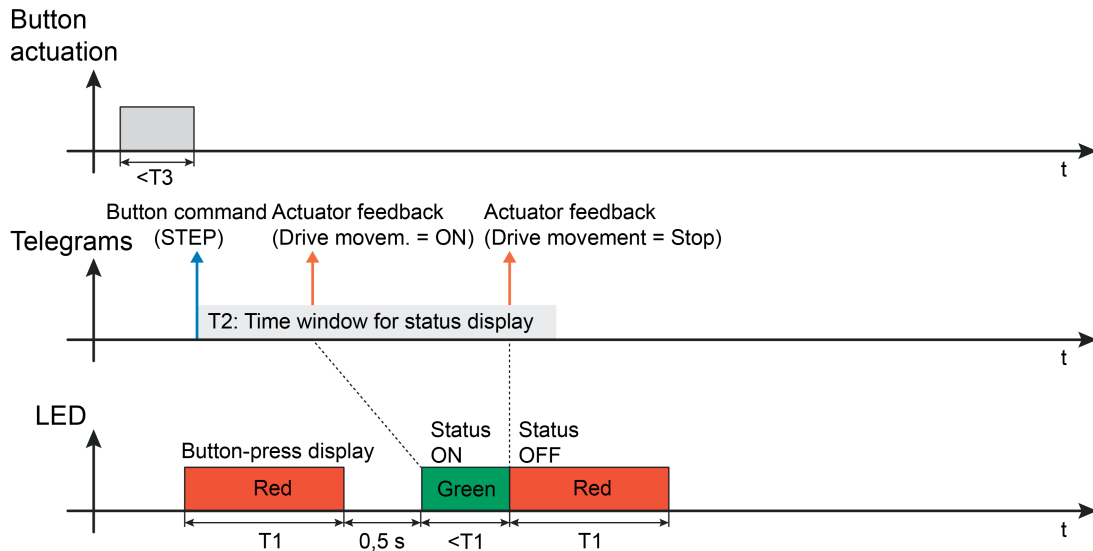

Figure 16: Example of a status display with the operating function "Venetian blind" with a short button-press (with double status ON and OFF)

- T1 Time according to the parameter "Lighting time of all LEDs" (global for all operating rocker switches)
- T2 Time according to the parameter "Time window for actuator feedback" (separate for each button)
- T3 Time between short-time and long-time command

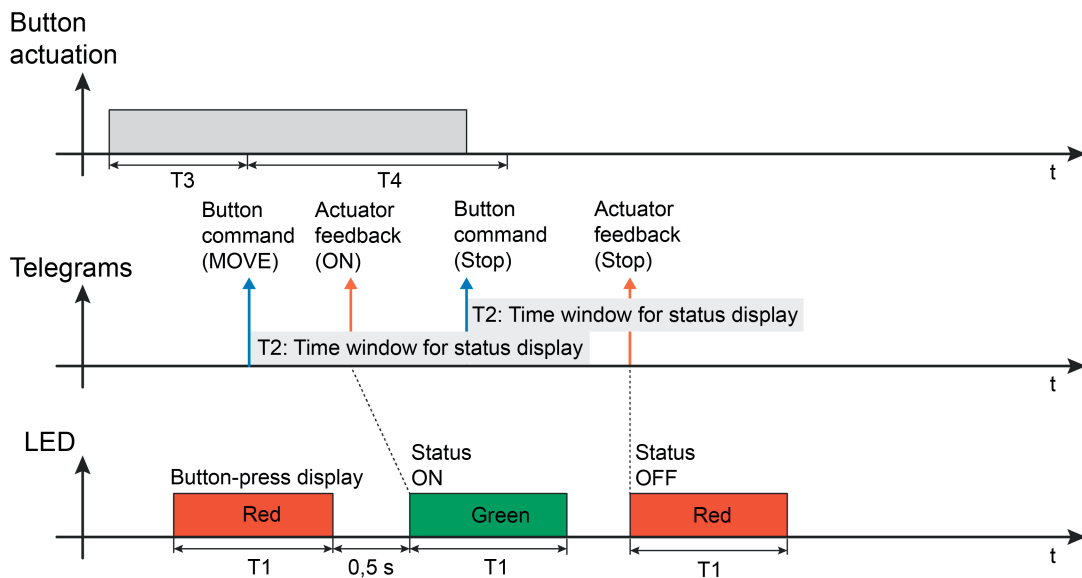

Figure 17: Example of a status display with the operating function "Venetian blind" with a long button-press

- T4 Slat adjusting time
- i** Refer to the chapter "Display functions" of this documentation for application principles and supplementary information on the LED display (see page 16).

4.2.4.2.4 Function "Value transmitter 1 byte"

If the rocker switch function is configured to "Value transmitter 1 byte", then the ETS will display a 1-byte object. On pressing a button, the configured value is transmitted to the bus. It is possible to configure different values for both buttons of a rocker switch.

The "Function" parameter determines which value transmitter data format is to be used. The device can optionally transmit integers from 0...255 or relative values within a range of 0...100% (e.g. as dimming value transmitter).

Function	Lower numerical limit	Upper numerical limit
Value transmitter 0...255	0	255
Value transmitter 0...100 %	0 % (value = 0)	100 % (value = 255)

Data format of the different value transmitters

The device has a two-coloured LED for indicating activation and status (red / green). This makes it possible to indicate successful operation and sending processes directly on the device. The bidirectional communication also makes it possible to temporarily indicate states of the KNX actuator immediately after an operation by means of the LED. For this purpose, the device has separate status communication objects.

If the LED status function of a rocker switch is being used, then only the pressing of a button has an impact on the evaluation of the status information with the value transmitter. With a button-press, the transmitter activates the time window for the status display (Figure 18).

- i Ideally, the 1-bit feedback object of the switching status of, for example, KNX dimming actuators is linked to the status object of the transmitter. The time window for the status display should, ideally, be at least as long as the dimming operation from the OFF status up to the maximum brightness, so that it is possible to react to all the brightness value changes. With other value transmitter applications (e.g. limit value specifications), it is usually possible to do without a status display.

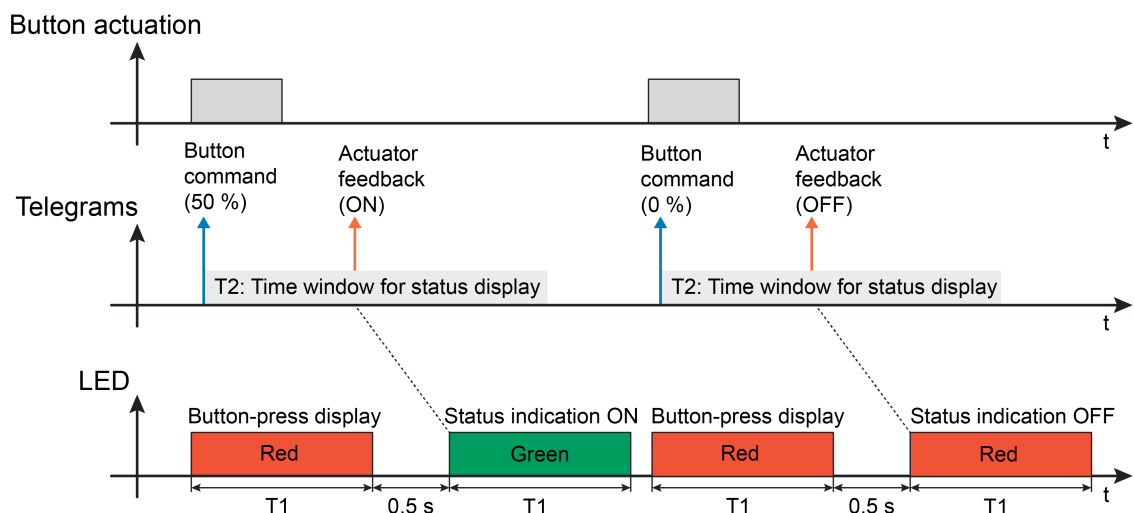

Figure 18: Example of a status display with the operating function "Value transmitter 1-byte" with double status (ON and OFF) Telegram on pressing the button

T1 Time according to the parameter "Lighting time of all LEDs" (global for all operating rocker switches)

- T2 Time according to the parameter "Time window for actuator feedback" (separate for each button)
- i** Refer to the chapter "Display functions" of this documentation for application principles and supplementary information on the LED display (see page 16).

4.2.4.2.5 Scene extension function

With the rocker switch function set to "Scene extension", which possesses a 1-byte communication object according to the KNX data point type 18.001, the ETS shows the "Function" parameter which distinguishes between the following settings...

- "Scene extension without storage function",
- "Scene extension with storage function",

In the scene extension function, the device transmits a preset scene number (1...64) via a communication object to the bus after a button-press. This feature permits recalling scenes stored in other devices and also storing them, if the storage function is used.

In the setting "... without storage function", a button-press triggers the simple recall of a scene. A long button-press has no further effect.

In the setting "... with storage function", the length of the actuation is monitored. A button-press of less than a second results in a simple recall of the scene, as described. After a button-press of more than five seconds, the device generates a storage instruction. In so doing, a storage telegram is transmitted.

An operation lasting between one and five seconds will be discarded as invalid.

The "Scene number" parameters specify which of the maximum of 64 external scenes is to be activated after a button-press. For a rocker switch, your own scene numbers can be assigned to each button.

The device has a two-coloured LED for indicating activation and status (red / green). This makes it possible to indicate successful operation and sending processes directly on the device. The bidirectional communication also makes it possible to temporarily indicate states of the KNX actuator immediately after an operation by means of the LED. For this purpose, the device has separate status communication objects. In the Scene extension operating function, it is also possible to configure telegram acknowledgement. In this case, successfully sent scene storage telegrams are signalled by the LED.

If the LED status display is used for the scene extension without a storage function, then brief operation of a button has an impact on the evaluation of the actuator feedback. With a short button-press (scene recall), only a time window is triggered for status display (Figure 19). With the scene extension with storage function, the time window for the status display is only activated when the storage telegram has been sent (Figure 20). This means that, after the storage command has been sent, a reaction can be given to actuator feedback. The LED can then, for example, signal a successful storage command if such actuator feedback is available. With the LED function "Telegram acknowledgement", the LED lights up in green after the successful sending of a storage telegram for a period of 3 seconds (Figure 21). Telegram acknowledgement does not take place if the storage telegram could not be sent. The illumination length and the colour of this display function is defined and thus cannot be changed.

- i** If the status display is used, ideally the 1-bit feedback object of the switching status of KNX switching or dimming actuators is linked to the status object of the transmitter.
- i** Telegram acknowledgement can only be designed for the scene extension with memory function.

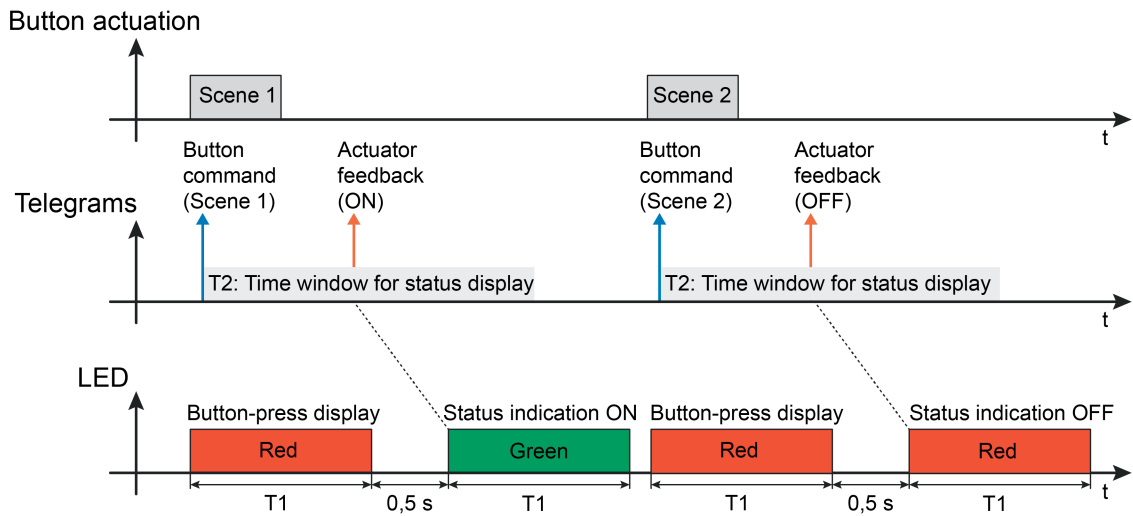

Figure 19: Example of a status display with the operating function "Scene extension" Scene extension without storage function (with double status ON and OFF)

- T1 Time according to the parameter "Lighting time of all LEDs" (global for all operating rocker switches)
- T2 Time according to the parameter "Time window for actuator feedback" (separate for each button)

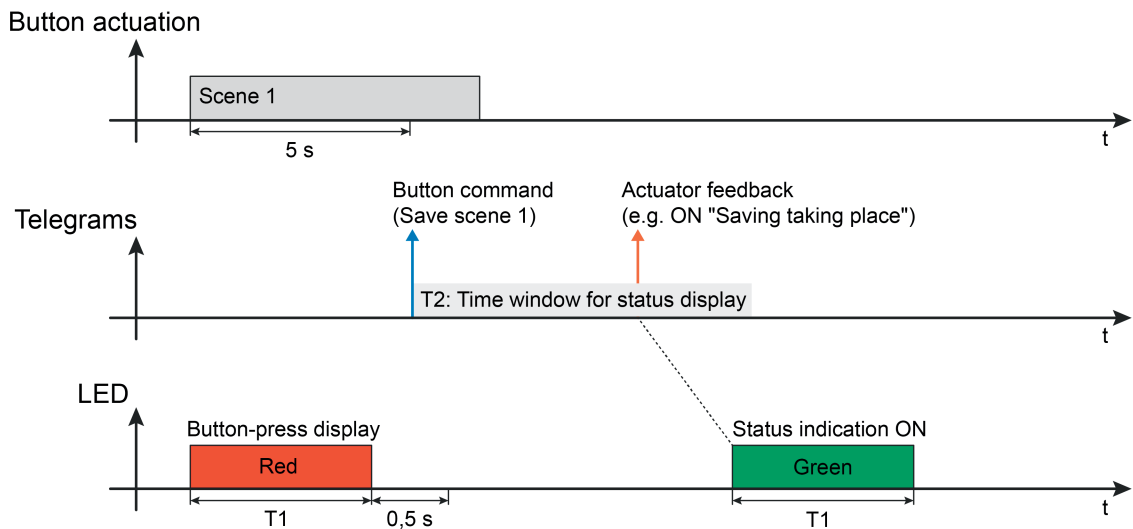

Figure 20: Example of a status display with the operating function "Scene extension" Scene extension with memory function and status display (with single status ON)

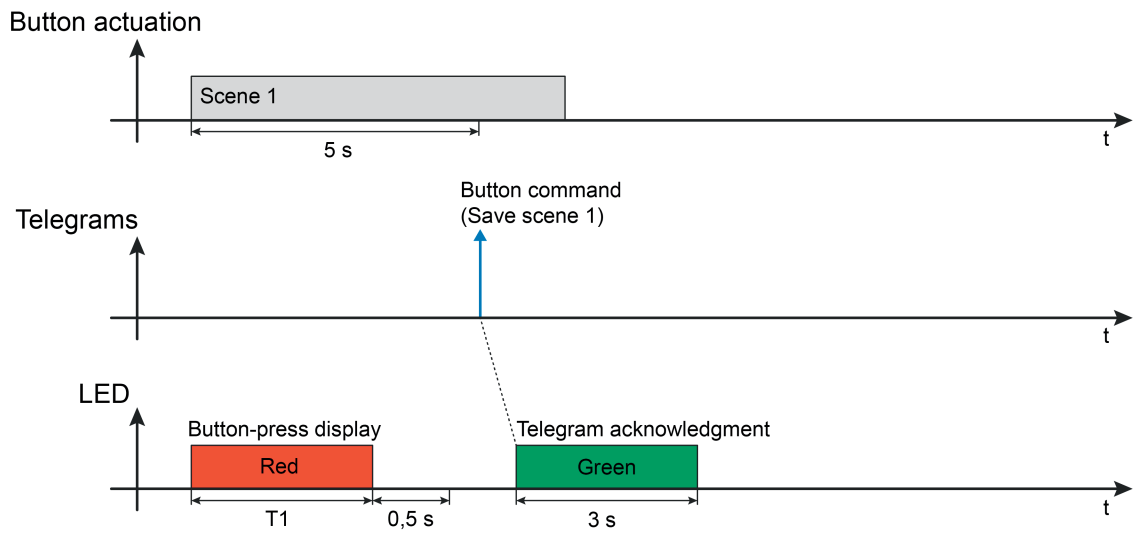

Figure 21: Example of an LED display with the operating function "Scene extension"
Scene extension with memory function and telegram acknowledgement

4.2.4.3 Delivery state

In the delivery state, the device does not function. No radio telegram is transmitted when a button is pressed. The LED lights up briefly and changes colour between red and green. The LED turns red to indicate the programming state, provided that it is activated.

4.2.5 Parameters

Description	Values	Comment
<p>☐ General</p>		
<p>Illumination length of all LEDs</p>	<p>1 sec 2 sec 3 sec 4 sec 5 sec</p>	<p>This defines the switch-on time of the LED for an actuation and status display.</p>
<p>Function of the red send and actuation LED</p>	<p>always OFF ON for configured illumination length</p>	<p>The red send and actuation display can be optionally switched off. In the "Always OFF" setting, this parameter means that there is no actuation display for any of the operating buttons. This deactivates the first display phase. However, the signalling of a transmission error or an empty battery remains active. The display pause also remains active after the first phase, meaning that an actuator status is displayed at least 0.5 seconds after a button-press.</p>
<p>☐ Rocker switch x, function</p>		
<p>Function</p>	<p>no function Switching Dimming Venetian blind 1-byte value transmitter Scene extension</p>	<p>This parameter is used to define the operating function of the rocker switch.</p>
<p>These parameters are only visible for the function "Switching"...</p>		
<p>Operation concept</p>	<p>Button function Rocker function</p>	<p>With a button function, both pressure points of a control surface affect separate communication objects, independently of one another. As a result, two actuator channels can be activated by a control surface.</p> <p>If a control surface is used as a rocker switch, both pressure points jointly affect the communication object assigned to the rocker switch. This can cause an actuator channel to be activated. Usually, pressing both sides of the rocker switch at the top or bottom can lead to directly opposite commands (e.g. switching: top ON - bottom OFF). Generally, the commands when the rocker switch is pressed or released at the top and bottom should be defined independently of each other.</p>

Button evaluation	Single-button operation Double-button operation	With the push-button function, a distinction is made as to whether the control surface is divided into two functionally-independent buttons (double-button operation), or whether it works as a single "large" button (single-button operation). A control surface is always created in the ETS as a rocker switch (button pair). However, because in single-surface operation only one button functionally exists, the second button of the button pair has no function and is physically not present. During projecting in the ETS it is shown as a "not present" button without any further button parameters.
Command on pressing left rocker	no function ON OFF TOGGLE	These parameters specify the reaction when the left rocker is pressed or released.
Command on releasing left rocker	no function ON OFF TOGGLE	
Command on pressing right rocker	no function ON OFF TOGGLE	These parameters specify the reaction when the right rocker is pressed or released.
Command on releasing right rocker	no function ON OFF TOGGLE	

These parameters are only visible for the function "Dimming"...

Command on pressing left rocker	brighter (ON) darker (OFF)	This parameter defines the reaction when the left rocker is pressed.
Command on pressing right rocker	brighter (ON) darker (OFF)	This parameter defines the reaction when the right rocker is pressed.
Time between switching and dimming, left rocker (100...3000 x 1 ms)	100... 400 ...3000	This parameter defines for how long the left rocker must be pressed for the device to send a dimming telegram.
Time between switching and dimming, right rocker (100...3000 x 1 ms)	100... 400 ...3000	This parameter defines for how long the right rocker must be pressed for the device to send a dimming telegram.

These parameters are only visible for the function "Venetian blind"...

Command on pressing left rocker	DOWN UP TOGGLE	This parameter defines the running direction of a drive after a button-press on the left side of the rocker switch. If the setting is "TOGGLE", the direction is changed after each long time command. If several transmitters are to control the same drive, the long-time objects of the devices must be interlinked for a correct change of the running direction.
Command on pressing right rocker	DOWN UP TOGGLE	This parameter defines the running direction of a drive after a button-press on the right side of the rocker switch. If the setting is "TOGGLE", the direction is changed after each long time command. If several transmitters are to control the same drive, the long-time objects of the devices must be interlinked for a correct change of the running direction.
Time between short and long time command, left rocker (1...30 x 100 ms)	1... 4 ...30	This parameter sets the time after which the long-time operation will be evaluated on pressing the left button of the rocker.
Time between short and long time command,	1... 4 ...30	This parameter sets the time after which the long-time operation will be evaluated on pressing the right button of the

right rocker
(1...30 x 100 ms)

rocker.

Slat adjusting time, left rocker
(0...30 x 100 ms)

0...**5** ... 30

Time during which a transmitted long time telegram can be terminated by releasing the left button of the rocker (short time). This function serves to adjust the slats of a blind.

Slat adjusting time, right rocker
(0...30 x 100 ms)

0...**5** ... 30

Time during which a transmitted long time telegram can be terminated by releasing the right button of the rocker (short time). This function serves to adjust the slats of a blind.

These parameters are only visible for the function "Value transmitter 1-byte"...

Function

Value transmitter 0...255
Value transmitter 0...100 %

A rocker configured as "Value transmitter 1 byte" permits selecting whether the values to be transmitted are interpreted as integers from 0 to 255 or as a percentage from 0 % to 100 %. The following parameters and their settings depend on this distinction.

Value, left rocker

0...**255**

Defines the value when the left side of the rocker switch is pressed. Only for "Function = Value transmitter 0...255"!

Value, right rocker

0...255

Defines the value when the right side of the rocker switch is pressed. Only for "Function = Value transmitter 0...255"!

Value, left rocker

0...**100**

Defines the value when the left side of the rocker switch is pressed. Only for "Function = Value transmitter 0...100%"!

Value, right rocker

0...100

Defines the value when the right side of the rocker switch is pressed. Only for "Function = Value transmitter 0...100%"!

These parameters are only visible for the function "Scene extension"...

Function	Scene extension without storage function	With a rocker configured as a "Scene extension", there is the option of choosing whether only scenes are loaded or whether a storage function is possible.
	Scene extension with storage function	
Scene number, rocker switch left	1...64	Defines the scene number when the left side of the rocker switch is pressed.
Scene number, rocker switch right	1... 2 ...64	Defines the scene number when the right side of the rocker switch is pressed.

These parameters are visible for all functions...

Time window for operation Left rocker (0 = Continuous operation permitted) (0...250 s)	0... 30 ...250	If the left button of the rocker remains pressed for longer than the time defined by this parameter, then, to save the battery, the device evaluates the operation as invalid. The operation is ended correctly (e.g. by sending a Stop telegram during a dimming operation). The device then returns to energy-saving mode immediately. Only a new button-press wakes up the device again.
Time window for operation Right rocker (0 = Continuous operation permitted) (0...250 s)	0... 30 ...250	If the right button of the rocker remains pressed for longer than the time defined by this parameter, then, to save the battery, the device evaluates the operation as invalid. The operation is ended correctly (e.g. by sending a Stop telegram during a dimming operation). The device then returns to energy-saving mode immediately. Only a new button-press wakes up the device again.

Rocker switch x, status

Status display function	The device has a two-coloured LED for indicating activation and status (red / green). This makes it possible to indicate successful operation and sending processes directly on the device. The bidirectional communication also makes it possible to temporarily indicate states of the KNX actuator immediately after an operation by means of the LED. For this purpose, the device has separate status communication objects. The operating and display concept intends two phases of the LED display.
-------------------------	--

		In the first display phase, the user is given feedback on the button-press. Then, there is always a pause of 0.5 s, during which the LED is switched off. Then there is the second display phase, in which a received actuator status is displayed or - with the Scene extension function with memory function - the triggering of a memory telegram is signalled.
	always OFF	In the "Always OFF" setting, the status function of the appropriate rocker switch, and thus the second display phase, is deactivated.
	Telegram acknowledgment	With this LED function, the LED lights up in green after the successful sending of a storage telegram for a period of 3 seconds. Telegram acknowledgement does not take place if the storage telegram could not be sent. This setting is only available with the operating function "Scene extension".
	LED object (display of ON status only with green LED)	In this setting, the 1-bit status object is available. This means that, after an operation, switching status feedback of an actuator can be displayed in the second display phase of the LED. Only the ON status is evaluated as a single status and displayed by the LED turning green.
	LED object inverted (display of OFF status only with green LED)	In this setting, the 1-bit status object is available. This means that, after an operation, switching status feedback of an actuator can be displayed in the second display phase of the LED. Only the OFF status is evaluated as a single status and displayed by the LED turning green.
	LED object (display of ON and OFF status only with green and red LED)	In this setting, the 1-bit status object is available. This means that, after an operation, switching status feedback of an actuator can be displayed in the second display phase of the LED. The ON and OFF statuses are evaluated as a double status. The LED turns green for ON and red for OFF.
	LED object inverted (display of ON and OFF status only with green and red LED)	In this setting, the 1-bit status object is available. This means that, after an operation, switching status feedback of an actuator can be displayed in the second display phase of the LED. The ON and OFF statuses are evaluated as a double status. The LED turns green for OFF and red for ON.
Time window for status display of the actuator	1... 3 ...120	Due to the energy-saving operation of the transmitter, the actuator feedback

feedback
Rocker switch left
(1...120 s)

must be received in a defined time window after the button operation. This time is defined individually for the left side of the rocker switch by this parameter. Each telegram that the device sends successfully on a button-press retriggers the time window configured here for the status display. After the time has elapsed, the transmitter switches back to energy-saving mode. Feedback telegrams arriving at the device outside the defined time window for the status display are not evaluated by the LED.

Time window for status display of the actuator feedback
Rocker switch right
(1...120 s) 1...**3**...120

Due to the energy-saving operation of the transmitter, the actuator feedback must be received in a defined time window after the button operation. This time is defined individually for the right side of the rocker switch by this parameter. Each telegram that the device sends successfully on a button-press retriggers the time window configured here for the status display. After the time has elapsed, the transmitter switches back to energy-saving mode. Feedback telegrams arriving at the device outside the defined time window for the status display are not evaluated by the LED.

Terminate time window for status display after first actuator feedback ? yes
no

This parameter defines whether, within a time window for status display, only the first actuator feedback is evaluated and has an LED display or whether additional feedback telegrams will be displayed during the same time period. In the "No" setting, all the feedback is evaluated within the specified time window. Any received feedback telegram will trigger the status display according to the configured polarity (ON and/or OFF), according to the defined colour. In the "Yes" setting, only the first actuator status telegram received by the transmitter in the time window of the status display is displayed. At the same time, the transmitter ends the time window. As a result, any further status telegrams are ignored.

5 Appendix

5.1 Application basics

5.1.1 The KNX RF system

Introduction

The Gira KNX RF system (RF = Radio Frequency) is based on a manufacturer-independent KNX radio standard (868 MHz), with which existing KNX systems can be refitted or new installations can be expanded simply using RF components. Mobile hand-held transmitters allow easy operation of the intelligent KNX building functions via "remote control". RF pushbutton sensors can be mounted anywhere in which a control panel is required, no matter whether that is on stone, concrete, wood or glass walls or on the surfaces of furniture. KNX RF devices can be connected to wired KNX installations using media couplers. Additionally or alternatively, suitable RF actuators can be activated and evaluated directly by RF transmitters. Whilst TP or RF actuators are located where cables are present, cables are not relevant during the mounting of KNX RF pushbutton sensors and hand-held transmitters, as these Gira RF transmitters are battery-operated.

KNX RF components possess a transmit and receive module and are thus bidirectional. This means that it is possible, for example, to implement status displays on the RF control panels, in addition to the operating function, or to allow status feedback for actuators. In addition, bidirectional communication makes ETS commissioning possible.

Gira KNX RF hand-held transmitters and KNX RF pushbutton sensors are battery-operated. To prolong the life of the battery, the devices possess an energy-saving mode. After the last operation or after an ETS programming operation, the devices switch automatically to the energy-saving mode (semi-bidirectional operation) after a settable time. The devices temporarily have no function. If an RF device is in energy-saving mode, this mode must be actively terminated before a programming operation by the ETS is possible. This can usually be done by pressing a button or the programming button. The same applies to the unloading of the application program or reading out of the device information by the ETS.

- i** If energy-saving mode is active, the receiver of a semi-bidirectional RF device is switched off. In consequence, the device cannot receive any telegrams, meaning that status changes of group addresses cannot be tracked. In the case of hand-held transmitters or pushbutton sensors which are configured to the button function "Switching - TOGGLE", it can thus be necessary to press the button up to twice for the switching command (ON -> OFF / OFF -> ON) to be switched correctly.
- i** The ETS requires the user to press the programming button if no direct access to the devices is possible due to an active energy-saving mode.

Gira KNX RF devices correspond to the KNX standard "KNX RF1.R S-Mode". Devices of other manufacturers, which meet the same standard, are intercompatible. Frequently, for marketing reasons, different names or product designations are used for the same KNX RF system. The designations named below usually indicate, if necessary also in combinations, products of the same KNX standard.

- KNX RF1.R S-Mode
- KNX RF Ready S-Mode
- KNX RF 868 MHz
- KNX RF+

Approval and frequency use

KNX RF (KNX RF1.R) uses a frequency from the Europe-wide SRD band (SRD = Short Range Device). Low-power radio applications are used in this approval-free frequency range. Besides KNX RF, these include, for example, radio remote controllers, wireless microphones and headphones or other simple data transmission systems. KNX RF devices are generally

approved and can thus be used in all the states recognising the standards and directives of the European Union. In general, these include the EU and EFTA states.

The frequency band at 868 MHz as used by the KNX RF has good characteristics in buildings with respect to the signal distribution, since the attenuation due to walls, concrete reinforcements and metal parts keeps within reasonable limits.

Frequency	Transmitting power	Application (example)
26.9 ... 27.2 MHz	≤ 10 mW	PC devices, babyphones, model radio
40.6 ... 40.7 MHz	≤ 10 mW	Model radio
433.05 ... 434.79 MHz	≤ 10 mW	Motor vehicle remote controls, headphones, weather stations
446.0 ... 446.2 MHz	≤ 500 mW	PMR radio equipment
868.0 ... 868.6 MHz	0.5 ... 25 mW	KNX RF

Overview of standard SRD frequency bands

Besides the SRD frequency bands, there are additional frequency ranges provided for other radio services from different areas of application (e.g. analogue and digital audio and video transmission systems, Wi-Fi, Bluetooth). The division into frequency ranges according to the approved application is required for the range of different radio services to coexist and not interfere with one another.

The frequency range used by KNX RF is not exclusively available to the KNX radio service. In this frequency range too, there may be radio systems existing in parallel in a building, which have an influence on signal transmission. Through the joint use of a frequency range, it is possible that interference between the various radio services can occur, meaning the loss of transmitted information.

- i Besides available third-party radio services, other devices emitting electromagnetic waves (e.g. electrical machines, electronic ballasts and lighting, microwave ovens) may be potential sources of interference for KNX RF systems. This is then particularly problematic when the named devices are located in direct proximity to KNX RF devices. For this reason, sources of interference in immediate proximity to KNX RF devices during the planning of the electrical installation are to be avoided as far as possible.

Frequency	Transmitting power	Application (example)
868.0 ... 868.6 MHz	≤ 25 mW	Including radio alarm systems, garage door openers, eNet
2.40 ... 2.48 GHz	≤ 100 mW	WLAN, Bluetooth
5.725 ... 6.875 GHz	≤ 1,000 mW	WLAN

Overview of standard radio services in the same and neighbouring frequency ranges to KNX RF (also not SRD)

With KNX RF1.R, the mean frequency is specified as 868.3 MHz. Transmission power in the range 0.5...25 mW is possible. The system makes a communication channel available for all devices. The transmission time of each device (Duty-Cycle) is 1 % (maximum transmission time 0.6 seconds in one minute). This avoids continuous transmissions, meaning that the

transmission channel is not permanently blocked.

Control of media access

When it wishes to transmit a KNX telegram, each KNX RF transmitter checks whether the radio channel is already occupied by another RF transmitter (LBT: Listen Before Talk). If this is the case, the RF transmitter waits with the required radio transmission. It transmits its own telegram as soon as the radio channel is free again.

In addition, each RF transmitter waits for a short random interval on each transmission request, before the radio telegram is actually transmitted. This random time is of different length for each transmission operation. This suppresses to a great extent radio collisions between devices which actually wish to transmit simultaneously (e.g. media couplers, which have received a group telegram to be forwarded via the TP side), in combination with LBT.

The described transmission method for controlling media access generally prevents radio collisions in a KNX RF environment, but cannot exclude them completely. For example, it may occur that, in the case of a transmission between an RF transmitter (A) and an RF receiver (B), there is an additional RF transmitter (C), which is located within the range of the RF receiver, but cannot reach the other RF transmitter due to the spatial distance (Figure 22). In such a case, the two RF transmitters are unable to detect when the other transmits radio signals (Hidden Station Problem). In consequence, radio collisions can occur on the receiver located in the range of the two RF transmitters.

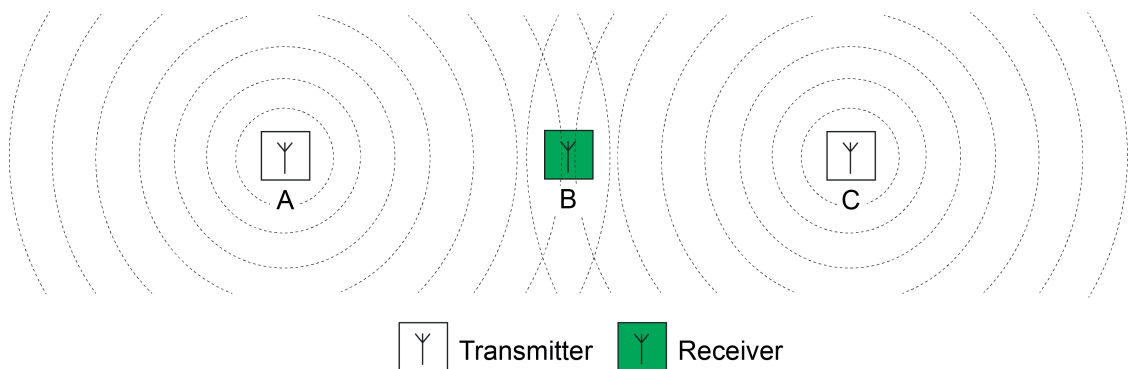

Figure 22: Radio collisions on the receiver due to the transmitter being too far away

The described effect is system-dependent and can be a particular problem when there are two or more media couplers in a KNX system. If the media couplers are out of the other's range, then they cannot detect whether another media coupler is already transmitting a group telegram. However, the KNX subscribers in the various RF lines can be located in such a way that they are in the overlap areas of the RF domains of the couplers. In consequence, the subscribers receive the colliding telegrams of multiple media couplers (Figure 33).

This circumstance must already be taken into account during the planning of a KNX RF system.

- If possible, position media couplers in such a way that they are within direct reception range of each other.
- Structurally decouple RF domains in such a way that their subscribers are only positioned in their own RF environment.
- Use repeaters instead of media couplers, if this is wise from a structural and topological point of view. Repeaters should be located within the range of the media coupler and also within the ranges of other repeaters.

i If complete separation of RF domains or the integration of media couplers into their radio ranges cannot be guaranteed structurally, then it may be better to create only one radio domain instead of multiple media couplers and to work with repeaters.

- i** Expert knowledge:
With KNX TP (TP = Twisted Pair), the bus access of a subscriber is controlled by the CSMA/CA method (Carrier Sense Multiple Access/Collision Avoidance). This bus access method avoids telegram collisions. In addition, received telegrams are confirmed by each addressed TP bus subscriber (telegram confirmation through LinkLayer-Confirm: Ack, Busy, Nack). This allows transmitters of KNX messages to detect whether potential receivers have understood the message or whether telegram repetitions are necessary due to transmission or processing errors.
These security mechanisms are not available within a KNX RF1.R radio domain, due to the specifications. If there are transmission errors, media couplers, which forward RF telegrams to the TP side, can repeat telegrams up to three times. Telegrams forwarded on the RF side are only transmitted once.
Media couplers can perform a telegram confirmation on the TP line for received telegrams. As described, this is not possible for telegrams received on the RF side.

5.1.2 Basic physical principles

Electromagnetic wave

Radio waves are waves of coupled electrical and magnetic fields (Figure 23). Electromagnetic waves are emitted by antennas into the surrounding area as free progressive waves. They do not require a special medium for radiation. In a vacuum, radio waves radiate at the speed of light. The radiation is always slower in other media. Like light, electromagnetic waves are subject to deflection, refraction, reflection, polarisation and interference.

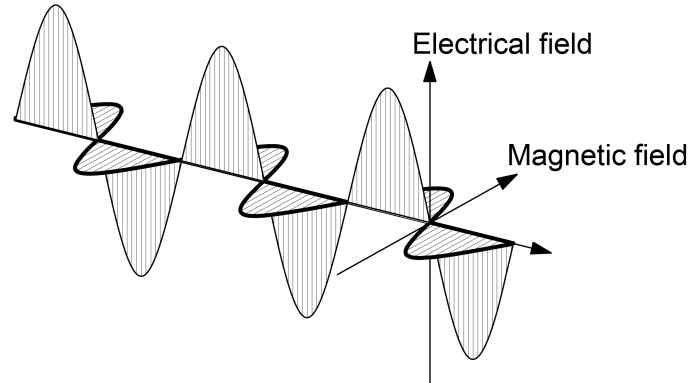

Figure 23: Model of an electromagnetic wave in an open space

Electromagnetic waves radiate out in a straight line in every direction. If multiple electromagnetic waves meet, then they will be superimposed. With KNX RF, the radio signals come from almost every direction (through the positioning of the transmitters and due to reflections). If KNX RF radio waves are superimposed, then noise is created (signal with an unspecific frequency spectrum) in the communication channel, which can no longer be understood by any KNX RF receiver. This can cause transmitted information to be lost. Therefore, when planning a KNX RF environment, various specifications must be taken into account. The chapter "Building structure and RF topology" in this documentation provides more detailed information on this.

Information transmission with radio signals

An electromagnetic wave of a constant amplitude and frequency does not yet carry any information. To make this possible, the transmitter must change the amplitude or the frequency of the wave continuously according to an agreed method and the carrier signal must modulate the information in this manner. With KNX RF, the modulation type "Frequency key shifting" (FSK = Frequency Shift Keying) is used (Figure 24). Frequency key shifting is a variant of frequency modulation (FM) and suitable for the transmission of digital information. Two time-coded signals of a different frequency are transmitted, in order to inform the receiver of the logical states "0" and "1". Frequency key shifting is impervious to interference. Even major transmission losses in signal amplitude do not have a negative effect on the demodulation of the transmitted information.

For KNX RF, the data rate is 16.384 kBit/s. Manchester encoding is used to apply the "0" and "1" information to the radio signal. This allows very easy synchronisation of the transmitter and receiver.

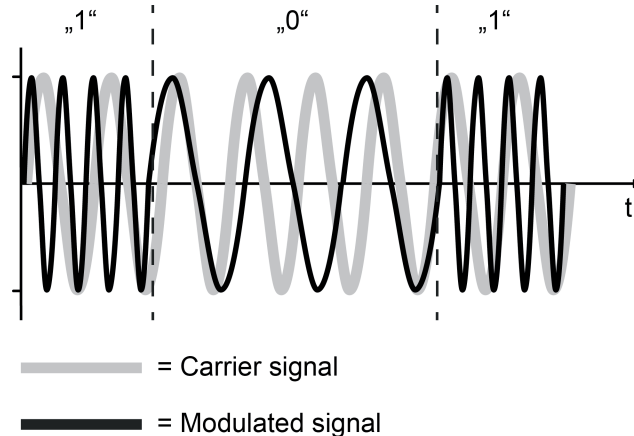

Figure 24: Frequency key shifting as a modulation method (FSK = Frequency Shift Keying)

Radiation and attenuation of radio signals in buildings

Radio waves with a frequency used for KNX RF can penetrate ceilings or walls in a building. Depending on the mass (thickness) and conductivity (metallic component, humidity), this is connected with a greater or lesser energy loss. This loss of transmission energy is also called attenuation (ratio of transmitted and received radio radiation power).

Radio signals are attenuated by various influences on their journey between the transmitter and receiver. The precondition for comprehension between the transmitter and receiver is, of course, that the radio signals of the transmitter still have sufficient energy on reaching the receiver for the receiver to be able to evaluate the signals.

Almost ideal radiation conditions for electromagnetic radio signals exist in the free-field. The term "Free-field" refers to a free area, in which radio waves can radiate out more or less unhindered and interference effects from structures or obstacles have no influence.

If walls and ceilings must be penetrated on the transmission path, then the attenuation - and thus the radio range - is primarily dependent upon the number, type and consistency of the construction materials to be penetrated and on the effective wall and ceiling thicknesses. Part of the incidental radio radiation is reflected on the limit areas and a further part is absorbed. Moist materials, as is found in new buildings or recently renovated rooms (newly-papered or plastered) attenuate electromagnetic radio waves to a greater extent.

Material (dry)	Material thickness	Transmission
Wood, plaster, plasterboard *, glass **	< 30 cm	90...100 %
Brick, chipboard plates	< 30 cm	65...95 %
Reinforced concrete	< 30 cm	10...70 %
Metal grid	< 1 mm	0...10 %
Metal, aluminium cladding	< 1 mm	0 %

*: no metallic stand

** : without metallisation or wire inlay, no leaded glass

Take the attenuation factors of a building into account when selecting the mounting locations of KNX RF devices (hand-held transmitters, pushbutton sensors, media couplers). Take into account too that each KNX RF device is both a transmitter and a receiver on account of the bidirectionality (e.g. hand-held transmitters with or without LED status display and media couplers are transmitters and receivers in the same way).



 Position of transmitters (e.g. hand-held transmitter, pushbutton sensor)

 Position of possible receivers (e.g. media coupler)

 In reception field

 Not located favourably in reception field

 Not in reception field

 Attenuated signal path

Figure 25: Attenuation of the radio signal in buildings through walls and ceilings
 Example 1: "Edge position of the transmitter" (simplified depiction)

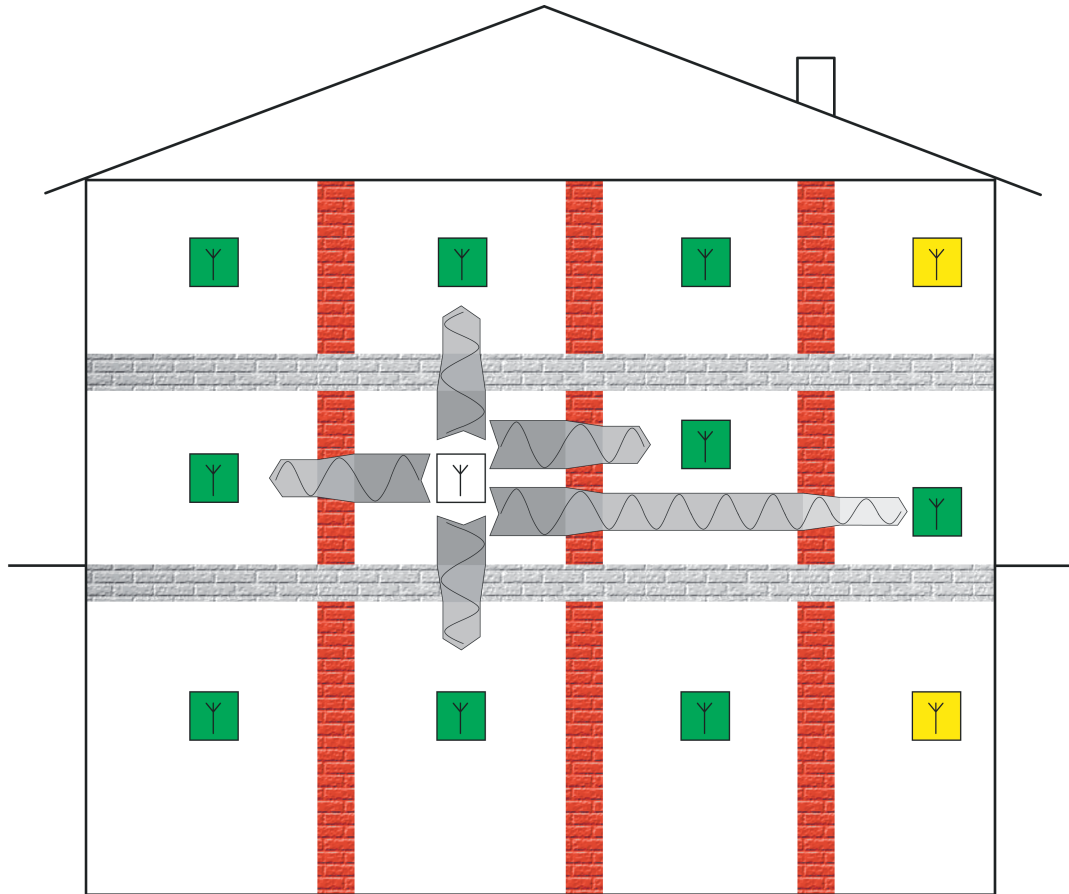

Figure 26: Attenuation of the radio signal in buildings through walls and ceilings
Example 2: "Central position of the transmitter" (simplified depiction)

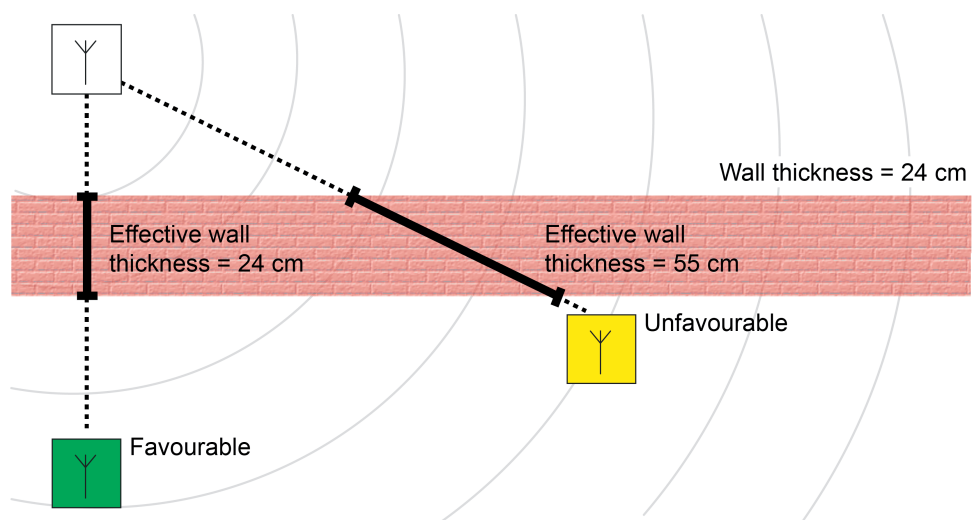

Figure 27: Attenuation through effective wall or ceiling thickness

- i** Care is required when a building is equipped with shielding materials to reduce electromagnetic waves. Flush-mounted boxes with a conductive coating are not usually suitable for radio products. Special shielding plasters and plasterboard protection plates, into which conductive fibres are worked, reduce the permeability of radio waves by up to 95%. The same applies to stands, into which high level of metallic components (e.g. supporting parts, metallised insulation material) are integrated.
- i** Due to the wide range of influences, it is difficult to evaluate radio sections in buildings. Eventually a manufacturer of radio products - also of other systems such as Wi-Fi - cannot make any binding statement on the range of radio transmission in buildings. For this reason, the free-field range is always stated, which refers to an uninterrupted radiation of the radio waves and optimally aligned antennas. Provided that there are no special measures for shielding in buildings, this means that targeted radio transmission should be possible.

Additional attenuation in a building or in a more or less free field (outdoors) is created when the antenna of the transmitter or receiver is mounted at a low ground height. KNX RF radio sensors and actuators should therefore be mounted as far from the ground as possible.

The mounting of a transmitter or receiver in the ground (e.g. in a suitable installation box) should be avoided, particularly outdoors. The radio range would be restricted to such an extent that radio transmission would scarcely be possible.

- i** We recommend installing KNX RF pushbutton sensors at a standard mounting height of 1.05...1.50 m.

Electrically conductive materials cannot be penetrated by electromagnetic waves. Metallic components of buildings, e.g. furniture or steel reinforcement rods in concrete (Figure 28), but also metallic design frames or design parts with metallic coatings thus have a shielding effect. Metallic shieldings can also be used consciously to keep an area free of radio waves.

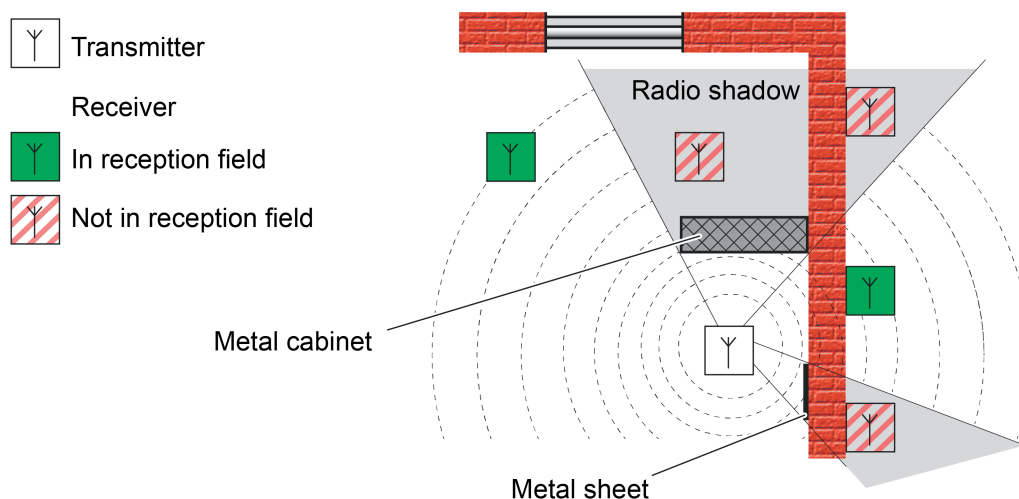

Figure 28: Radio shadow in a building due to metallic parts (idealised)

Radio waves reach the receiver both directly (through the air) and also via diversions (multiple route radiation). Such diversions are created by reflections of the radio waves at boundary layers to other materials, e.g. on the surfaces of walls or ceilings. Radio waves of an identical

source are at the receiver with a differing phase location. In many cases, the reflected radio power is too small to influence the direct path of the radio wave in any significant way. A receiver can then receive the signal of the transmitter without any interference (Figure 29).

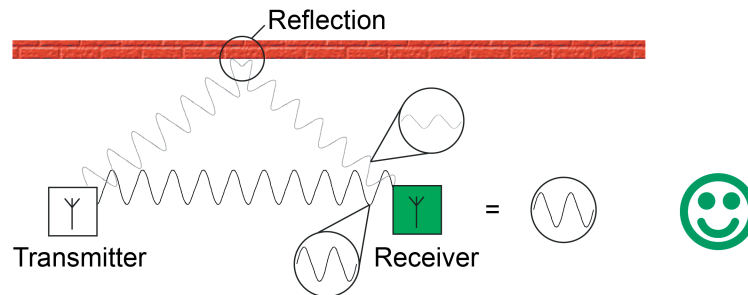

Figure 29: Interference has no effect on the receiver

However, in the worst case, the waves received directly and via reflection are superimposed unfavourably at the target location, creating a signal which receivers can no longer evaluate reliably (Figure 30). Positive and negative superposition of radio waves pointing the same way is also termed interference.

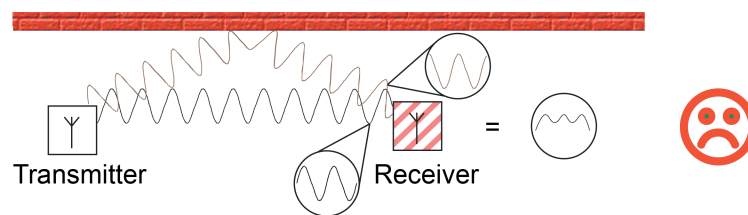

Figure 30: Interference at the receiver prevents reception

Effects from reflections can also be used positively in a building. If possible, RF devices, or their transmission and reception antennas, can be installed horizontally or vertically in the same alignment, as the radio wave also swings in the appropriate direction (polarisation). If antennas are aligned in different ways, then the signal available at the receiver is weakened and thus the maximum radio range is reduced. The weakening of the signal can be of such magnitude that a receiver can no longer receive any output radiated directly from the transmitter. However, in practical terms, reflections may cause a rotation of the polarisation direction, meaning that the reflected signal reaches the receiver in a weakened form and can also be understood there (Figure 31).

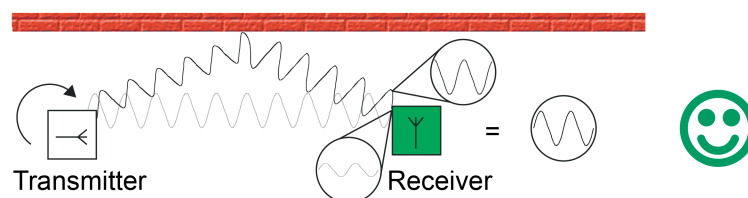

Figure 31: Reflection allows reception through a change of polarisation

In practice, reflection and interference effects can frequently be changed or used beneficially through a slight change in the installation location or the installation environment.

- i** With KNX RF pushbutton sensors, only vertical mounting of the device on walls or objects ensures the alignment of the internal antenna. If all the pushbutton sensors are mounted in the same way, then, in consequence, all their antennas are aligned to one another.

Influence of KNX RF on the human body

For many decades, radio waves have been used intensively for radio and global communication. In particular, the new communication media for wireless telephony (UMTS, LTE, DECT) and network communication (Wi-Fi, Bluetooth) are now being used widely in homes and in industry. However, other electrical devices radiate electromagnetic waves, e.g. microwave ovens.

The use of radio waves is regulated by the state. The assignment of frequency ranges and the specification of limit values ensure that there are no health impacts for people and different radio services do not influence one another. In particular, with regard to the number of electrical applications, wireless computer networks, mobile radio telephones and radio services, it must be established that the radio load of multiple KNX RF installations in parallel remains negligible.

Selecting installation location

If possible, the mounting locations of KNX RF devices must be evaluated during the planning of the electrical installation. Concrete ceilings with metal reinforcements attenuate radio radiation to a greater extent than wooden ceilings. The same applies for mineral plasters or hollow walls on the basis of a metallic stand. Room use should also - if known - be taken into account, because a living room in an existing building offers fewer obstacles to radio radiation than an office with metallic cabinets.

A KNX RF media coupler should ideally be positioned in the centre of an RF installation (domain) to allow low-loss and thus interference-free communication with all the corresponding RF devices. The housing of the media coupler is compact, meaning that it can be installed simply in standard flush-mounted boxes (ideally in cavity walls) or surface-mounted boxes (e.g. in suspended ceiling constructions).

General rules on the mounting of KNX RF devices (transmitters, receivers and media couplers).

- Avoid shadows, reflections, extinguishing of radio signals as far as possible. For this, note the structural conditions (supporting metallic parts, metal reinforcements, metallic wall and ceiling panelling, metal-coated panes of glass / heat protection glazing).
- Do not mount the transmitter and receiver near the earth or ground.
- Align unmoveable devices to each other as identically as possible, so that the internal transmission and reception antennas are polarised identically.
- Position the antenna of the media couplers so that they are as straight (stretched out, unkinked) or as circular as possible in the box.
- Ensure a distance to larger metallic surfaces, e.g. doors, frames, aluminium shutters, ceiling panelling, distribution cabinets, insulating films, ventilation grilles, is maintained.
- Ensure the penetrations of walls and ceilings are as short as possible.
- Do not place KNX RF devices in small metallic distributors or boxes.
- Maintain a distance to electromagnetic interference, e.g. electronic ballasts, motors, Tronic transformers, microwaves.
- Maintain a distance to other radio sources, e.g. wireless telephones, radio headphones, WiFi routers.

- i** During mounting, particularly of media couplers, ensure that the devices are accessible after this.

5.1.3 Building structure and RF topology

Introduction

KNX RF1.R makes a shared communication channel available for all devices. Radio communication, which only has one transmission and reception channel available, can be subject to interference by third-party radio services in the same frequency range or by the same system. Even a second KNX RF line in the same or a neighbouring KNX installation can invoke communication faults in a building. The transmission methods used for KNX RF (LBT: Listen Before Talk) are not always sufficient for ensuring interference-free communication in every case.

A communication fault can occur, for example, when two or more RF environments exist in a building, which do not have an identical radio range and only overlap. For example, in installations with two or more media couplers where the couplers are at some distance from one another. If the media couplers are out of the other's range, then they cannot detect whether another media coupler is already transmitting a group telegram. However, the KNX subscribers in the various RF lines can be located in such a way that they are in the overlap areas of the RF domains of the couplers. In consequence, it is possible that subscribers will receive the colliding telegrams of multiple media couplers. On RF devices, a symptom of such a fault could be that individual telegrams are lost (e.g. control command is not received, there is no status feedback).

- i** Usually, the random delay in transmitting RF telegrams ensures that media couplers on the same TP backbone or main line are unable to simultaneously transmit telegrams to their RF lines during forwarding. Gira media couplers guarantee this function. However, media couplers of other manufacturers can be used, which forward a group telegram received from the TP side to the appropriate RF lines almost simultaneously due to their filter properties, after the couplers have determined that the radio channel is free. In these cases, telegram collisions occur very frequently during the operation of a KNX RF system. For this reason, we recommend you always use Gira media couplers.
- i** Simultaneous transmission of radio telegrams when multiple Gira pushbutton sensors or hand-held actuators are actuated is not possible, as these devices always keep to a varying random time when transmitting. A telegram collision is only excluded by device operation in normal operation, even if a button-press takes place almost simultaneously on multiple control panels.
An absolutely simultaneous reaction to system telegrams (broadcast) or group read telegrams (Read flag set on more than just one subscriber) is not possible on Gira KNX RF devices.

With more than two RF lines in a KNX installation, communication problems can become so great that secure data transmission, and thus a fault-free function of the KNX system, is not possible, either temporarily or continually. For this reason, key conditions are to be checked already during building planning and the planning of the KNX topology and the requirements for the installation and configuration of the KNX RF devices are to be taken into account. This chapter describes in detail all the key aspects to do with the building structure and the ETS integration of KNX RF devices.

Building structure

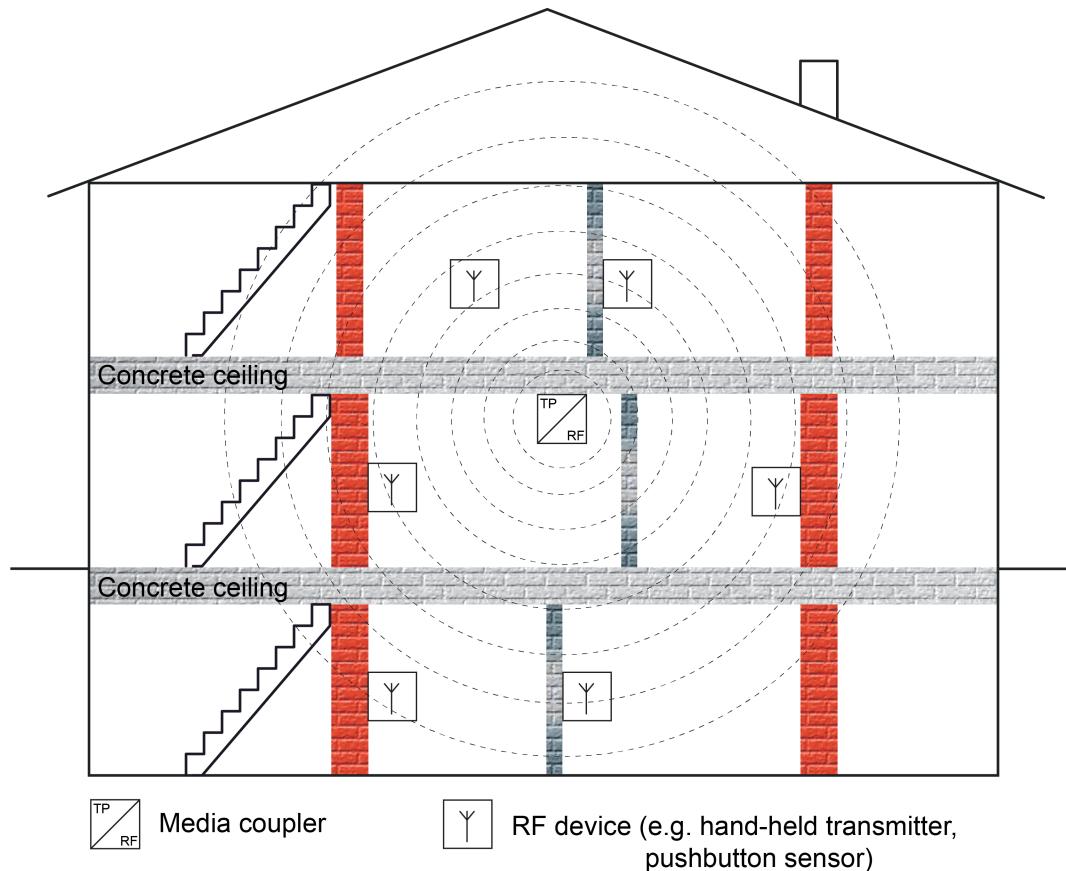

Figure 32: Building with a KNX RF line (example)

The frequency band at 868 MHz as used by the KNX RF has good signal radiation in buildings, since the attenuation due to walls, concrete reinforcements and metal parts close to the transmitter keeps within reasonable limits. This is positive when - for example in a detached house - one storey or even multiple storeys are to be covered with one and the same RF line. The media coupler should then be positioned as close to the centre of the building as possible (Figure 32).

The good signal radiation may be a disadvantage in real estate if the RF lines influence each other physically, are only partially within their radio ranges due to a small spatial distance or through insufficiently large attenuation due to wooden ceilings or thin walls (Figure 33). Here, it is wise not to create two or more RF lines (each with their own media couplers), but to use RF repeaters which increase the radio range of one RF line (Figure 34). Here too, the media coupler should be positioned as close to the centre of the building as possible. Repeaters should ideally be located on the edges of the building although still within the range of the media coupler and also within the ranges of other repeaters.

- i** Gira media couplers can only work as media couplers, as media couplers and repeaters or only as repeaters. The operating mode is defined by the parameter setting and the physical address of the media coupler. The functional description of the media coupler describes this in more detail. Combined operation of the media coupler and repeater function is helpful if, within a radio domain, all the RF subscribers are within radio range of the media coupler but are not however in the radio ranges of other RF subscribers. Here, the repeater integrated in the central media coupler ensures that telegrams from RF subscribers also actually reach all the other RF subscribers of the radio domain.

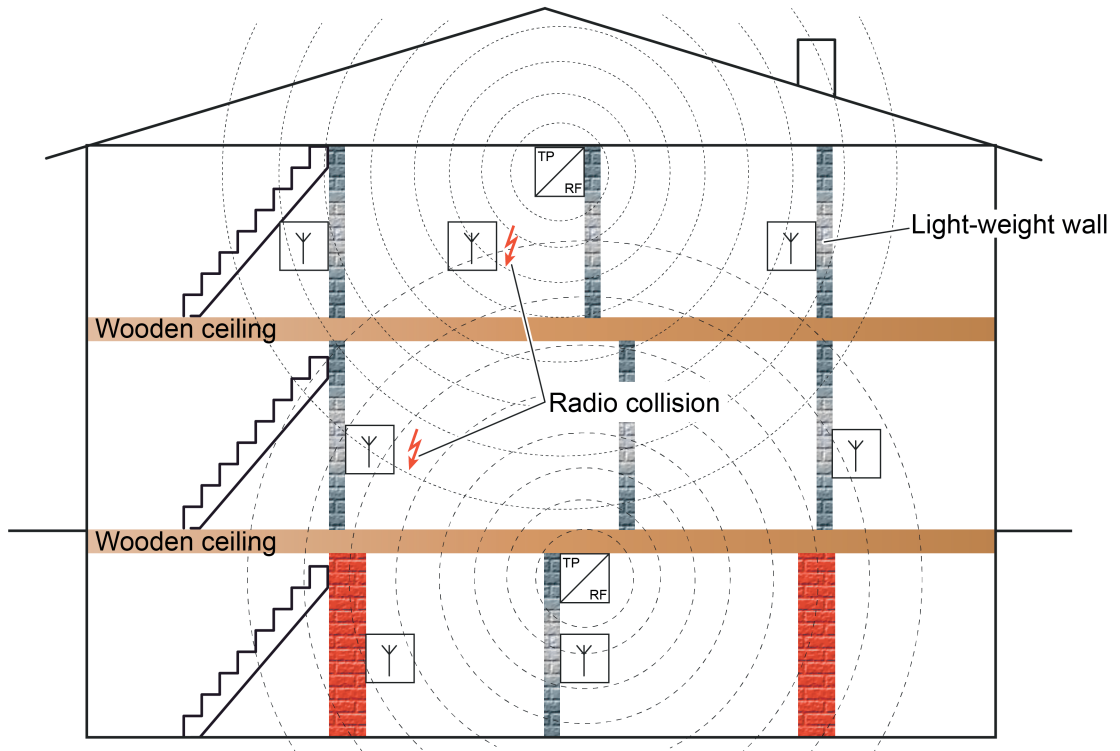

Figure 33: Building structure with two KNX RF lines, disadvantageous influence (example)

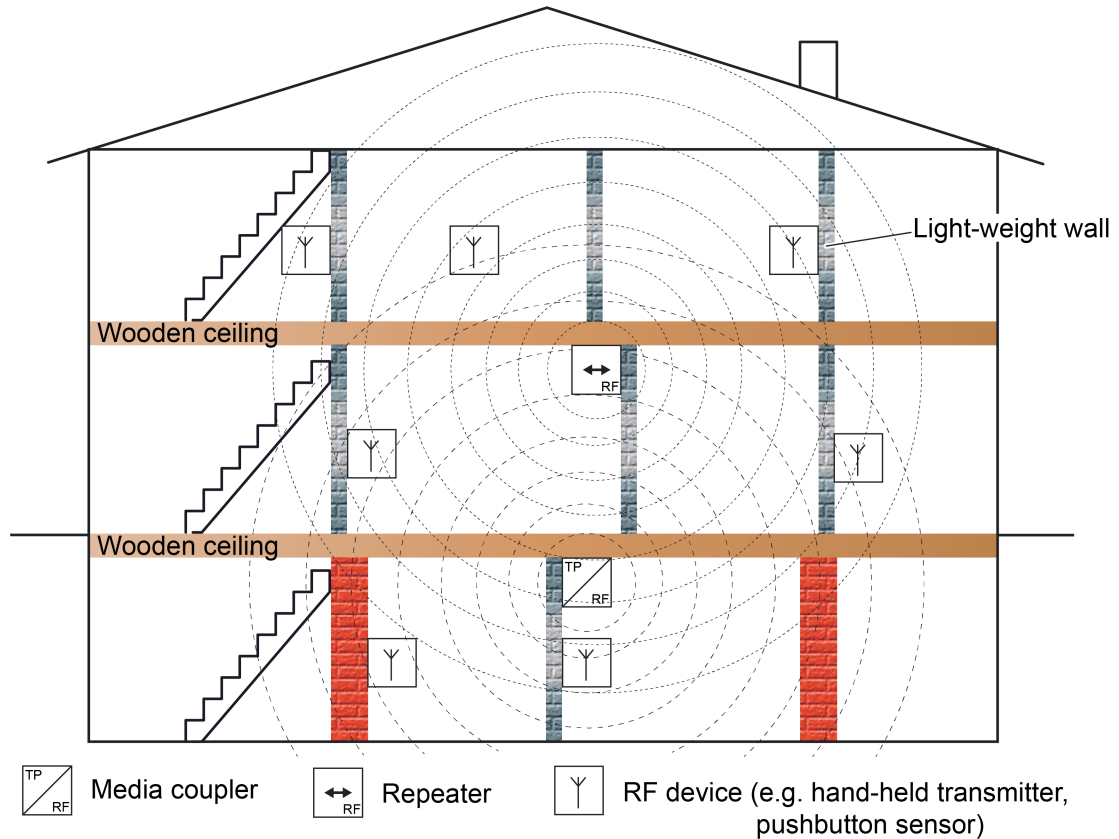

Figure 34: Building structure with one KNX RF line and repeater (example)

The use of more than one RF line is wise in large or extensive buildings or building sections, as the RF lines can then be separated sufficiently from one another, meaning that they no longer have a negative influence on one another. Different RF lines, each with their own media couplers, can also be used in smaller buildings (e.g. detached houses) or in apartment buildings, if the building structure and the consistency of the ceilings and walls shields the individual RF areas sufficiently (Figure 35). Underfloor heating can, for example, provide sufficient attenuation of the radio signals in the vertical direction. In the long-distance range, solid, supporting walls can make a positive contribution to achieving sufficiently large attenuation of the radio signals.

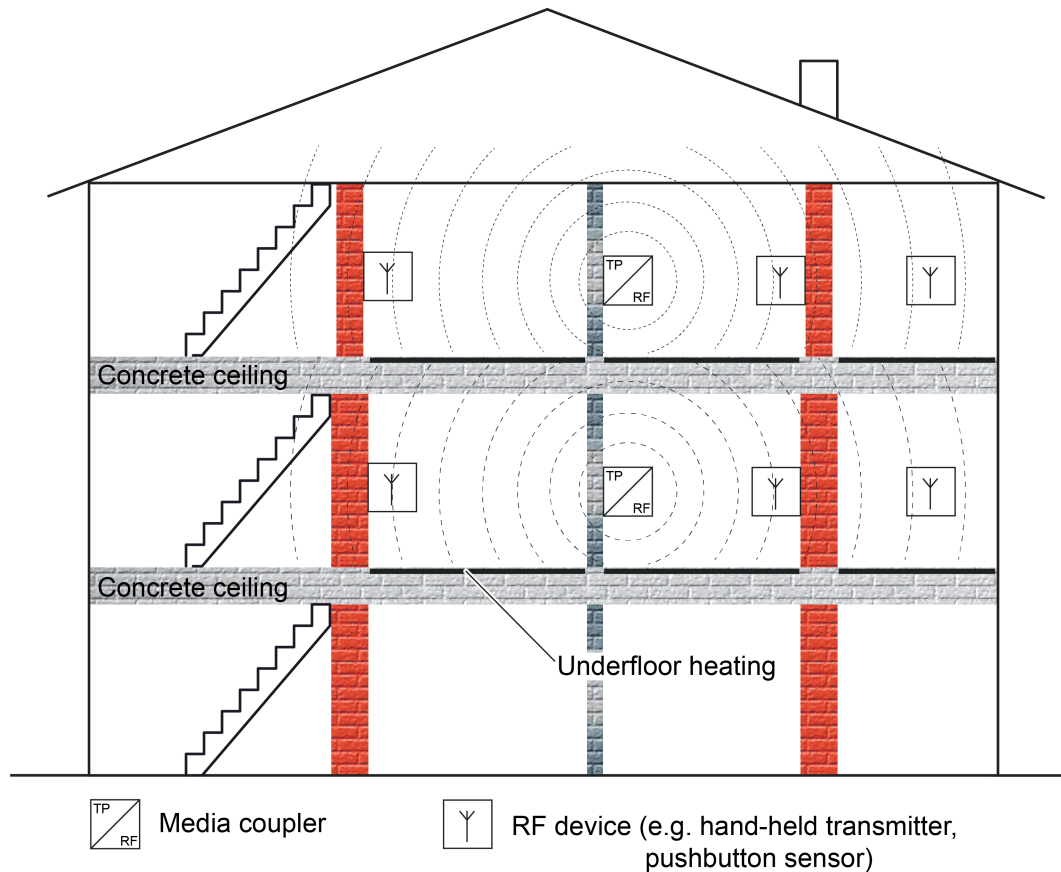

Figure 35: Building structure with two KNX RF lines, which do not influence each other negatively due to the building consistency (example)

A media coupler can also be used outdoors (if necessary as a repeater) in a suitable installation socket (ideally plastic AP WG), in order to make the KNX RF signals available directly between buildings or to amplify them. This means that KNX RF devices can be used outdoors - if the consistency of the buildings allows it - or in separate buildings (e.g. shed) (Figure 36).

Ideally, a repeater can also be used for signal amplification and the elimination of radio shadow through metallic furnishings or substances in the interior of the building.

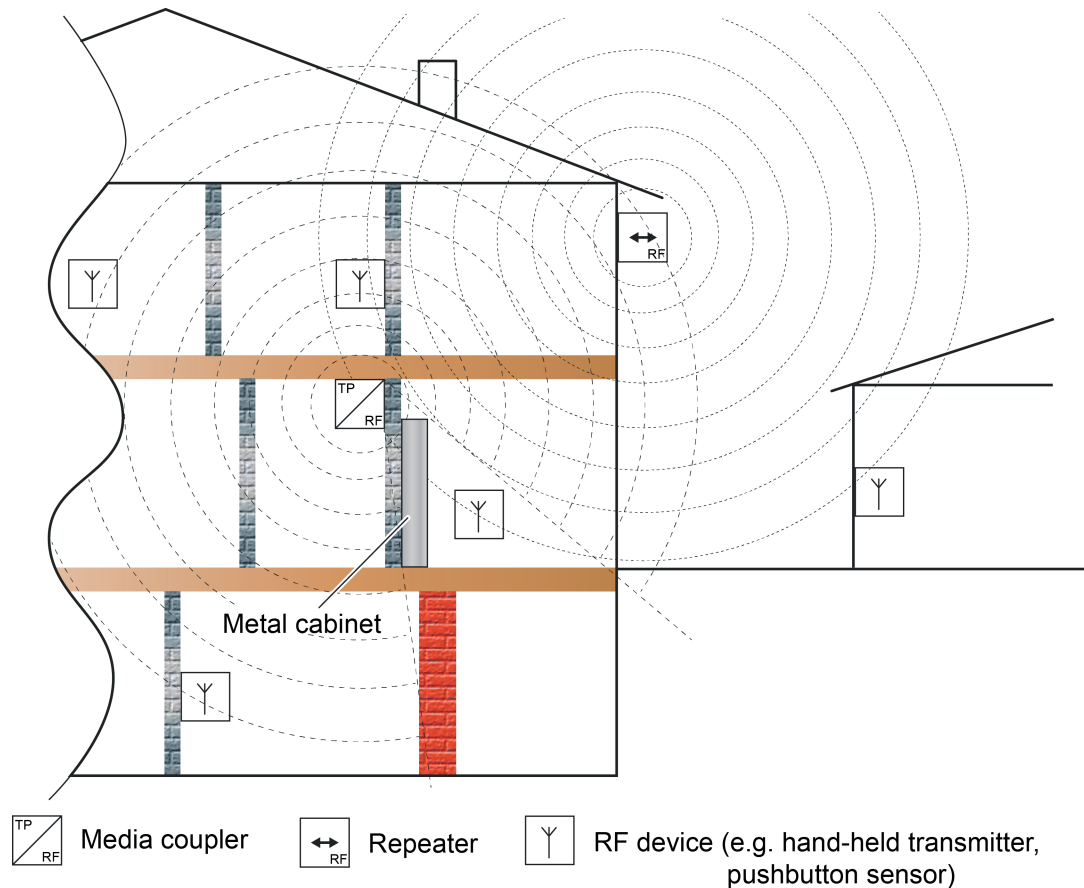

Figure 36: Use of a media coupler as a repeater for signal amplification and elimination of radio shadow for indoor and outdoor applications

Domain address for KNX RF

The radio range of KNX RF devices cannot be determined exactly in spatial terms. KNX RF telegrams cannot be limited to one specific KNX installation. Radio telegrams pass through the borders of buildings and plots of land and can be received by devices installed in neighbouring KNX systems. For this reason, it is important that different KNX RF installations are delimited topologically and thus logically from one another. The domain address helps here.

In accordance with the topology defined in the ETS project, devices assigned to the RF lines also always receive a domain address, in addition to the physical addresses. Only devices with the same domain address can communicate with each other within an RF environment. As a result, a media coupler must always have the same domain address as all the devices in its subordinate RF line.

- i** The domain address is defined in the ETS for each RF line or for each RF area. If an area is set to the media types "RF", then all the subordinate RF lines automatically receive the same domain address in the ETS.
The ETS programs the domain address automatically into the RF devices when the physical address is programmed.
- i** A domain address is 6 bytes long and is entered in the ETS in hexadecimals or generated automatically. After the first 2 bytes, the input notation requires a colon (when read from the left). For example, a domain address could look like this: "0011:22334455" or "00FA:4F5B3122".

- i** KNX RF systems always influence each other physically when they are spatially located in each other's radio range and two or more transmitters transmit more or less simultaneously, which is perfectly possible. Radio telegrams can be superimposed. In this case, the receivers can no longer evaluate the affected radio telegrams. For more information on the transmission property and superposition of RF telegrams, refer to the chapter "Basic physical principles" in this documentation (see page 47).

RF topology and ETS

Media couplers are the link between a specific KNX RF environment and a wired KNX TwistedPair installation. With regard to the routing property of telegrams, media couplers function like standard TP backbone/line couplers. This means that RF devices can communicate with TP or IP devices and vice-versa.

Media couplers possess filter settings and filter tables. The physical address defines whether a media coupler is a line coupler or a backbone coupler.

Optionally, the Gira media coupler can additionally or alternatively work as an RF repeater. A repeater repeats the radio telegrams received in its RF line by retransmitting them immediately. This allows an extension of the range of a KNX RF installation, meaning that it is possible to position RF devices as required in a building, even in the case of difficult transmission and reception conditions.

- i** The Gira media coupler is a device which allows the media type "RF" on the lower-level line and the media type "TP" on the higher-level line.

As with all other KNX components with S-Mode commissioning, KNX RF devices are configured and commissioned using the ETS. In consequence, RF devices also possess a physical address, parameters and communication objects. In addition, a unique domain address is assigned to each RF line in the ETS. Only devices with the same domain address can communicate with each other.

- i** Addressing, configuration and diagnostics of KNX RF devices are only implemented in the ETS of Version 5 or higher. Older versions of the ETS do not possess manufacturer-independent KNX RF support.

A media coupler can either be inserted in the KNX topology as a backbone coupler or, alternatively, as a line coupler. With KNX RF, there is generally no physical limitation of the number of possible bus subscribers as in a TP line (e.g. 64). With KNX RF, the number of subscribers is only limited by the physical addresses assigned in the ETS.

- Media coupler as line coupler:

A KNX RF line can contain up to 256 devices (including media coupler) (Figure 37). The media coupler is connected to the main TP line of an area. Additional TP lines can be set up using additional TP line couplers.

- i** There may only ever be one media coupler in an RF line.

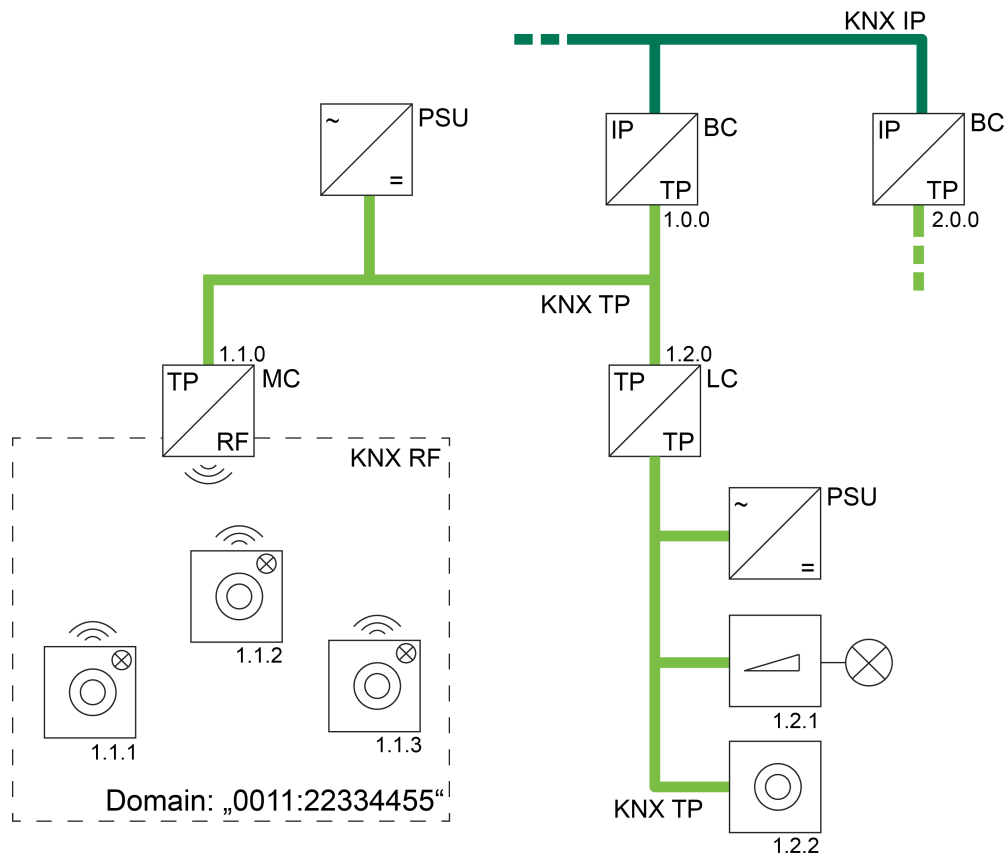

Figure 37: Example of a possible KNX topology with RF, TP and IP lines
Media coupler as line coupler

MC Media coupler as line coupler (TP, RF)

LC Line coupler (TP)

BC Backbone coupler (as IP router / TP, IP)

PSU Power supply (TP)

- Media coupler as backbone coupler:
If a media coupler is used as a backbone coupler, then a total of up to 4,081 RF devices (including media couplers) can be integrated into the appropriate area. The RF devices must then divide themselves up on the backbone line and on up to 15 additional subordinate RF lines (Figure 38). In the ETS, a maximum of 255 subscribers may exist for each area or line.
If the media coupler is a backbone coupler, then the backbone must possess the media type "TP". A KNX IP environment cannot then be implemented (the ETS prevents such a topology)!
 - i** Even in an RF area, there may only be one media coupler (subordinate RF lines do not possess their own media coupler).
 - i** Subordinate RF lines of an RF area always have the same domain address as the area itself.

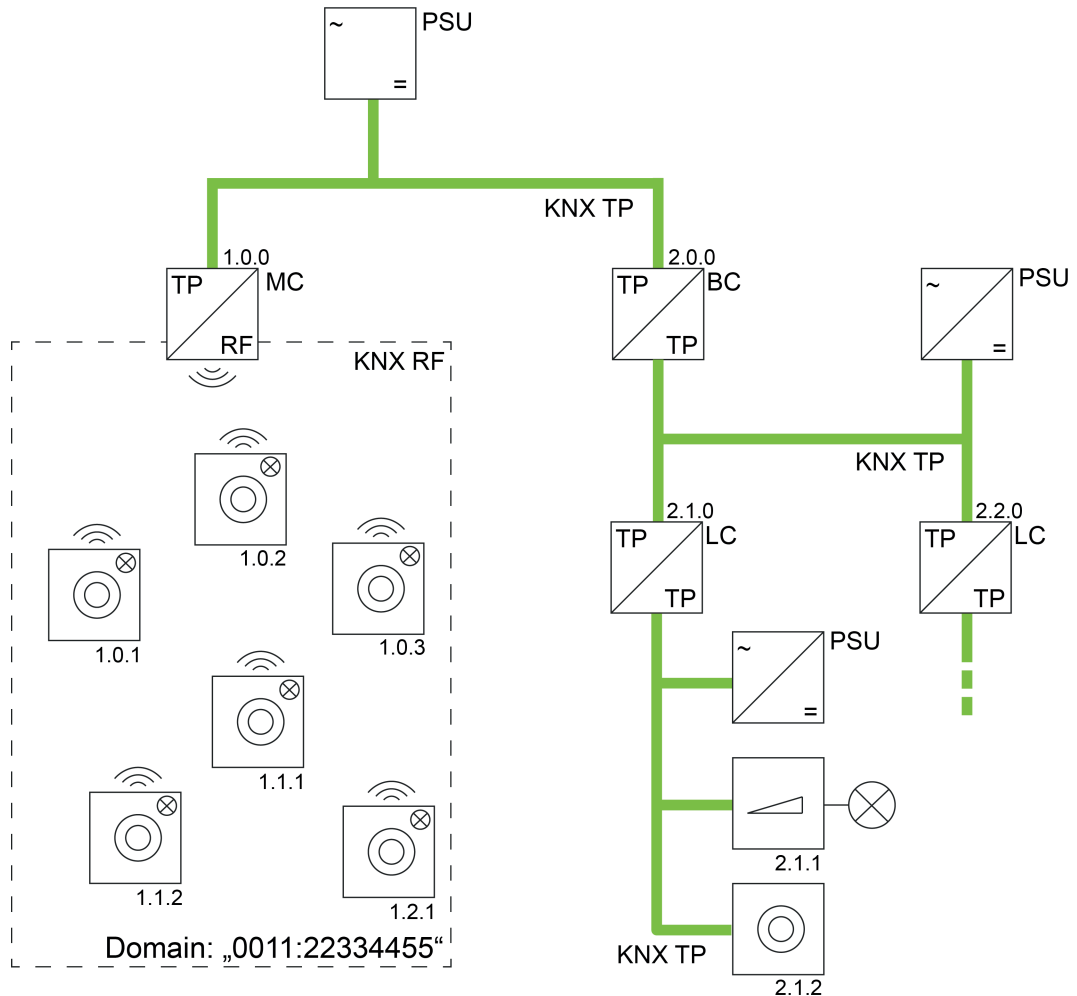

Figure 38: Example of a possible KNX topology with RF and TP lines
Media coupler as backbone coupler

MC Media coupler as backbone coupler (TP, RF)

LC Line coupler (TP)

BC Backbone coupler (TP)

PSU Power supply (TP)

Devices in different RF domains must be topologically divided into two different lines or backbones, each with their own domain addresses. These different areas or lines must also contain their own media couplers for the devices to be able to communicate with one another, irrespective of the line. The logical connection between two or more KNX RF environments is thus always made via media couplers and higher-level TP/IP lines (Figure 39).

KNX RF USB data interfaces, as used in the ETS, are also assigned to a domain address. In consequence, only RF devices of the same domain can be commissioned directly by radio telegram. Only group telegrams and physically addressed telegrams of the appropriate RF domain are recorded in the group monitor of the ETS (exception: System broadcast telegrams, see "Expert knowledge" further down). If other RF devices of another domain are to be contacted with an RF data interface, then communication via media couplers is necessary. If the KNX topology is set up correctly, then such communication takes place automatically via the KNX routing (precondition: media and backbone/line couplers forward the telegrams according to their filter property).

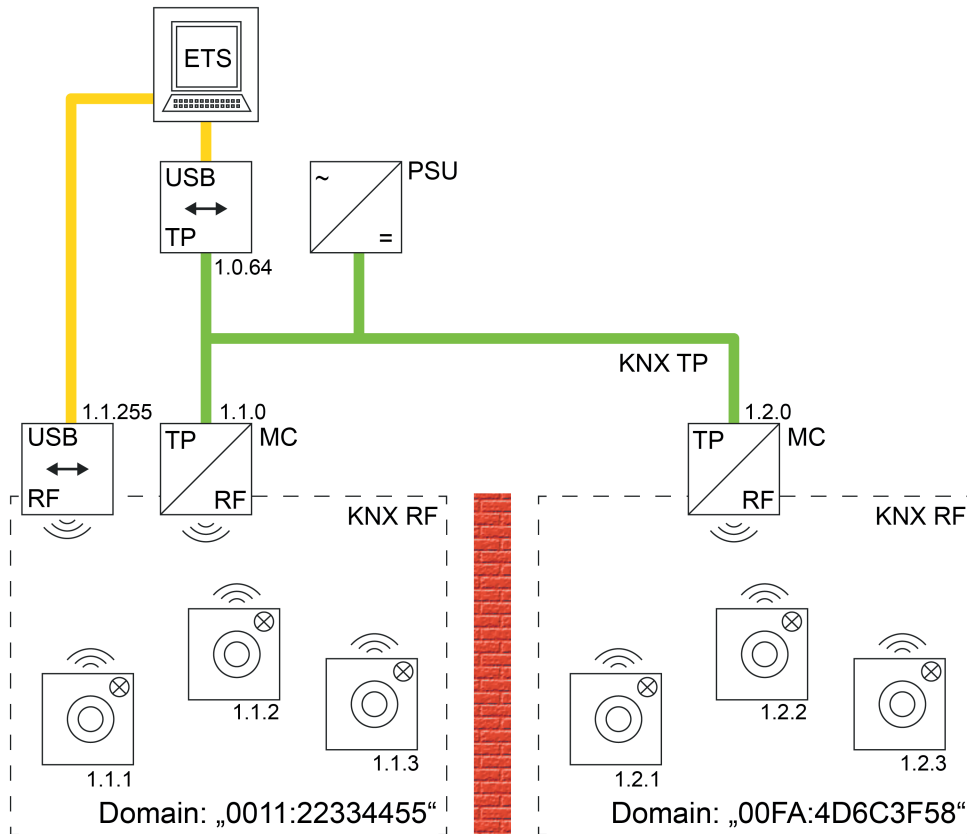

Figure 39: Example of a possible KNX topology with two RF lines and coupling via a TP main line (example)

- i** In general, multiple media couplers can be used in various lines and areas of a KNX topology. The ETS permits such a configuration. However, media couplers in a shared KNX system can influence each other unfavourably. In particular, during the commissioning of various bus devices using the ETS, radio telegrams may be superimposed, meaning that radio communication is poor or even impossible. Suitable precautions can be taken to avoid such a situation (spatial separation of the RF environments, logical filtering of specific telegrams).
- i** Media couplers cannot be used to network two or more KNX installations via RF (no proxy function)!
- i** RF areas or lines of a joint KNX installation or of directly adjacent KNX installations in radio range may never have an identical domain address! The ETS offers a function for random assignment of a domain address for RF lines, in order to avoid this improper situation. When the random function is used, the probability of multiple assignment of an identical address is more or less non-existent. A domain address automatically generated by the ETS is characterised by the hexadecimal characters "00FA..." (e.g. "00FA:4D6C3F58").

KNX RF systems are addressed, configured and diagnosed in the normal fashion via the ETS data interfaces.

- Use of a KNX RF USB data interface (Figure 40):
All the devices of an RF line or an RF area can be programmed and diagnosed directly via the KNX RF USB data interface. It is important that the KNX RF data interface has a valid physical address of the RF line or the RF area and is configured with the same domain address.
In addition, all the other devices of the KNX installation can be programmed using a media coupler with an identical domain address. A wired data interface is not essential for this.
If necessary, the KNX RF USB data interface can also be used in the group or bus monitor of the ETS5, in order to record RF telegrams of the corresponding RF domain.
- i** In the group monitor, a KNX RF USB data interface only displays group-addressed telegrams of the same RF domain. In addition, the interface displays physically addressed telegrams, provided that it is also used as the ETS programming interface. In the bus monitor, a KNX RF USB data interface only displays group-addressed telegrams.

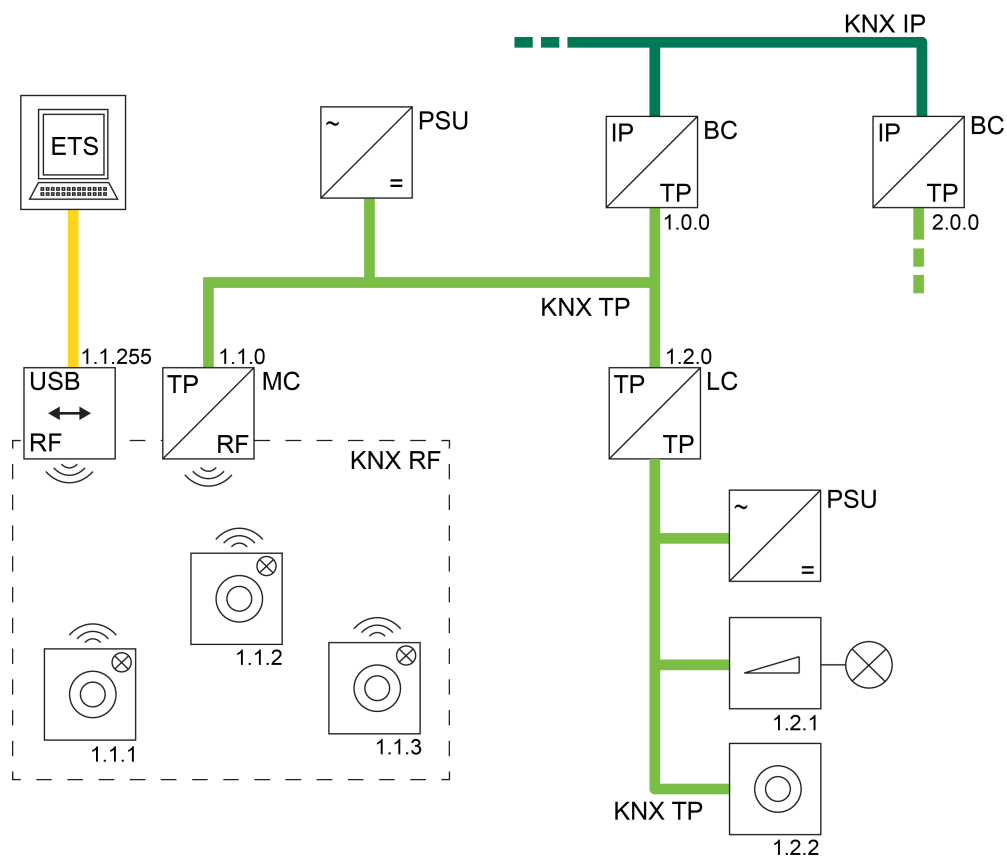

Figure 40: Example of a possible KNX topology with a KNX RF USB data interface

- Use of a KNX TP USB data interface (Figure 41):
RF devices can only be commissioned and diagnosed using a KNX TP USB data interface when a media coupler is also available. It is irrelevant in which line the KNX TP USB data interface is located so long as the topology of the KNX system is structured according to regulations (all the couplers and the data interface itself must have correct physical addresses and also guarantee telegram forwarding).

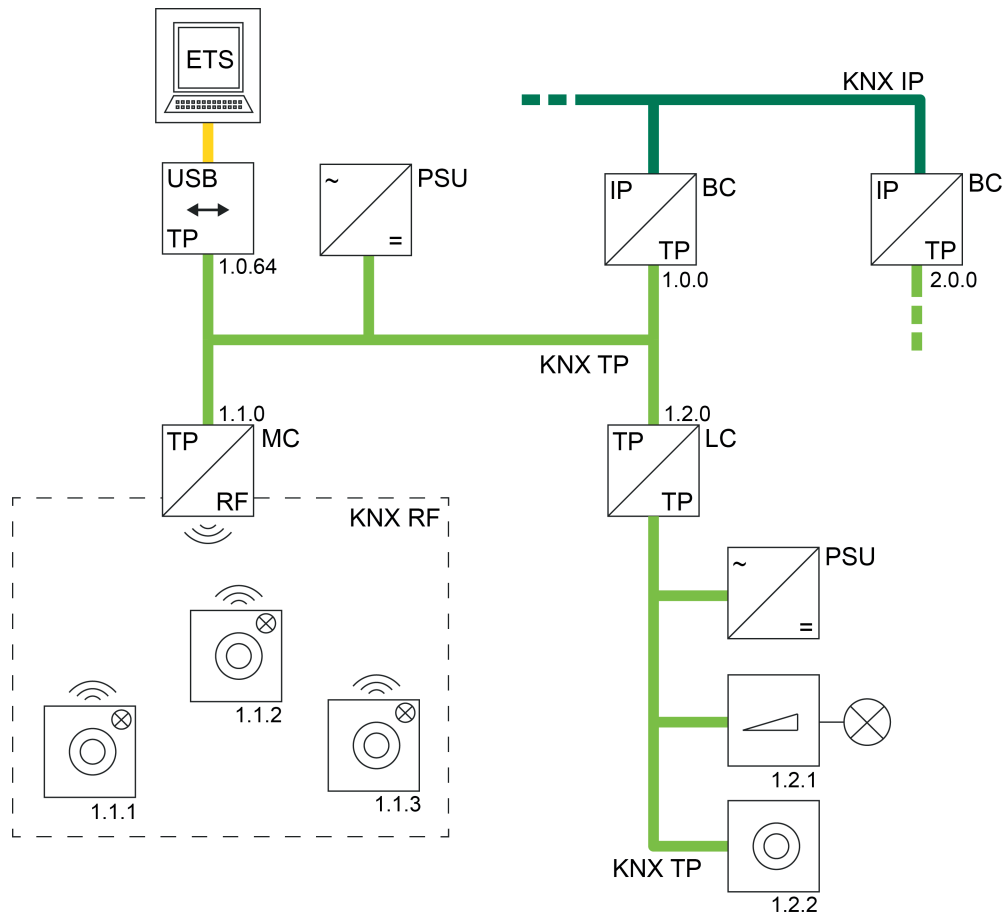

Figure 41: Example of a possible KNX topology with a KNX TP USB data interface

- Use of a KNX IP data interface (KNX/net IP) (Figure 42):
An IP connection of the ETS can also be used to commission or diagnose devices in a KNX RF environment. Here too, it is essential that a media coupler is available, which first connects the appropriate RF line in the correct manner with a TP line (main line of a TP area) and then with the IP environment (IP backbone) via a suitable IP router or an IP interface.
If the media coupler is a backbone coupler, then the backbone must possess the media type "TP". A KNX IP environment cannot then be implemented (the ETS prevents such a topology)!

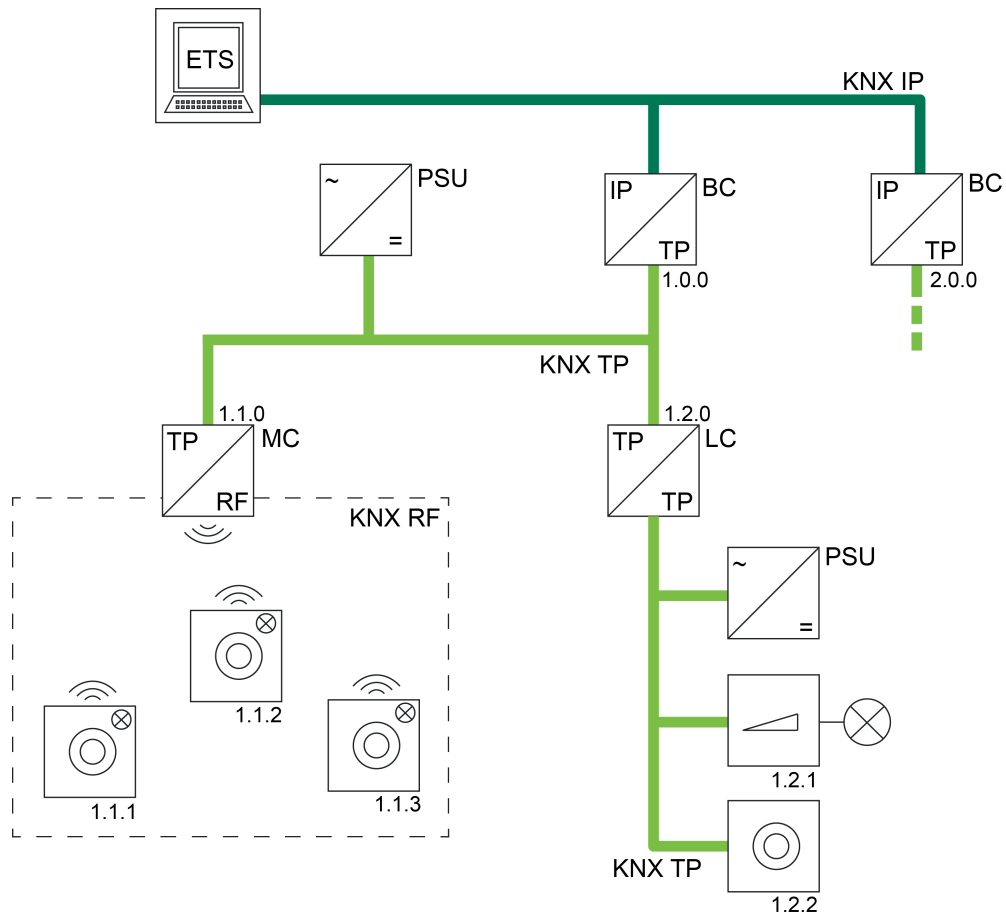

Figure 42: Example of a possible KNX topology with one KNX IP connection of the ETS (KNX/net IP)

RF addressing types (expert knowledge)

As with all KNX media, the payload data is also transmitted on the KNX RF using group telegrams (Multicast). A group telegram (e.g. to switch on the light) can be received from multiple bus subscribers simultaneously, provided that the communication objects of the devices are linked with identical group addresses. Besides the actual group address (2 bytes-long), the domain address (6 bytes-long) is also transmitted in an RF group telegram in accordance with "KNX RF 1.R S-Mode". This means that the recipients of the group telegrams can immediately detect whether they are addressed by the group address, are located in the same RF domain and thus whether they have to react to the group telegram. A media coupler inserts the required domain address into the group telegrams automatically, provided that they were received on the TP side and were transmitted to the RF environment in accordance with the filter setting. In the same way, a media coupler removes the domain supplement when a group telegram is received on the RF side and transmitted to the TP side.

A special type of group telegrams are broadcast telegrams (address 0/0/0). Broadcast telegrams always address all the bus subscribers in an RF environment or in the entire KNX system simultaneously. Such telegrams are used, for example, by the ETS, in order to program physical addresses or domain addresses or to read out which bus devices are in programming mode. Only in RF environments is a distinction made between simple broadcast telegrams and system broadcast telegrams. Only the latter are domain-independent and generated by media couplers as required, if the ETS, for example, has to program or diagnose RF devices via media couplers (TP -> RF). The ETS controls the available media couplers as necessary, so that the

conversion of TP broadcast to RF system broadcast telegrams takes place in a targeted manner and these system telegrams are forwarded.

In the same way, a media coupler converts system broadcast telegrams to normal broadcast telegrams on the TP side. Here too, the ETS automatically controls the function of the routing of such system telegrams in media couplers as required.

The ETS can generate direct system broadcast telegrams when it communicates via an RF USB data interface.

Besides broadcast telegrams, the ETS also uses physically-addressed telegrams in the RF system to program RF devices (Unicast).

- i Group telegrams, broadcast telegrams and physically addressed telegrams can be filtered independently of each other in the media coupler as required or can even be disabled completely. This allows RF lines to be decoupled logically from the rest of the KNX system, according to requirements.

6 Index

B

Battery display.....	22
Building structure.....	55

C

commissioning.....	13
communication fault.....	54
communication objects.....	14

D

delivery state.....	35
Device components.....	6
Dimming.....	26
domain address.....	7,13

E

Electromagnetic wave.....	47
ETS	13
ETS search paths.....	11

F

frequency use.....	43
--------------------	----

I

Information transmission.....	47
installation location.....	53
interference.....	52

L

Load the physical address.....	7
--------------------------------	---

M

modulation type.....	47
multiple route radiation.....	51-52

P

product database.....	13
-----------------------	----

R

reflection.....	52
RF addressing types.....	66
RF topology.....	60

S

Scene extension.....	32
Switching.....	23

T

transmission error.....	21
-------------------------	----

V

Value transmitter 1 byte.....	30
Venetian blind.....	28

Gira
Giersiepen GmbH & Co. KG
Elektro-Installations-
Systeme

Industriegebiet Mermbach
Dahlienstraße
42477 Radevormwald

Postfach 12 20
42461 Radevormwald

Deutschland

Tel +49(0)21 95 - 602-0
Fax +49(0)21 95 - 602-191

www.gira.de
info@gira.de