

Room temperature controller clock with cooling function
2370 ..

GIRA

Table of contents

Normal view in the display	3
Basic operation of the room temperature controller	3
The individual displays and buttons	3
Device description	4
Starting up the room temperature controller.....	4
Prolonging the heating phase (party function)	5
Terminating the party function	5
Changing over to the lowering temperature (economy button)	5
Switching for brief periods to the lowering temperature	5
Permanently switching over to lowering temperature.....	5
Deactivating the lowering temperature	5
Setting the individual temperature	6
Settings in the program menu.....	6
Starting the program menu	6
Setting the date and time – Uhr menu item	7
Modifying the temperature steps – tEMP menu item	8
Modifying the time program – ProG menu item.....	9
Modifying the switching time.....	9
Deleting a switching time.....	10
Aborting the settings at the time program	11
Setting the holiday program – UrLb menu item	11
Setting the holiday period.....	11
Activating/deactivating the anti-freeze function – FrSt menu item ..	12
Selecting the operating mode – ModE menu item	13
Locking buttons.....	13
Cleaning the room temperature controller	13
Warranty.....	14

Normal view in the display

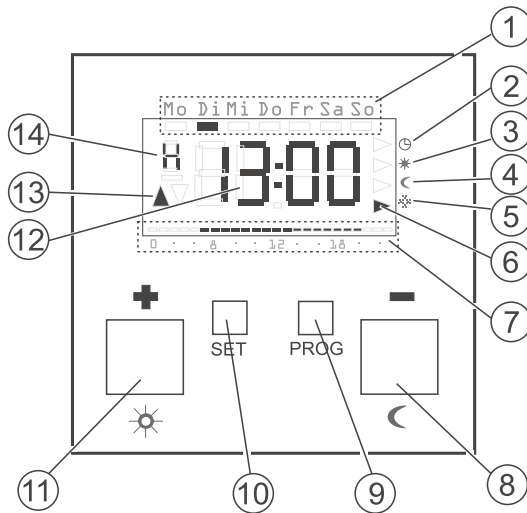

Basic operation of the room temperature controller





Use + and - to set values such as the time or the temperature.

Confirm the set values with S.

If you do not press the S button after carrying out a setting, the display changes automatically back to normal display 5 s after last pressing a button. Changes to the respective values are not accepted in this case.

The P button can be used at any time to return to the normal time program.

The individual displays and buttons

- ① The current weekday is displayed here.
- ② Symbol for the "Time program" operating mode.
- ③ Symbol for the "Comfort temperature" operating mode.
- ④ Symbol for the "Lowering temperature" operating mode.
- ⑤ Symbol for the "Anti-freeze temperature" operating mode.
- ⑥ The current operating mode is indicated here by means of triangles.
- ⑦ The ranges set for the comfort temperature in the time program are displayed here.
- ⑧ - or  button, also called the economy button.
- ⑨ P button.
- ⑩ S button.
- ⑪ + or  button, also called the party button.
- ⑫ The time is displayed here.
You can have this display changed to the temperature display for example by the installer.
- ⑬ This indicates whether heating () or cooling () is being implemented.
- ⑭ Further information on the settings being carried out is displayed here: e.g. H if you set the time.

Device description

Electronic room temperature controller with integrated time delay switch for temperature-based single-room control. Heating units can be controlled directly via the switched output for example.

Within one hour of continuous heating, the room temperature controller automatically interrupts the heating process for 5 min (the heater is switched off).

Temperature measurement can be implemented optionally via the integrated detector or an optional external detector.

The room temperature controller functions in a similar way to a time clock. A heating program defines at which times automatic switching between the different room temperatures is carried out. This enables the setting of a reduced temperature at night or at times when a lower temperature is sufficient, and to operate the heating system during the day with the normally desired room temperature.

The room temperature controller can regulate your heating system to three settable temperatures according to settable times:

- The **comfort temperature** is usually used for the daytime, or more precisely for the periods when you are present.
- The **lowering temperature** is usually used for the night. This is also called economy temperature and can only be selected in heating mode.
- The **anti-freeze temperature** is usually used for longer periods of absence (e.g. for holidays). The temperature is just high enough to protect the heating system against freezing.

Cooling function

The room temperature controller features a switch-over input (terminal K) for control via a heat pump. If the heat pump switches to cooling mode in summer, switching of the room temperature controller from heating to cooling mode is automatic. In 'cooling' operating mode, the running time program is interrupted and the cooling temperature is the setpoint.

Starting up the room temperature controller

When the room temperature controller is switched on for the first time as well as after long deactivation periods, e.g. after a power failure for longer than 4 hours, the room temperature controller jumps automatically to the time input - the current data **must** be entered here. (you can edit these data later --> for further information please refer to „Setting the date and time – Uhr menu item“ auf Seite 7).

✓ The hour display flashes

1. Set the hour with + or -.

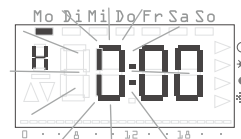

Time format

You can have the time displayed in international 24 hour format (0H...23H) or in the English-speaking a.m. (12AM...11AM) and p.m. format (12PM...11PM). When you set the clock, the display **begins** with the 24-hour format, followed by the AM/PM format. Depending on the hour format which you confirm with **S**, the time is displayed in future in 24-hour format or in AM/PM format.

2. Confirm with **S**.

✓ The hour is set and the minute display flashes.

3. Enter all further data in the same manner:

- Minutes
- Calendar year
- Month
- Day

4. Confirm each time with **S**.

✓ After the last confirmation with **S** the normal display is shown.

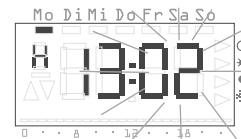

Prolonging the heating phase (party function)

If required, you can activate or extend the comfort temperature with **⏸** – the so-called party function.

This extension applies only once. After the extension has expired, the set time program is executed as usual.



Note!

You can extend or activate the heating phase by up to four hours. In addition, you can also repeat this extension as often as desired.

1. Press **⏸**.

- ✓ The comfort temperature is extended by 1 hour whenever the button is pressed - counting is started from the time the button is pressed.

The period for which the party function is set flashes at the lower display margin.

- ✓ The display returns to the normal display when no button is pressed for a few seconds.

The period for which the party function is set flashes at the lower display margin.



Terminating the party function

1. Press **P** to terminate the party function.
- ✓ The room temperature controller returns to the normal time program.

Changing over to the lowering temperature (economy button)

⏸ enables switching to the lowering temperature either for a short period or permanently. This function is only available in the Heating operating mode.

Switching for brief periods to the lowering temperature

1. Press **⏸**.

- ✓ The room temperature controller switches over to the lowering temperature. The Lowering temperature mode is displayed.

This changeover is retained until the next switching time in the time program.

P reactivates the time program.



Permanently switching over to lowering temperature

1. Press **⏸** longer than 5 s.

- ✓ The room temperature controller switches over **continuously** to the lowering temperature. The lowering temperature mode is displayed, the time program is no longer displayed.

This switchover is retained until **P** reactivates the time program.



Deactivating the lowering temperature

1. Press **P** to reactivate the time program.

- ✓ The room temperature controller returns to the time program.



Note

In cooling mode the short change to lowering temperature is ignored. If the controlling device functions with automatic switching of the operating mode (HE.CO, refer to Page 13), permanent switching to lowering temperature is made note of for the next heating period and the lowering display flashes during cooling mode.

Setting the individual temperature

If the currently active setpoint temperature for the room temperature controller is not suitable (temperature is too warm or too cool) the current temperature step can be modified until the next switching point.

1. Press **S**.

✓ The currently set individual temperature flashes.

2. Set the desired temperature with + or -.

3. Confirm the set temperature with **S**.

✓ The room temperature controller returns to the normal display and regulates the set individual temperature until the next switching time in the time program. As long as the individual temperature is used for control, no operating mode (Comfort, Lowering, Anti-freeze) is displayed, since none of the temperatures stored there is valid.

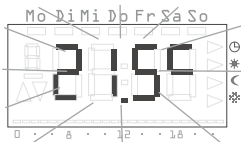

Note

If the **S** button is not pressed, the display returns to the normal display again after 5 s. Any changes to the setpoint temperature are not accepted in this case.

Reactivating the time program

1. **P** reactivates the time program.

Settings in the program menu

You can change the following settings in the program menu:

- Date and time (**Uhr** menu item)
- Temperature steps (**tEmP** menu item)
- Time program (**ProG** menu item)
- Holiday function (**UrLb** menu item)
- Anti-freeze function (**FrSt** menu item)
- Selecting the operating mode (**ModE** menu item)

Starting the program menu

1. Press **P** at least 5 s long in the normal display.
2. Select the desired menu item with + or -.
The adjacent example shows the first menu item, the time.
3. Select the desired menu item with **S**.



Setting the date and time – Uhr menu item



Notes

The clock is designed as a week-based time clock which functions for at least four hours if the power fails.

The changeover between summer and winter time is automatic.

The installed calendar automatically takes leap years into consideration.

1. Press **P** for 5 s.
2. Confirm the menu item **Uhr** with **S**.
✓ The hour display flashes.
3. Set the desired hour with **+** or **-** and confirm with **S**.



Time format

The time is either displayed in 24 hour format (0H...23H) or in the English-speaking a.m. (12AM...11AM) and p.m. format (12PM...11PM).

When setting, the display begins with the 24 hour format, and then a.m./p.m. format.

Depending on the hour format which you confirm with **S**, the time is displayed in future in 24-hour format or in **AM/PM** format.

- ✓ The hour is set and the minute display flashes.
4. Enter all further data in the same manner:
 - Minutes
 - Calendar year
 - Month
 - Day

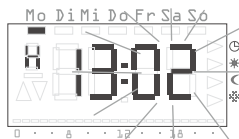

Skipping date setting

If the date is already set correctly, you can exit the setting here by pressing the **P** button.

5. Confirm each time with **S**.
✓ After the last confirmation with **S** the **Uhr** menu item is displayed.
6. Return to the normal view with **P**.

Modifying the temperature steps – tEMP menu item

You can modify the temperature steps in the **tEMP** menu item:

- Comfort temperature (default 21.0°C)
- Cooling temperature (default 24.0 °C)
- Lowering temperature (default 18.0°C)
- Anti-freeze temperature (default 10.0°C)

1. Press **P** for 5 s.
 2. Press **+** to switch from **Uhr** to **tEMP** and confirm with **S**.
- ✓ The temperature setting of the comfort temperature is displayed flashing. In addition the operating mode is displayed at the right-hand display margin.
3. Set the desired comfort temperature with **+** or **-** and confirm with **S**.
- ✓ The next temperature step is displayed (cooling temperature).
4. Set the cooling temperature and then the lowering temperature and anti-freeze temperature with **+** / **-** and confirm with **S**.
- ✓ After the last confirmation with **S** the **Uhr** menu item is displayed.
5. Return to the normal view with **P**.

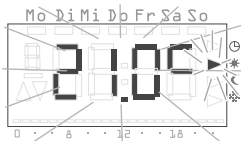

Comfort/cooling temperature display

When setting the comfort temperature or cooling temperature, an 'H' (comfort temperature) or a 'C' (cooling temperature) is displayed each time at top left.



Checking the anti-freeze temperature

The anti-freeze temperature can be checked and set again in the "Anti-freeze function" menu item. A change in the anti-freeze temperature in one of the menu items has a direct effect on the other respective menu item. Only one anti-freeze temperature is valid in a room temperature controller.

In Cooling operating mode, anti-freeze temperature is permanently set to +49°C.

Aborting modifications to the temperature steps

1. **P** aborts setting the temperature steps.
- ✓ The **Uhr** menu item is displayed. The modification to the previously opened temperature step is not saved.
2. Return to the normal view with **P**.

Modifying the time program – ProG menu item

In the **ProG** menu item the switching times of the room temperature controller are set or modified. A maximum of 32 switching times are available. Each switching time specifies a point within a week at which a change between the comfort and lowering modes takes place.

The time program is only used in the Heating operating mode. In Cooling operating mode, the time program is interrupted and the cooling temperature is used as the setpoint.

The following time program is programmed at the factory:

Weekdays	Period
Monday - Friday	6:00 -22:00 comfort temperature
Saturday, Sunday	6:00 -23:00 comfort temperature

These switching times can be modified or extended freely (in 10 minute steps).

Viewing the switching times

1. Press **P** for 5 s.
2. Press **+** several times to switch from **Uhr** to **ProG** and confirm with **S**.

- ✓ The first switching time is displayed.
- ✓ The switching times are displayed chronologically, beginning at Monday 0.00 hours, increasing to a maximum of Sunday 23.50.
- ✓ An empty switching time "--:--" is displayed at the end of the list if one is still available.



Modifying the switching time

1. Press **P** for 5 s.
 2. Press **+** several times to switch from **Uhr** to **ProG** and confirm with **S**.
 3. Select the switching time to be modified with **+** or **-** and confirm with **S**.
- ✓ The switching time is opened for editing, the hour display flashes.
4. Set the hours with **+** or **-** and confirm with **S**.
 5. Enter all further data in the same manner:
 - Minutes
 - Day – here the weekdays are initially displayed, and then the groupings Sa-Su, Mo-Fr, Mo-Sa and Mo-Su.
 - Comfort or lowering temperature

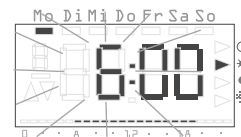

Grouping days

If a grouping of days is selected, a separate program point with the specified time and the temperature step is created for each selected day of the group.

Renewed editing of the entire grouping is not possible - only the individual program items can be edited.

6. Confirm each time with **S**.
- ✓ After the last confirmation with **S** the modified switching time is saved and the chronologically next switching time is displayed.

Inserting a new switching time

1. Press **P** for 5 s.
2. Press **+** several times to switch from **Uhr** to **ProG** and confirm with **S**.
3. With **+** or **-** select an empty switching time "--:--".
4. Confirm with **S**.



- ✓ The new switching time is opened for editing, the hour display flashes.

5. Set the hours with **+** or **-** and confirm with **S**.

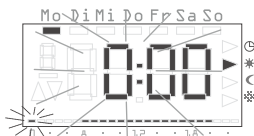

6. Enter all further data in the same manner:

- Minutes
- Day – here the weekdays are initially displayed, and then the groupings Sa-Su, Mo-Fr, Mo-Sa and Mo-Su.
- Comfort or lowering temperature



Grouping days

If you select a grouping of days, a separate switching time with the specified time and the temperature step is created for each selected day of the group.

Renewed editing of the entire grouping is not possible - only the individual switching times can be edited.

7. Confirm each time with **S**.

- ✓ After the last confirmation with **S** the modified switching time is saved and the chronologically next switching time is displayed.

Deleting a switching time

1. Press **P** for 5 s.
 2. Press **+** several times to switch from **Uhr** to **ProG** and confirm with **S**.
 3. Set the switching time to be deleted with **+** or **-**.
 4. Press and hold **+** and **-** for longer than 5 s.
- ✓ The switching time is deleted irrevocably and the chronologically following switching time is then displayed.

Deleting all switching times

With this function you can delete all stored switching times. This can, for example, be practical when a complete changeover of the time program is to be carried out and the deleting of individual program points is too time-consuming.

1. Press **P** for 5 s.
 2. Press **+** several times to switch from **Uhr** to **ProG** and confirm with **S**.
 3. Select any switching time with **+** or **-**.
 4. Press and hold **+** and **-** for longer than 10 s.
- ✓ All switching times are deleted irreversibly and a blank program point appears with the display "--:--".



Note

During this procedure the factory-programmed switching times are also deleted. These times can be restored via the Reset function.

Aborting the settings at the time program

You can **abort** the modifications at the time program if no switching time is opened for processing.

1. **P** aborts settings to the time program.

✓ The **Uhr** menu item is displayed. The modification to the previously opened switching time is not saved.

2. Return to the normal view with **P**.

Further information on programming switching times

- If no further switching time is available, no empty switching time is offered.
- **FULL** is displayed when a group of days is to be programmed but insufficient switching times are available. The number of free switching times is simultaneously displayed.
- If a group of days covers an existing switching time, the existing switching time is overwritten without a query.
- If a switching time is placed on the time period of an existing switching time, the existing switching time is overwritten without a query.
- If an existing switching time is modified and placed on a time period which is already occupied by an existing switching time, the existing switching time is overwritten without a query.
- Redundant switching times (switching times in the time program which do not cause a change in the temperature step) are not recognised or removed automatically. Such switching times must be manually searched for and deleted if further free switching times are required.

Setting the holiday program – UrLb menu item

For temperature regulation during your absence. In the **UrLb** menu item the beginning and end dates of the absence are set. During this period the system regulates to a constant selectable temperature step. After the holiday period has expired the holiday program is deleted automatically so that it is not repeated every year.

The holiday program is only used in the Heating operating mode. In Cooling operating mode, a running holiday program is suppressed and the cooling temperature is used as the setpoint.

Setting the holiday period

1. Press **P** for 5 s.

2. Press **+** several times to switch from **Uhr** to **UrLb** and confirm with **S**.

✓ When the **UrLb** menu item is entered the unit displays either:

- "--.--" if no holiday period has been defined yet

or

- the beginning date of a previously entered holiday.

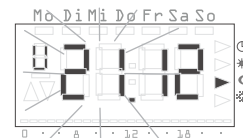

3. Press **S** to set the holiday period or to modify the date.

✓ The current date is entered automatically as the holiday beginning. This date can be changed:

✓ The month is displayed flashing.

4. Set the month with **+** or **-** and confirm with **S**.

✓ The day begins to flash.

5. Set the day with **+** or **-** and confirm with **S**.

- ✓ The display changes to the holiday end.
 - ✓ The month is displayed flashing.
6. Use the same procedure to set the holiday end (month and day).
 7. Confirm each time with **S**.
 - ✓ The operating mode is displayed flashing.
 8. Press the + or - button to select the desired temperature step (Comfort, Lowering or Anti-Freeze) to be maintained during the holiday.
 9. Confirm with **S**.
 - ✓ After confirming with **S** the Uhr menu item is displayed.
 10. Return to the normal view with **P**.

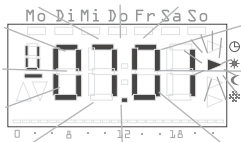

- ✓ As soon as the internal date reaches the specified holiday day at 0:00 hours, the temperature step is changed. The view in the display changes and displays the holiday end date.



Deleting the holiday period

After the holiday period has expired the holiday program is deleted automatically so that it is not repeated every year.

To manually delete the holiday program:

1. Press **P** for 5 s.
2. Press + several times to switch from **Uhr** to **UrLb** and confirm with **S**.
- ✓ The beginning date of the holiday entered is displayed.
3. Press and hold the + and - button for longer than 3 s in order to delete a specified holiday period.
- ✓ The room temperature controller returns to the **Uhr** menu item.
4. Return to the normal view with **P**.

Activating/deactivating the anti-freeze function – FrSt menu item

The anti-freeze function can only be permanently activated via this menu item.



Anti-freeze temperature

The anti-freeze temperature can be set in the range of +5°C to +15°C in the Heating operating mode. In Cooling operating mode the anti-freeze temperature is permanently set to +49°C.

Modifying the anti-freeze temperature also acts on the anti-freeze temperature set under "Modifying temperature steps" (refer to Page 8).

1. Press **P** for 5 s.
2. Press + several times to switch from **Uhr** to **FrSt** and confirm with **S**.

- ✓ The anti-freeze temperature is displayed flashing. In addition the corresponding operating mode is displayed flashing at the right-hand display margin.

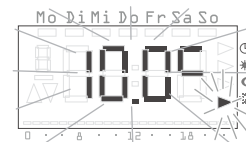

3. Set the desired anti-freeze temperature with + or - and confirm with **S**.

- ✓ The display shows **On** or **OFF**.

4. Activate the anti-freeze with + (**On**), and deactivate with - (**OFF**).

5. Confirm with **S**.

- ✓ The anti-freeze function is activated or deactivated and the display returns to the **Uhr** menu item.

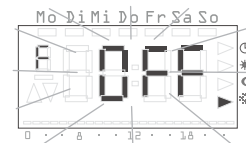

6. Return to the normal view with **P**.

Behaviour after deactivating the anti-freeze function

- ✓ After the anti-freeze function has been deactivated the room temperature controller changes to continuous Lowering mode.

1. **P** reactivates the normal time program.

Selecting the operating mode – ModE menu item

The following operating modes can be selected in the **ModE** menu item:

Operating mode	Display
automatic switching of Heating/Cooling operating modes via the K input*	HE.CO*
continuous heating mode	HE. __
continuous cooling mode	__.CO

* Factory setting

1. Press **P** for 5 s.
 2. Press **+** several times to switch from **Uhr** to **ModE** and confirm with **S**.
 3. Set the desired operating mode with **+** or **-**.
 4. Confirm with **S**.
- ✓ The room temperature controller returns to the **Uhr** menu item.
5. Return to the normal view with **P**.

Locking buttons

Locking of the buttons prevents either accidental or unauthorised operation of the radio room temperature controller.

Activating button locking function

1. Press and hold **S** and **-** for longer than 5 s until "-- --" is displayed.

Deactivating button locking function

1. Press and hold **S** and **-** for longer than 5 s until "-- --" is no longer displayed.



Cleaning the room temperature controller

1. Use only a spray-moistened cloth to wipe the housing of the room temperature controller.
2. Do not use any cleaning agents. These may damage the housing.

Warranty

The warranty is provided in accordance with statutory requirements via the specialist trade.

Please submit or send faulty devices postage paid together with an error description to your responsible salesperson (specialist trade/installation company/specialist electrical trade).

They will forward the devices to the Gira Service Center.

Gira
Giersiepen GmbH & Co. KG
Electrical Installation
Systems
P.O. Box 1220
42461 Radevormwald
Germany
Phone +49 (0) 2195 / 602 - 0
Fax +49 (0) 2195 / 602 - 339
www.gira.com
info@gira.com

Mounting Instructions and Start-Up
for the Electrician

Room temperature controller clock with cooling function
2370 ..

GIRA

Table of contents

About these instructions	3
Method of functioning	3
Installation	4
Installation and safety instructions	4
Selecting installation site	4
Installation	4
Electrical connection	5
Start-up (basic setting)	5
Normal display (n)	6
Operating mode (b)	6
Differential gap (d)	7
Limiting temperature for heating (G)	7
Limiting temperature for cooling (C)	7
Temperature at the external sensor (F)	7
Minimum ON period (t)	7
Sensor offset (o)	8
Heating optimisation (E)	8
Gradient for heating optimisation (r)	8
Summertime regulation (S)	8
Accuracy (U)	9
Software version (-)	9
Resetting all the settings (Reset)	9
What does it mean when... ..	9
... "FULL" is shown in the display?	9
... "FAIL" is shown in the display?	9
... "--" is shown in the display?	9
Technical data	10

About these instructions

The following symbols and marks are used in these instructions:

1. Action instructions are numbered consecutively.
- F Results of actions are identified by this check mark.
- Enumerations are identified by this point.



Note!

Information on the economical use of the room temperature controller is identified by this sign.



Important

Information on facts which may lead to damage or injury to persons or the device are identified by this sign

Method of functioning

The room temperature controller is an electronic controlling device with an integral clock that can activate a temperature or time controlled switching relay and thus switch electrical loads on or off with a maximum current of 8 A ($\cos \varphi = 1$).

Temperature measurement can be implemented optionally via an integrated detector or an optional external detector.

Within one hour of continuous heating, the room temperature controller automatically interrupts the heating process for 5 minutes (the heater is switched off).

Installation



Electrical devices may only be mounted and connected by electrically skilled persons.



Important

Installation and mounting of electrical devices may only be carried out by a qualified electrician.
Errors during connecting may lead to damage to the controlling device!
No liability is accepted for damage caused by incorrect connection and/or improper handling!

Installation and safety instructions

- Before working on the room temperature controller de-energize the device and secure against restarting!
- Only connect the room temperature controller to fixed wiring in closed dry rooms.
- Ensure that lines with supply voltage, such as the power supply and relay connection cables do not come into contact with low-voltage lines such as sensor lines (minimum distance 4 mm at basic-insulated lines).
- Lay the base sensor of the room temperature controller in a sensor conduit. If an open sensor conduit is to be used, close it with a plug so that tile bonding agent or cast plaster cannot enter the sensor conduit, causing the sensor to be damaged.
Only use sensors with protection class II with a cable of at least H03VV-F.

Selecting installation site

The room temperature controller is installed in a flush-mounted box. Please observe the following points for optimal operation:

- We recommend an optimum mounting height of 1.50 m.
- Do not subject the room temperature controller to direct sun radiation or use it in the area of draughts or other temperature-influenced air (such as over electric cookers, refrigerators, etc. or in the area of direct radiation heat of radiators), since the control behaviour can be influenced by heat.
- Do not use the room temperature controller in a physical unit with other electrical devices, such as dimmers, since a possible heat development could influence the room temperature controller.
- When used with an external temperature sensor an empty conduit (flexible or firm plastic tube) has to be laid, for example in the flooring, until the measuring point. Select an installation location for the external sensor at which the room temperature can be measured as neutrally as possible.

Installation

1. Connect the flush-mounted insert of the room temperature controller in accordance with wiring diagram (also refer to Page 5).
2. Install flush-mounted insert into flush-mounted box (connection terminals downwards).
3. Apply the cover frame and attach the room temperature controller top unit.
4. Activate voltage and start up the room temperature controller:
 - Set the time and date (Operating instructions, Page 7),
 - Carry out modifications in the parameter menu (from Page 5).

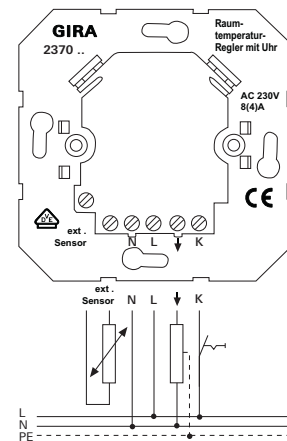

Electrical connection

All the connecting terminals are equipped with slotted screws for screwdriver installation. A common screwdriver with a 3 mm blade is recommended.

The connection has 6 terminals:

- 1 - ext. sensor (connection of external temperature sensors)
- 2 - ext. sensor (connection of external temperature sensors)
- 3 - N
- 4 - L
- 5 - ▼ (relay contact with equipotential bonding)
- 6 - K (heating/cooling switchover input - control with L, the same phase!)

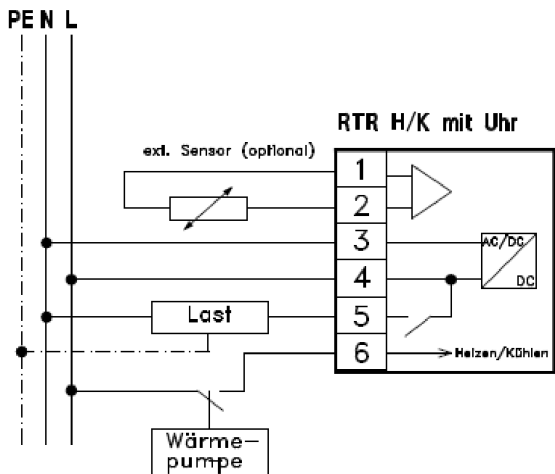

Start-up (basic setting)

The parameters required for start-up can be defined in this menu.

The works settings are preset to ensure proper operation even without adaptations in the parameter menu.



Important information on changes in the parameter menu

Changes in this menu should only be carried out by qualified persons since incorrect settings may result in proper control operation no longer being possible.

In order to change to the parameter menu:

1. Press and hold the **S** and **P** buttons simultaneously for longer than 5 s in the normal display.

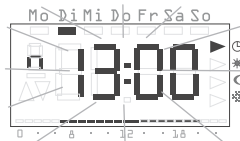

2. Select the desired parameter with **+** and **-**.
3. The respective parameter is opened for modification by pressing the **S** button. The parameter value flashes.
4. When a parameter has been modified and confirmed with **S**, the parameter menu changes automatically to the next parameter.
5. The **P** button can be used at any time to return to the normal time program.

The following parameters can be set or read:

Display	Parameter
n (normal)	Normal display (time, setpoint temperature, actual temperature)
b (operation)	Operating mode: internal sensor, external sensor or internal sensor with limit
d (diff)	Differential gap = hysteresis
G (limit)	Limiting temperature for heating
C (Cooling)	Limiting temperature for cooling
F (sensor)	Temperature at the external sensor
t (time)	Minimum ON period in seconds [s]
o (offset)	Sensor offset in order to compensate constructional influences
E (early)	Heating optimisation
r (ramp)	Gradient of the heating optimisation in minutes per Kelvin [min/K]
S (summertime)	Specifies which summertime regulation (Central European or GB) is used for calculation
U (clock)	Correction value for accuracy in seconds per day [s/d]
-	Software version



Modifications in the parameter menu

Modifications to the parameters are implemented immediately! The parameter is regarded as modified, irrespective of whether the menu is exited with **S** or **P** or whether the system returns automatically to the normal display after a few seconds.

Normal display (n)

Factory setting: Time (current time of day)

The normal display of the room temperature controller is defined here. Normal display is always shown on the display when no menu has been selected and no holiday settings are active.

1. Open the parameter **n** for processing with **S**.
2. One of the following displays are selected with **+** and **-**.
3. Confirm with **S** and switch to the next parameter or return to the normal time program with **P**.

Normal display	Display
Current time of day	Clock*
Current setpoint temperature	NOMINAL
Current actual temperature	Actual

* Factory setting

Operating mode (b)

Factory setting: I. (internal sensor)

The function type for the room temperature controller is defined here. Settings are made for sensor selection for temperature controlling and the limiting function.

1. Open the parameter **b** for processing with **S**.
2. Select the desired operating mode with **+** and **-**.
3. Confirm with **S** and switch to the next parameter or return to the normal time program with **P**.

Reference variable	Floor temperature limit	Display
Internal sensor	---	I.*
External sensor	---	E.
Internal sensor	External sensor	IE.

* Factory setting

Differential gap (d)

Factory setting: ± 0.2 °C

This parameter defines the differential gap (hysteresis) of the controlling function.

1. Open the parameter **d** for processing with **S**.
2. Use + and - for setting the switching differential.
3. Confirm with **S** and switch to the next parameter or return to the normal time program with **P**.

The relay is switched off if the current temperature lies over the setpoint temperature by the value set here (Heating operating mode).

The relay is activated again if the actual temperature lies below the setpoint value by the value set here (Heating operating mode).

Limiting temperature for heating (G)

Factory setting: + 45 °C

Parameter for individually limiting the floor temperature in heating mode. If the limiting function is activated (operating mode with limiting function selected), the relay is deactivated as soon as the temperature measured at the external sensor exceeds the temperature set here.

1. Open the parameter **G** for processing with **S**.
2. Use + and - to set the limiting temperature in the range of + 5 °C to + 55 °C.
3. Confirm with **S** and switch to the next parameter or return to the normal time program with **P**.

The limiting function does not have a differential gap, so that switching is carried out immediately if the value exceeds the limit value.

Limiting temperature for cooling (C)

Factory setting: + 18 °C

Parameter for individually limiting the floor temperature in cooling mode. If the limiting function is activated (operating mode with limiting function selected), the relay is deactivated as soon as the temperature measured exceeds the temperature set.

1. Open the parameter **C** for processing with **S**.
2. Use + and - to set the limiting temperature in the range of + 5 °C to + 55 °C.
3. Confirm with **S** and switch to the next parameter or return to the normal time program with **P**.

The limiting function does not have a differential gap, so that switching is carried out immediately if the value drops below the limit value.

Temperature at the external sensor (F)

With external sensor operation the current temperature value is displayed here. This value cannot be modified.

If an operating mode which only operates with the internal sensor is selected, "--.--" is displayed.

1. Switch to the next parameter with **S** or return to the normal time program with **P**.

Minimum ON period (t)

Factory setting: 20 s

In order to prevent frequent relay switching, this parameter can be used to specify the minimum ON period. This period specifies the minimum amount of time for which the relay is to remain on when a request has activated the relay.

1. Open the parameter **t** for processing with **S**.
2. Use + and - to set the minimum ON period in the range of 20 to 500 s in 10 s steps.
3. Confirm with **S** and switch to the next parameter or return to the normal time program with **P**.

Sensor offset (o)

Factory setting: 0.0 K

The measured actual temperature can be displaced by ± 3.0 Kelvin with this parameter. This correction can be used to compensate the measuring deviations which arise though the unfavourable placing of the room temperature controller.

1. Open the parameter **o** for processing with **S**.
2. Use the **+** and **-** buttons for setting sensor offset.
3. Confirm with **S** and switch to the next parameter or return to the normal time program with **P**.

The value set here is always applied to the respective active sensor (external or internal temperature sensor, depending on the operating mode selected) which is used for the temperature control.

Heating optimisation (E)

Factory setting: On

The heating optimisation determines the temporal behaviour of the room on the basis of past heating processes and calculates the required derivative action time required to reach the desired setpoint temperature on time in the Heating operating mode.

The automatic heating optimisation can be activated (**On**) and deactivated (**OFF**) here. If the heating optimisation is deactivated, switching is carried out exactly as specified in the time program.

1. Open the parameter **E** for processing with **S**.
2. The **+** button can be used to set the heating optimisation to **On** and the **-** button to **OFF**.
3. Confirm with **S** and switch to the next parameter or return to the normal time program with **P**.

Gradient for heating optimisation (r)

The current gradient which is used to calculate the derivative action time can be checked under this menu item. The time required to heat the room by one Kelvin (1K) is displayed here in minutes. If the heat optimisation is activated, this gradient is always recalculated during a transition from a lowering phase to a comfort phase. The heating optimisation is set to a gradient of 15 minutes per Kelvin in our works.

This value cannot be modified.

1. Switch to the next parameter with **S** or return to the normal time program with **P**.

Summertime regulation (S)

Factory setting: EUR = Central Europe

This is used for defining when the changeover from normal time to summertime and vice versa is to be carried out. The room temperature controller differentiates between Central Europe and Great Britain.

1. Open the parameter **S** for processing with **S**.
2. Select a summertime regulation with **+** or **-**.
3. Confirm with **S** and switch to the next parameter or return to the normal time program with **P**.

Regulation for	Summertime start	Summertime end	Display
Central Europe	Last Sunday in March from 2:00 h to 3:00 h	Last Sunday in October from 3:00 h to 2:00 h	EUR*
Great Britain	Last Sunday in March from 2:00 h to 3:00 h	Fourth Sunday in October from 3:00 h to 2:00 h	Gb
Off	---	---	OFF

* Factory setting



Information on the summertime function

If the summertime function is deactivated (**OFF**), an automatic changeover of the time is not carried out. In this case the time changeover must be manually carried out.

Accuracy (U)

Here a correction value is entered at the factory, which ensures the greatest possible precision of the clock function.

The value represents the correction amount in seconds per day and cannot be changed.

1. Switch to the next parameter with **S** or return to the normal time program with **P**.

Software version (-)

The currently installed software version can be interrogated here.

1. Switch to the next parameter with **S** or return to the normal time program with **P**.



Specifying the software version

When reporting technical problems or unwanted side-effects always specify the version of the software installed in the controlling device.

Resetting

You can delete all the parameter settings and programming and reset the device to the standard factory values:

1. Press and hold the **+** and **-** buttons simultaneously for longer than 10 s in normal display.
- F The controlling device then carries out its display test and offers the clock setting for the first start-up.

What does it mean when...

... "FULL" is shown in the display?

FULL is displayed in the ProG menu when a group of days is to be programmed but insufficient switching times are available. The number of free switching times is simultaneously displayed.

... "FAIL" is shown in the display?

- Improper use:
The top unit of the room temperature controller is protected against unintentional placing on the flush-mounted insert of a Gira blind controller.
When used incorrectly the room temperature controller displays the flashing text **FAIL**.
- Temperature at the external sensor:
With use of an external sensor this is tested for correct functioning. If the sensor is defective, the supply cable interrupted or short-circuited, **FAIL** is shown in the display.
For precise definition of the defect, control the value in the "Temperature at the external sensor (F)" parameter menu (refer to Page 7):
 - below + 3.5 °C: Short-circuit in the sensor line or in the sensor
 - above + 85 °C: Sensor line is interrupted or sensor is broken

... "--.--" is shown in the display?

If "--.--" is displayed when buttons are pressed, button locking is active.

Technical data

Operating voltage:	230 V AC, 50 Hz
Power consumption:	approx. 3.7 VA
Contact type:	1 NO contact, with equipotential bonding (relay contact)
Switching input:	L (in phase) to terminal K, 0 = Heating 1 = Cooling
Max. perm. switching current:	8 A ($\cos \varphi = 1$)
Electrical life:	at least 10×10^4 switching cycles
Impulse withstand level:	4.0 kV
Temperature ranges:	+ 10 to + 40 °C (comfort and lowering temperature) + 10 to + 40 °C (cooling temperature) + 5 to + 15 °C (anti-freeze temperature) + 5 to + 55 °C (limiting temperature) (Increment 0.5 K each)
Temp. differential gap:	± 0.1 to ± 1.3 K, settable (0.1K increments)
Sensor:	semiconductor sensor (KTY), internal and/or external
Program slots:	32, as desired during the week Increment 10 minutes
Power reserve:	at least 4 hours via Gold Cap (capacitor, no battery)
Minimum ON period:	20 s to 500 s (10 s increments)
Deadlock protection:	after 7 days of non-operation of the relay at 10:00 o'clock on the following day
Type of action:	1.C (no limitation type of action)
Pollution severity:	2
Permissible ambient temperature:	0 to + 50 °C
Protection type:	IP 30
Protection class:	The protection against electric shock to live parts complies with the requirements of protection class II (reinforced insulation)