

Issue:  
22.07.2016  
22243100

## Control unit 1-10 V, 4-gang with manual operation Order No. 2224 00



## Table of Contents

<b>1</b>	<b>Product definition</b>	<b>4</b>
1.1	Product catalogue	4
1.2	Function	4
<b>2</b>	<b>Mounting, electrical connection and operation</b>	<b>5</b>
2.1	Safety instructions	5
2.2	Device components	6
2.3	Fitting and electrical connection	7
2.4	Commissioning	9
2.5	Operation	10
<b>3</b>	<b>Technical data</b>	<b>11</b>
<b>4</b>	<b>Software description</b>	<b>13</b>
4.1	Software specification	13
4.2	Software "Control unit 302911"	14
4.2.1	Scope of functions	14
4.2.2	Notes on software	16
4.2.3	Object table	17
4.2.3.1	Channel-independent objects	17
4.2.3.2	Objects of the dimming channels	20
4.2.3.3	Objects of the independent switching channels (optional)	24
4.2.4	Functional description	26
4.2.4.1	Description of channel-independent functions	26
4.2.4.1.1	Configuration of the inputs and outputs	26
4.2.4.1.2	Delay after device reset	30
4.2.4.1.3	Central function	31
4.2.4.1.4	Collective feedback	32
4.2.4.2	Functional description of the dimming channels	36
4.2.4.2.1	Function diagram and priorities	36
4.2.4.2.2	Definition of the brightness range	37
4.2.4.2.3	Dimming characteristic, dimming behaviour and dimming speeds	41
4.2.4.2.4	Response after a device reset	48
4.2.4.2.5	Feedback for switching status and brightness value	51
4.2.4.2.6	Timing functions	56
4.2.4.2.7	Soft ON/OFF function	57
4.2.4.2.8	Automatic switch-off	59
4.2.4.2.9	Staircase function	61
4.2.4.2.10	Scene function	70
4.2.4.2.11	Burn-in function	74
4.2.4.2.12	Supplementary function	77
4.2.4.3	Functional description of the independent switching channels	81
4.2.4.3.1	Function diagram and priorities	81
4.2.4.3.2	Relay operating mode	82
4.2.4.3.3	Response after a device reset	83

4.2.4.3.4	Feedback for the switching status .....	86
4.2.4.3.5	Cyclical monitoring .....	89
4.2.4.3.6	Timing functions .....	90
4.2.4.3.7	Staircase function .....	91
4.2.4.3.8	Scene function .....	97
4.2.4.3.9	Supplementary function .....	100
4.2.4.4	Operating hours counter .....	104
4.2.4.5	Delivery state .....	108
4.2.5	Parameters .....	109
4.2.5.1	General parameters .....	109
4.2.5.2	Parameters of the dimming channels .....	114
4.2.5.3	Parameters of the independent switching channels .....	140
<b>5</b>	<b>Appendix .....</b>	<b>156</b>
5.1	Index .....	156

## 1 Product definition

### 1.1 Product catalogue

Product name: Control unit 1-10 V, 4-gang, RMD

Use: Actuator

Design: RMD (rail-mounted device)

Order No. 2224 00

### 1.2 Function

The control unit switches and dims electrical consumers with a 1-10 V interface (e.g. fluorescent lamps with electronic 1-10 V electronic ballasts, RGB-LED luminaires with integrated 1-10 V drivers). As an actuator, the control unit receives telegrams from push-button sensors, control panels or comparable controllers via the KNX and converts the received commands into switching or dimming actions. Dimming always takes place via variation of the 1-10 V voltage, provided by the consumers, at the inputs E1...E4. The switching function is implemented by relay contacts at the outputs A1...A4. This switches the power supply of the consumers.

5 device configurations can be selected, causing the allocation of the 4 individually-controllable dimming channels to the switching outputs. This means that, optionally, 1-10 V dimming channels can be combined to execute a shared switching action, in order to implement different control tasks (e.g. 4 dimming channels act on a switching relay to activate an RGBW luminaire or 4 dimming channels act in pairs, each on one relay, to separate two load circuits). Relay outputs not allocated to any dimming channel can be used as freely acting switching actuator channels.

The control unit possesses a bistable relay, so that switching states can remain set unchanged as required, even if there is a bus voltage failure. The switching contacts are specially designed for loads with a capacitive character.

With the sliding switches on the device front panel, the relays can be switched on and off manually. This takes place independently of the activation via the KNX and is thus also possible without bus voltage or in an unprogrammed state. This feature permits fast checking of connected loads for proper functioning.

The function features that are adjustable by means of the ETS include, for example, separately configurable brightness ranges, extended feedback functions, disabling, or alternatively, forced position functions, logic operation functions, separately adjustable dimming behaviours and dimming characteristics, soft dimming functions, time delays and staircase functions.

Furthermore, dimming and switching channels can be integrated in up to 10 scenes with various brightness values or switching states. Central switching of all channels is possible, too. If necessary, a burn-in function allows the commissioning of new fluorescent lamps as required by lamp manufacturers for compliance with the electrical and light values and for basic stabilisation.

The switch-on times of the relay outputs can be detected and evaluated individually by operating hours counters.

For project design and commissioning of the device, ETS4 from Version 4.2 onwards or ETS5 is required.

The device is wholly supplied by the connected KNX line and thus does not require any external power supply. The device is designed for mounting on DIN rails in closed compact boxes or in distributors in fixed installations.

## 2 Mounting, electrical connection and operation

### 2.1 Safety instructions



Electrical devices may only be mounted and connected by electrically skilled persons.

**Serious injuries, fire or property damage possible. Please read and follow manual fully.**

**Danger of electric shock. Device is not suitable for disconnection from supply voltage.**

**Danger of electric shock. The 1...10 V control voltage is a functional extra-low voltage (FELV), and can be connected to mains potential. On installing, ensure safe separation to SELV/PELV systems. In order to disconnect the connected luminaires, disconnect both the mains voltage and control voltage circuits.**

## 2.2 Device components

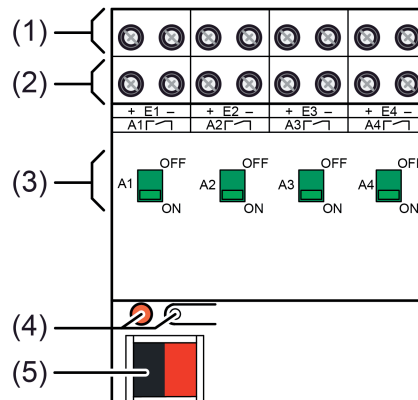

Figure 1: Device components

- (1) Connection of 1-10 V control inputs (E1...E4)
- (2) Connection for switching outputs (A1...A4)
- (3) Slide switch / Status indication
- (4) Programming button and LEDs
- (5) KNX connection

## 2.3 Fitting and electrical connection



### DANGER!

Electrical shock when live parts are touched.

Electrical shocks can be fatal.

Before working on the device, disconnect the power supply and cover up live parts in the working environment.

### Fitting the device

- Snap onto a suitable DIN rail. The screw terminals of the valve outputs should be at the top.
- i** A KNX data rail is not required.
- i** Observe the temperature range (see Technical Data) and ensure sufficient cooling, if necessary.

### Connecting the device

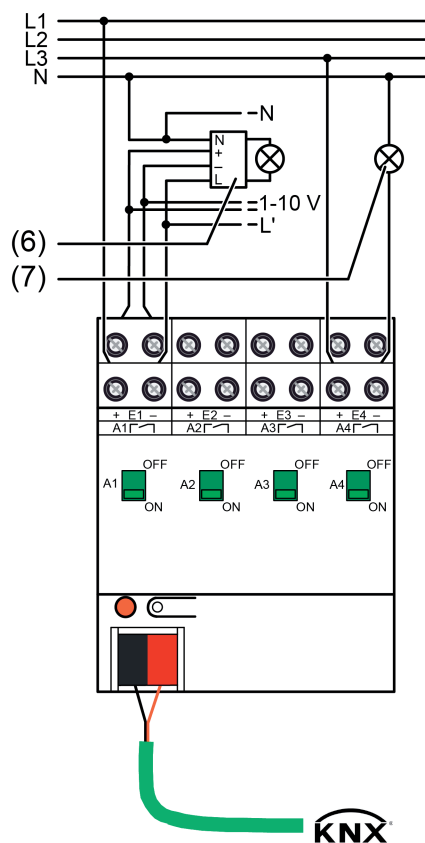

Figure 2: Connection example

(6) Lamp operation device with 1-10 V interface

(7) Optional additional switched load, e.g. luminaire (switching actuator operation)

Control cable: appropriate type, cross-section and routing for the specifications for mains voltage cables. 1-10 V and mains voltages wires can be run together in a cable, e.g. NYM 5x1.5 mm<sup>2</sup>.

### Precondition:

The use of the switching outputs to activate lamp operation devices (6) or additional consumers (7) is dependent on the configuration of the device in the ETS. Before connection, check the intended configuration! In the as-delivered state, all 4 switching outputs are independently assigned to the 4 dimming channels.

Only use lamp operating devices that are of the same type, the same power level, and from the same manufacturer. Otherwise there may be brightness differences between the individual lamps.

The maximum number of lamp operating devices that can be connected is a function of the sum of the control voltages that feed these devices.

- i** Electronic lamp operating devices generate high current spikes when they are switched on, that can result in sticking of the relay contacts. Note the switch-on currents and technical data. In the case of loads with high switch-on current, use switch-on current limiter or separate load protection.
  - Connect the lamp operating devices (6) and optional additional consumers (7) according to the connection diagram (Figure 2).
- i** The 1-10 V inputs E1...E4 are current sinks, which - depending on the available constant current from the electronic ballasts - can continuously control the voltage between the terminals "+" and "-" in the range between 0.8 V (depending on the configured basic brightness) and 10 V (see page 37-38). These inputs do not actively make any voltage available themselves (no integrated power supply unit).
- i** The "-" terminals of the 1-10 V inputs E1...E4 are bridged internally within the device.
- i** Various phase conductors can be connected to the terminals A1...A4.
  - If multiple circuit breakers supply dangerous voltages to the device or load, couple the miniature circuit breakers or label them with a warning, to ensure disconnection is guaranteed.

### Installing / removing the protective cap

To protect the bus lines against hazardous voltages in the area of the connecting terminals, a protective cap can be installed.

The cap is installed with the bus terminal in place and the connected bus line led out at the rear.

- To install the cap: slide the cap over the bus terminal until you feel it engage (Figure 3).
- To remove the cap: Remove the cap by pressing the sides slightly and by pulling it out to the front (Figure 3).

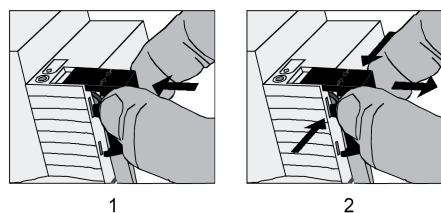

Figure 3: Installing / removing the protective cap for the bus connection



## 2.4 Commissioning

### Commissioning with the ETS

---



**DANGER!**

**Electrical shock when live parts are touched.**

**Electrical shocks can be fatal.**

**Before working on the device, disconnect the power supply and cover up live parts in the working environment.**

---

Precondition:

Make sure that the bus voltage is available interruption free during the commissioning.

- Switch on the bus voltage.  
Check: When the programming button is pressed, the red programming LED must light up.
  - Configure and program the physical address with the help of the ETS.
  - Programming the application data with the ETS.  
The device is ready for operation.
- i** The switching outputs of the actuator can be actuated via manual operation, even if there is no bus voltage or if the actuator is not yet programmed. An adjustment of the sliding switches is not detected by the application controller of the device.

## 2.5 Operation

### Switching relay contacts manually

The switching position of the relays is indicated by slide switches (3) on the front panel of the device (Figure 1). At the same time the slide switches can be used for manual operation of the relay outputs. Use a suitable tool for actuation (e.g. thin slotted screwdriver).

- Move slide switch to **ON** position.  
Relay contact is closed, load is switched on.
- Move slide switch to **OFF** position.  
Relay contact is open, load is switched off.

**i** The switching outputs of the actuator can be actuated via manual operation, even if there is no bus voltage or if the actuator is not yet programmed. An adjustment of the sliding switches is not detected by the application controller of the device. In consequence, even if the bus voltage is switched on, no feedback is transmitted on a manual actuation.

**i** Outputs disabled via bus telegram can still be switched manually.

## 3 Technical data

### General

Ambient temperature	-5 ... +45 °C
Storage/transport temperature	-25 ... +70 °C
Installation position	as desired (preferably top output terminals)
Fitting width	72 mm / 4 modules
Minimum distances	none
Fixing type	Snapping onto top hat rails in closed housing (e.g. small distribution board, etc.)

### KNX

Test mark	KNX/EIB
KNX medium	TP 256
Commissioning mode	S-mode
Rated voltage KNX	DC 21 ... 32 V SELV
Current consumption KNX	max. 6 mA
Current consumption KNX	min. 5.6 mA
Power loss	max. 4 W

### Control inputs

Control voltage	1 ... 10 V
Control current	max. 100 mA Per channel
Cable length	max. 500 m (0.5 mm <sup>2</sup> )

### Switching outputs

Contact type	μ contact
Switching voltage	AC 250 / 400 V
Switching current 230 V AC 1	16 A
Switching current 230 V AC 3	10 A
Switching current 400 V AC 1	10 A
Switching current 400 V AC 3	6 A
Fluorescent lamps	16 AX
Switching voltage DC	DC 12 ... 24 V
Switching current DC	16 A
Minimum switching current	100 mA
Switch-on current 150 μs	600 A
Switch-on current 600 μs	300 A
Ohmic load	3680 W
Capacitive load	16 A / 200 μF

### Lamp loads

Incandescent lamps	3680 W
HV halogen lamps	3680 W
LV halogen lamps with inductive transformer	2000 VA
LV halogen lamps with Tronic transformer	2500 W
Fluorescent lamps T5/T8	
uncompensated	3680 W
parallel compensated	2500 W / 200 μF
twin-lamp circuit	3680 W / 200 μF
Compact fluorescent lamps	
uncompensated	3680 W
parallel compensated	2500 W / 200 μF
Mercury vapour lamps	
uncompensated	3680 W
parallel compensated	3680 W / 200 μF

## Connection

single stranded

Finely stranded without conductor sleeve

Finely stranded with conductor sleeve

0.5 ... 4 mm<sup>2</sup>

0.34 ... 4 mm<sup>2</sup>

0.14 ... 2.5 mm<sup>2</sup>

## 4 Software description

### 4.1 Software specification

ETS search paths: Illumination / Dimmer / Control unit 1-10 V, 4-gang, RMD  
PEI type: "00"<sub>Hex</sub> / "0"<sub>Dec</sub>  
PEI connector: no connector

#### Application:

No.	Short description	Name	Version	from mask version
1	Multifunctional application for the activation of electrical consumers with 1-10 V interface. Optionally with independent switching actuator function.	Control unit 302911	1.1 for ETS4 Version 4.2, ETS5	SystemB (07B0)

## 4.2 Software "Control unit 302911"

### 4.2.1 Scope of functions

#### General

- 5 device configurations can be chosen. This means that the 4 individually activatable dimming channels can be assigned to the switching outputs (optional combination of the 1-10 V dimming channels to execute a shared switching action, e.g. 4 dimming channels act on a switching relay to activate an RGBW luminaire or 4 dimming channels act in pairs, each on one relay, to separate two load circuits).
- If required, relay outputs not allocated to any dimming channel can be used as freely acting switching actuator channels.
- Behaviour in case of bus voltage failure and bus voltage return as well as after ETS programming presettable.
- Manual operation of outputs independently of the bus (for instance, construction site mode) with mechanical switching state display.
- Delay for actively transmitting feedbacks after bus voltage return.
- Up to three central switching functions for joint activation of all the dimming and switching channels.
- The switch-on times of the relay outputs can be detected and evaluated by operating hours counters.
- Collective feedback of all switching states possible.

#### Dimming channels

- 4 individually activatable dimming channels are available.
- Feedback of switching state and brightness value (only for bus operation): Active or passive feedback function. Update behaviour and cyclical transmission configurable for active feedback.  
When individual or all the dimming channels are combined to a relay output (depending on the configuration), the shared relay status and the individual dimming channel switching status can be fed back.
- Setting of the dimmable brightness range is possible ("basic brightness and maximum brightness" or "minimum brightness and maximum brightness").
- Dimming behaviour (also fading) and dimming characteristics configurable.
- The response of a dimming channel in the state "OFF" when receiving a relative dimming command can be configured (switch on and dim up or no reaction).
- Soft switch-on and soft switch-off function.
- Disabling function, or alternatively, forced position function is configurable for each dimming channel. During a disabling function, the flashing of connected luminaires is not possible.
- Timing functions (switch-on delay, switch-off delay, staircase lighting timer) With the staircase lighting timer the reaction at the end of the switch-on time can be configured (pre-warning function by means of time-controlled reduction of the lighting or activation of the permanent lighting, e.g. for hallways).
- Logic operation function configurable.
- A dimming channel can be integrated in up to 10 light-scenes.
- If necessary, a burn-in function allows the commissioning of new fluorescent lamps as required by lamp manufacturers for compliance with the electrical and light values and for basic stabilisation.

#### Switching actuator operation (optional)

- Independent switching of the switching outputs A2...A4.
- Operation as NO or NC contacts.

- Feedback of switching state (only for bus operation): Active or passive feedback function. Update behaviour and cyclical transmission configurable for active feedback.
- Logic function individual for each switching output.
- Disabling function can be parameterized for each channel. Forced position function separately for each switching output as an alternative.
- Timing functions (switch-on delay, switch-off delay, staircase lighting timer, also with pre-warning function)
- Incorporation into light moods: up to 10 internal scenes parameterizable per switching output.
- Configurable cyclical monitoring of the incoming switching telegram.

## 4.2.2 Notes on software

### ETS project design and commissioning

For project design and commissioning of this device, we recommend using the ETS4 of Version 4.2 onwards or ETS5. Project designing and commissioning of the device using ETS2 or ET3 is not possible.

### Safe-state mode

If the device - for instance as a result of errors in the project design or during commissioning - does not work properly, the execution of the loaded application program can be halted by activating the safe-state mode. The safe-state mode does not permit activation of the dimming and switching channels via the KNX. The actuator remains passive in safe-state mode, since the application program is not being executed (state of execution: Terminated). Only the system software is still functional so that the ETS diagnosis functions and also programming of the device continue to be possible. In addition, the relays can be adjusted via manual operation.

### Activating the safe-state mode

- Switch off the bus voltage or remove the bus terminal. Wait a bit.
- Press and hold down the programming button.
- Switch on the bus voltage or attach the bus terminal. Release the programming button only after the programming LED starts flashing slowly.

The safe-state mode is activated. With a new brief press of the programming button, the programming mode can be switched on and off as usual also in the safe-state mode. If Programming mode is active, the programming LED stops flashing.

-  The safe-state mode can be terminated by switching off the bus voltage or by programming with the ETS.

### Unloading the application program

The application program can be unloaded with the ETS. In this case the device is without function. However, manual operation remains possible through mechanical adjustment of the sliding switch.



## 4.2.3 Object table

Number of communication objects:	104 (max. object number 284 - gaps in between)
Number of addresses (max.):	760
Number of assignments (max.):	760

### 4.2.3.1 Channel-independent objects

Function: Central function

Object	Function	Name	Type	DPT	Flag
 <sup>1</sup>	Switching	Central 1	1-bit	1,001	C, W, -, (R) <sup>1</sup>

Description 1-bit input object for central switching of assigned output channels. The polarity can be configured.

Function: Central function

Object	Function	Name	Type	DPT	Flag
 <sup>2</sup>	Switching	Central 2	1-bit	1,001	C, W, -, (R) <sup>1</sup>

Description 1-bit input object for central switching of assigned output channels. The polarity can be configured.

Function: Central function

Object	Function	Name	Type	DPT	Flag
 <sup>3</sup>	Switching	Central 3	1-bit	1,001	C, W, -, (R) <sup>1</sup>

Description 1-bit input object for central switching of assigned output channels. The polarity can be configured.

Function: Collective feedback status

Object	Function	Name	Type	DPT	Flag
 <sup>4</sup>	Feedback switching status	Collective feedback	4 byte	27,001	C, -, (T), (R) <sup>2,3</sup>

Description 4-byte output object for collective status feedback of the switching states of dimming and switching channels. The collective feedback summarises the switching status in just one telegram. The object contains bit-orientated feedback information. The object can be actively transmitting or passively read out (parameter-dependent).

1: For reading, the R-flag must be set. The last value written to the object via the bus will be read.

2: The communication flags are set automatically depending on the configuration. "T" flag for active signalling object; "R" flag for passive status object.

3: For reading, the R-flag must be set. The last value written to the object by the device will be read out.

Function: Operating hours counter, relay outputs					
Object	Function	Name	Type	DPT	Flag
 17, 41, 65, 89, 113, 137, 161	Limiting value / starting value, operating hours counter <sup>1</sup>	Switching channel 1...4	2 byte	7,007	C, W, -, (R) 2
Description      2-byte input object for external specification of a limit value / starting value of the operating hours counter of a relay output. <sup>3</sup> Value range: 0... 65535 hours					

Function: Operating hours counter, relay outputs					
Object	Function	Name	Type	DPT	Flag
 18, 42, 66, 90, 114, 138, 162	Restart op. hours counter	Switching channel 1...4	1-bit	1,015	C, W, -, (R) 4
Description      1-bit input object for resetting the operating hours counter of a relay output ("1" = Restart, "0" = No reaction). <sup>3</sup>					

Function: Operating hours counter, relay outputs					
Object	Function	Name	Type	DPT	Flag
 19, 43, 67, 91, 115, 139, 163	Value operating hours counter	Switching channel 1...4	2 byte	7,007	C, -, T, (R) 5
Description      2-byte output object to transmit or read out the current meter reading of the operating hours counter of a relay output. If the bus voltage should fail, the value of the communication object is not lost and is actively transmitted to the bus after bus voltage return or an ETS programming operation. In the as-delivered state, the value is "0". <sup>3</sup>					

1: Threshold value object or start value object depending on the configured counter type of the operating hours counter.

2: For reading, the R-flag must be set. The last value written to the object via the bus will be read.

3: The operating hours counters are available for each dimming channel and also for the independent switching channels. Accordingly, the object numbers change, depending on the configuration.

4: For reading, the R-flag must be set. The last value written to the object via the bus or by the device will be read.

5: For reading, the R-flag must be set. The last value written to the object by the device will be read out.

Function: Operating hours counter, relay outputs

Object	Function	Name	Type	DPT	Flag
<input type="checkbox"/> ← 20, 44, 68, 92, 116, 140, 164	Op. hours counter elapsed	Switching channel 1...4	1-bit	1,002	C, -, T, (R) 1

Description      1-bit output object to signal that the operating hours counter has elapsed (forwards counter = limiting value reached / backwards counter = value "0" reached). With a message, the object value is actively transmitted to the bus ("1" = message active / "0" = message inactive).  
If the bus voltage should fail, the value of the communication object is not lost and is actively transmitted to the bus after bus voltage return or an ETS programming operation. <sup>2</sup>

1: For reading, the R-flag must be set. The last value written to the object by the device will be read out.

2: The operating hours counters are available for each dimming channel and also for the independent switching channels. Accordingly, the object numbers change, depending on the configuration.

## 4.2.3.2 Objects of the dimming channels

Function:		Dimming channel, switching				
Object	Function	Name	Type	DPT	Flag	
 5, 29, 53, 77	Switching	Dimming channel 1...4	1-bit	1,001	C, W, -, (R) <sub>1</sub>	
Description		1-bit input object for switching the dimming channel on or off ("1" = switch on; "0" = switch off).				

Function:		Dimming channel, switching feedback				
Object	Function	Name	Type	DPT	Flag	
 6, 30, 54, 78	Switching feedback	Dimming channel 1...4	1-bit	1,001	C, -, (T), (R) <sub>2,3</sub>	
Description		<p>1-bit output object for giving feedback on the individual switching state of a dimming channel ("1" = Switched on / "0" = Switched off). This object is only visible with the name "Switching feedback" when a dimming channel independently affects one relay output. It then feeds back the individual switching state of the individual dimming channel.</p> <p>If, depending on the configuration, multiple dimming channels affect a relay output, then the objects with the numbers 6, 30, 54, 78 feed back the <u>shared</u> relay status (see following object), which no longer feeds back the switching state of only one dimming channel. In this case, the individual switching state of just one dimming channel can be fed back via the objects 24, 48, 72, 96.</p>				

Function:		Dimming channel, switching feedback				
Object	Function	Name	Type	DPT	Flag	
 6, 30, 54, 78	Feedback of shared relay status	Dimming channel 1...4	1-bit	1,001	C, -, (T), (R) <sub>2,3</sub>	
Description		<p>1-bit output object for feedback of the shared switching status of linked dimming channels ("1" = Relay closed / "0" = Relay open). This object is only visible with the name "Feedback of shared relay status" when multiple dimming channels affect one relay output. It only feeds back the shared switching status of all the assigned dimming channels, and thus the relay status.</p> <p>In this case, the individual switching state of just one dimming channel can be fed back via the objects 24, 48, 72, 96.</p>				

Function:		Dimming channel, logic operation function				
Object	Function	Name	Type	DPT	Flag	
 7, 31, 55, 79	Logic operation	Dimming channel 1...4	1-bit	1,002	C, W, -, (R) <sub>1</sub>	
Description		1-bit input object as the input of the logic operation of a dimming channel. After bus voltage return or after programming with the ETS, the object value can be predefined for each parameter.				

1: For reading, the R-flag must be set. The last value written to the object via the bus will be read.

2: The communication flags are set automatically depending on the configuration. "T" flag for active signalling object; "R" flag for passive status object.

3: For reading, the R-flag must be set. The last value written to the object by the device will be read out.

---

Function: Dimming channel, relative dimming

Object	Function	Name	Type	DPT	Flag
 8, 32, 56, 80	Dimming	Dimming channel 1...4	4-bit	3,007	C, W, -, (R) 1

Description 4-bit input object for relative dimming of a dimming channel.

---

Function: Dimming channel, absolute dimming

Object	Function	Name	Type	DPT	Flag
 9, 33, 57, 81	Brightness value	Dimming channel 1...4	1 byte	5,001	C, W, -, (R) 1

Description 1-byte input object for predefining an absolute dimming value (brightness value 0...255 corresponding 0...100 %).

---

Function: Dimming channel feedback, absolute dimming (brightness value)

Object	Function	Name	Type	DPT	Flag
 10, 34, 58, 82	Feedback brightness value	Dimming channel 1...4	1 byte	5,001	C, -, T, (R) 2,

Description 1-byte output object for feedback signalling of an individually set dimming value (brightness value 0...255, corresponds to 0...100 %).

---

Function: Dimming channel, scene function

Object	Function	Name	Type	DPT	Flag
 11, 35, 59, 83	Scene extension	Dimming channel 1...4	1 byte	18,001	C, W, -, (R) 1

Description 1-byte input object for polling or saving a scene.

---

Function: Dimming channel, scene function

Object	Function	Name	Type	DPT	Flag
 12, 36, 60, 84	Extended scene recall	Dimming channel 1...4	1-bit	1,001	C, W, -, (R) 1

Description 1-bit input object for extended scene recall. Each ON telegram received recalls the next scene number of a dimming channel in sequence. Each OFF telegram received recalls the previous scene number. After a reset (bus voltage return, ETS programming number), an ON or OFF telegram always recalls scene number 1 first.

1: For reading, the R-flag must be set. The last value written to the object via the bus will be read.

2: The communication flags are set automatically depending on the configuration. "T" flag for active signalling object; "R" flag for passive status object.

3: For reading, the R-flag must be set. The last value written to the object by the device will be read out.

---

Function:	Dimming channel, disabling function				
Object	Function	Name	Type	DPT	Flag
 13, 37, 61, 85	Disabling	Dimming channel 1...4	1-bit	1,003	C, W, -, (R) 1

Description      1-bit input object for disabling a dimming channel (polarity configurable).

---

Function:	Dimming channel, forced position function				
Object	Function	Name	Type	DPT	Flag
 14, 38, 62, 86	Forced position	Dimming channel 1...4	2-bit	2,001	C, W, -, (R) 1

Description      2-bit input object for the forced position of a dimming channel. The polarity is fixed by the telegram.

---

Function:	Dimming channel, staircase function				
Object	Function	Name	Type	DPT	Flag
 15, 39, 63, 87	Staircase function start / stop	Dimming channel 1...4	1-bit	1,010	C, W, -, (R) 1

Description      1-bit input object to activate or deactivate the switch-on time of the staircase function of a dimming channel ("1" = switch-on / "0" = switch-off).

---

Function:	Dimming channel, staircase function				
Object	Function	Name	Type	DPT	Flag
 16, 40, 64, 88	Staircase time factor	Dimming channel 1...4	1 byte	5,010	C, W, -, (R) 1

Description      1-byte input object to specify a time factor for the switch-on time of the staircase function (value range: 0... 255).

---

Function:	Dimming channel, burn-in function				
Object	Function	Name	Type	DPT	Flag
 21, 45, 69, 93	Burn-in function, start/stop	Dimming channel 1...4	1-bit	1,010	C, W, -, (R) 1

Description      1-bit input object to start and stop the burn-in function of a dimming channel ("1" = Start / "0" = Stop). This object is only visible if the burn-in function provides starting and stopping via the KNX.

1: For reading, the R-flag must be set. The last value written to the object via the bus will be read.

---

Function:	Dimming channel, burn-in function				
Object	Function	Name	Type	DPT	Flag
 22, 46, 70, 94	Burn-in function duration	Dimming channel 1...4	1 byte	5,010	C, -, T, (R) 1,2
Description	1-byte output object for feeding back the burn-in time remaining or already elapsed in hours (configurable).				

---

Function:	Dimming channel, burn-in function				
Object	Function	Name	Type	DPT	Flag
 23, 47, 71, 95	Burn-in function pause	Dimming channel 1...4	1-bit	1,002	C, W, -, (R) 3
Description	1-bit input object for temporary pausing of a started burn-in period ("1" = Pause active / "0" = Pause removed). This object is only visible if the burn-in function provides pausing via the KNX.				

---

Function:	Dimming channel, switching feedback				
Object	Function	Name	Type	DPT	Flag
 24, 48, 72, 96	Switching feedback	Dimming channel 1...4	1-bit	1,001	C, -, (T), (R) 1,2
Description	<p>1-bit output object for giving feedback on the individual switching state of a dimming channel ("1" = Switched on / "0" = Switched off). This object is only visible when multiple dimming channels affect one relay output, depending on the configuration. It only feeds back the individual switching state of the individual dimming channel (not necessarily the actual switching state of the relay).</p> <p>If multiple dimming channels affect a relay output, then the objects with the numbers 6, 30, 54, 78 feed back the <u>shared</u> relay status, which no longer feeds back the switching state of only one dimming channel.</p>				

1: The communication flags are set automatically depending on the configuration. "T" flag for active signalling object; "R" flag for passive status object.

2: For reading, the R-flag must be set. The last value written to the object by the device will be read out.

3: For reading, the R-flag must be set. The last value written to the object via the bus will be read.

## 4.2.3.3 Objects of the independent switching channels (optional)

Function: Switching channel, switching					
Object	Function	Name	Type	DPT	Flag
 101, 125, 149	Switching	Switching channel 2...4	1-bit	1,001	C, W, -, (R) 1
Description: 1-bit input object to activate a switching output ("1" = Switch on / "0" = Switch off; "NO contact" or "NC contact" operating mode can be configured).					

Function: Switching channel, switching feedback					
Object	Function	Name	Type	DPT	Flag
 102, 126, 150	Switching feedback	Switching channel 2...4	1-bit	1,001	C, -, (T), (R) <sup>2,3</sup>
Description: 1-bit output object for giving feedback on the switching state of an independent switching channel ("1" = Switched on / "0" = Switched off). Depending on the configured relay operating mode, the feedback value should be interpreted differently: NO contact operating mode: Feedback = "0" -> Relay open, feedback = "1" -> Relay closed NC contact operating mode: Feedback = "0" -> Relay closed, feedback = "1" -> Relay opened					

Function: Switching channel, logic operation function					
Object	Function	Name	Type	DPT	Flag
 103, 127, 151	Logic operation	Switching channel 2...4	1-bit	1,002	C, W, -, (R) 1
Description: 1-bit input object as the input of the logical operation of a switching channel. After bus voltage return or after programming with the ETS, the object value can be predefined for each parameter.					

Function: Switching channel, scene function					
Object	Function	Name	Type	DPT	Flag
 107, 131, 155	Scene extension	Switching channel 2...4	1 byte	18,001	C, W, -, (R) 1
Description: 1-byte input object for polling or saving a scene.					

1: For reading, the R-flag must be set. The last value written to the object via the bus will be read.

2: The communication flags are set automatically depending on the configuration. "T" flag for active signalling object; "R" flag for passive status object.

3: For reading, the R-flag must be set. The last value written to the object by the device will be read out.



---

Function: Switching channel, scene function

Object	Function	Name	Type	DPT	Flag
 108, 132, 156	Extended scene recall	Switching channel 2...4	1-bit	1,001	C, W, -, (R) 1

Description 1-bit input object for extended scene recall. Each ON telegram received recalls the next scene number of a switching channel in sequence. Each OFF telegram received recalls the previous scene number. After a reset (bus voltage return, ETS programming number), an ON or OFF telegram always recalls scene number 1 first.

---

Function: Switching channel, disabling function

Object	Function	Name	Type	DPT	Flag
 109, 133, 157	Disabling	Switching channel 2...4	1-bit	1,003	C, W, -, (R) 1

Description 1-bit input object for disabling a switching channel (polarity configurable).

---

Function: Switching channel, forced position function

Object	Function	Name	Type	DPT	Flag
 110, 134, 158	Forced position	Switching channel 2...4	2-bit	2,001	C, W, -, (R) 1

Description 2-bit input object for the forced position of a switching channel. The polarity is fixed by the telegram.

---

Function: Switching channel, staircase function

Object	Function	Name	Type	DPT	Flag
 111, 135, 159	Staircase function start / stop	Switching channel 2...4	1-bit	1,010	C, W, -, (R) 1

Description 1-bit input object to activate or deactivate the switch-on time of the staircase function of a switching channel ("1" = switch-on / "0" = switch-off).

---

Function: Switching channel, staircase function

Object	Function	Name	Type	DPT	Flag
 112, 136, 160	Staircase time factor	Switching channel 2...4	1 byte	5,010	C, W, -, (R) 1

Description 1-byte input object to specify a time factor for the switch-on time of the staircase function (value range: 0... 255).

1: For reading, the R-flag must be set. The last value written to the object via the bus will be read.

## 4.2.4 Functional description

### 4.2.4.1 Description of channel-independent functions

#### 4.2.4.1.1 Configuration of the inputs and outputs

##### Functional description

In the ETS application program of the control unit, 5 device configurations can be selected, causing the allocation of the 4 individually-activatable dimming channels to the switching outputs. This means that, optionally, 1-10 V dimming channels can be combined to execute a shared switching action, in order to implement different control tasks (e.g. 4 dimming channels act on a switching relay to activate an RGBW luminaire or 4 dimming channels act in pairs, each on one relay, to separate two load circuits). Relay outputs not allocated to any dimming channel can be used as freely acting switching actuator channels.

The configuration is specified in the ETS under the parameter page "Configuration of inputs / outputs".

##### Configuration 1

The parameter "Assignment of dimming channels to the outputs" is set to "4 separate switching/dimming channels". In this configuration, the control unit is used classically. The 1-10 V inputs (E1...E4) are each assigned independently to the switching outputs (A1...A4).

The feedback for the switching status and brightness values exist separately and can be evaluated.

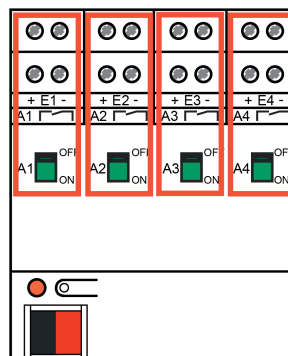

Figure 4: Configuration 1 - Classic application / inputs have a separate effect on the outputs

##### Configuration 2

The parameter "Assignment of dimming channels to the outputs" is set to "4 dimming channels with 1 switching channel + 3 switching channels". This configuration is suitable, for example, for activating RGBW luminaires. Four 1-10 V inputs (E1...E4) are activated separately. An assigned switching output (A1) switches the load.

Three further switching outputs (A2, A3, A4) can also be used independently. The four 1-10 V inputs can be activated separately, meaning that individual colour matching of the RGBW luminaire can be achieved.

To activate the relay of output 1, the control unit combines the 4 logical switching states of all the dimming channels internally (OR link). However, the 4 dimming channels work independently. In consequence, the dimming channels possess individual feedback objects for the switching status and brightness values (e.g. to feed back the switching states of the individual colours). In addition, there is an additional 1-bit object for each dimming channel, allowing feedback of the shared relay status of all the dimming channels, i.e. the switching state of output 1.

The feedback of the switching status of the independent switching channels A2...A4 exist separately and can be evaluated.

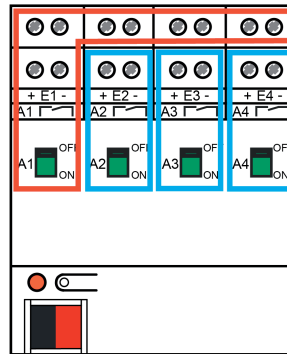

Figure 5: Configuration 2 - All 4 inputs affect output 1 / Outputs 2...4 can be used independently

### Configuration 3

The parameter "Assignment of dimming channels to the outputs" is set to "2 dimming channels with 1 switching channel + 2 switching/dimming channels + 1 switching channel". This setting provides two dimming channels (E1, E2), which jointly affect a switching output (A1). Two further 1-10 V inputs (E3, E4) each affect one switching output (A3, A4) and can be used independently.

One switching output (A2) can be activated separately.

Application of this configuration, e.g. in an open-plan office with 2 additional rooms.

To activate the relay of output 1, the control unit combines the logical switching states of the dimming channels E1 and E2 internally (OR logical operation). However, these two dimming channels work independently. In consequence, these dimming channels possess individual feedback objects for the switching status and brightness values (e.g. to feedback the switching states of the individual colours). In addition, there is an additional 1-bit object for the dimming channels E1 and E2, allowing feedback of the shared relay status of these dimming channels, i.e. the switching state of output 1.

This differs for the dimming channels E3 and E4. These channels work separately and independently of one another and thus possess their own switching status and brightness value feedback.

The feedback of the switching status of the independent switching channel A2 is available separately.

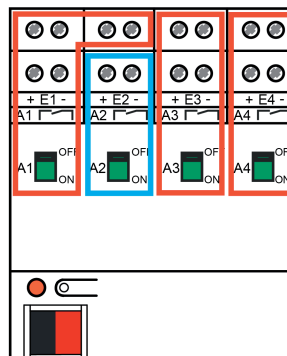

Figure 6: Configuration 3 - Inputs 1 & 2 affect output 1 / inputs 3 & 4 affect outputs 3 & 4 separately / output 2 can be used independently

## Configuration 4

The parameter "Assignment of dimming channels to the outputs" is set to "2 pairs of dimming channels each with 1 switching channel + 2 switching channels". Two dimming channels each (E1, E2 + E3, E4) affect one switching output (A1, A3) separately. Two switching outputs (A2, A4) can be activated separately.

Application of this configuration, e.g. in a seminar room with 2 or 4-channel dimmer control in up to two load circuits.

To activate the relay of outputs 1 and 3, the control unit separately combines the 2 logical switching states of the dimming channels E1 & E2 and E3 & E4 internally (OR logical operation). However, the dimming channels work independently. In consequence, the dimming channels possess individual feedback objects for the switching status and brightness values (e.g. to feed back the switching states of the individual colours). In addition, there is an additional 1-bit object for each dimming channel pair, allowing feedback of the shared relay status of the pairs, i.e. the switching states of output 1 and 3.

The feedback of the switching status of the independent switching channels A2 and A4 exists separately and can be evaluated.

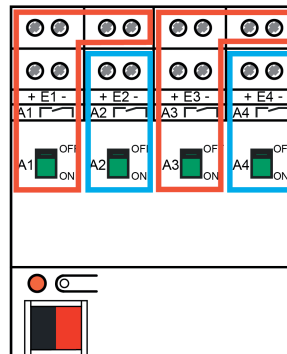

Figure 7: Configuration 4 - Inputs 1 & 2 affect output 1 /  
Inputs 3 & 4 affect output 3 /  
Outputs 2 and 4 can be used independently

## Configuration 5

The parameter "Assignment of dimming channels to the outputs" is set to "3 dimming channels with 1 switching channel + 1 switching/dimming channel + 2 switching channels". This configuration is suitable, for example, for activating RGB luminaires and an additional dimmable lighting device. Three 1-10 V inputs (E1...E3) are activated separately. An assigned switching output (A1) switches the load.

A further 1-10 V input (E4) affects another switching unit (A4). This switching/dimming channel can be used independently.

In addition, two switching outputs (A2, A3) can be activated separately.

The first three 1-10 V inputs can be activated separately, meaning that individual colour matching of the RGB luminaire can be achieved.

To activate the relay of output 1, the control unit combines the logical switching states of the dimming channels E1, E2 and E3 internally (OR logical operation). However, these three dimming channels work independently. In consequence, these dimming channels possess individual feedback objects for the switching status and brightness values (e.g. to feedback the switching states of the individual colours). In addition, there is an additional 1-bit object for the dimming channels E1, E2 and E3, allowing feedback of the shared relay status of these dimming channels, i.e. the switching state of output 1.

Dimming channel E4 works separately and independently of one another and thus possesses its own switching status and brightness value feedback.

The feedback of the switching status of the independent switching channels A2 and A3 exist separately and can be evaluated.

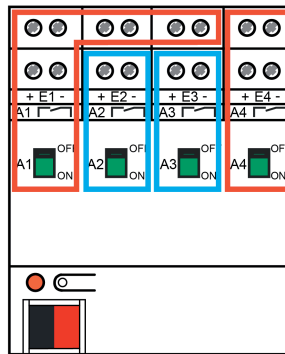

Figure 8: Configuration 5 - Inputs 1...3 affect output 1 / Input 4 affects output 4 / Outputs 2 and 3 can be used independently

## 4.2.4.1.2 Delay after device reset

### Functional description

To reduce telegram traffic on the KNX line after bus voltage switch-on (bus reset), after connection of the device to the KNX line or after programming with the ETS, it is possible to delay various actively transmitting feedback telegrams of the actuator. For this purpose, a channel-independent delay can be specified (parameter "Delay after bus voltage return" on parameter page "General"). Only after the configured time elapses are delayed feedback telegrams for initialisation transmitted to the bus.

It is possible to configure separately which of the feedback telegrams are actually delayed for each dimming channel and also for the independent switching channels for actively transmitting feedback of the switching states and brightness values. A delay can also be configured for the collective feedback.

- i** The delay has no effect on the behaviour of an individual channel. Only the feedback telegrams are delayed. The channels can also be activated during the delay after bus voltage return.
- i** A setting of "0 minutes, 0 seconds" for the delay after bus voltage return deactivates the delaying function altogether. In this case, feedback, if actively transmitting, and the assigned delay are indeed transmitted to the bus without any delay after a device reset.
- i** The actively transmitting objects of the operating hours counter always transmit the status without any delay after a device reset. The feedback objects of the burn-in functions (only available for dimming channels) always transmit the status with a delay after a reset.

### Delaying a feedback

Only channel-orientated feedback of the switching states and brightness values can be influenced with regard to the transmitting behaviour after bus voltage return. In the same way, the object of the collective feedback can be delayed as necessary.

Precondition:

The feedback functions must be configured to actively transmitting.

- Set the parameter "Time delay for feedback telegram after bus voltage return" to "Yes". The parameter is located on the parameter page of the corresponding switching status or brightness value feedback of a dimming channel or the parameter page of the appropriate switching status feedback of an independent switching channel.
- Optionally, set the parameter "Time delay for feedback telegram after bus voltage return" for the collective feedback to "Yes" on the "General" parameter page.

If there is an active delay, after bus voltage return the feedback telegram is first transmitted to the bus after the end of the delay time. Alternatively ("No" setting), a feedback telegram is transmitted to the bus without delay immediately after bus voltage return.

## 4.2.4.1.3 Central function

### Functional description

The actuator offers the possibility of linking selected individual or all dimming channels, as well as the independent switching channels, with up to three central 1-bit communication objects. The behaviour in case of activating a channel via the central function is comparable to a central group address linked with all "Switching" input objects.

The channels assigned to the central functions are activated in accordance with the received object value. The polarity of the up to three central telegrams can be configured independently.

The behaviour of the channels on the reception of central telegrams is identical with the normal control via the "Switch" objects. (same priority – each last switching command is executed).

Thus, all downstream functions, such as timing/supplementary functions, are also taken into account.

### Enabling the central function

- Activate the up to three central functions on parameter page "General" by setting the "Use central function x ?" (x = 1...3) with the "Yes" setting.
- Configure the polarity of the enabled central communication objects.  
If the functions are enabled, the associated "Central switching" communication objects become visible.

### Assign channels to the central functions

Each dimming channel and also the independent switching channels can be assigned to the up to three central functions, independently of one another.

Precondition:

The central functions must have been enabled on parameter page "General". Otherwise, no assignment is possible.

- Set the Parameter "Assignment to central function x?" (x = 1...3) on the "Ex - General" or "Ax - General" parameter page to "Yes".

The channel is assigned to the central functions according to the selection. The connected loads can be switched on or off centrally.

- i** The switching state set by the central functions is not tracked in the feedback objects. The switching state set by a central function is not tracked in the "switching" objects.
- i** Switching channels assigned to dimming channels according to the configuration do not behave independently and thus cannot be separately assigned to a central function. In this case, there is central relay activation via the central function of the assigned dimming channels.
- i** After a bus voltage return or after programming with the ETS, the central function is always inactive (object value "0").

## 4.2.4.1.4 Collective feedback

### Functional description

After central commands or after bus voltage return, a KNX line is generally heavily loaded by data traffic as many bus devices are actively transmitting the state of their communication objects by means of feedback telegrams. This effect occurs particularly when using visualisations. Collective feedback for switching states can be used to keep the telegram load low during initialisation.

The collective feedback summarises the switching states of all the dimming channels and also of the independent switching channels in just one telegram. The 32-bit communication object "Collective feedback" contains bit-orientated feedback information of the individual channels.

The datapoint type of the collective feedback corresponds to the KNX standard (DPT 27.001). The application would be possible in appropriate visualisation applications - for example in public buildings such as schools or hospitals - where the switching states of the actuators are displayed centrally and no status is displayed at the control sections. In such applications the collective feedback can replace the 1 bit individual feedbacks and thereby significantly reduce the KNX bus load.

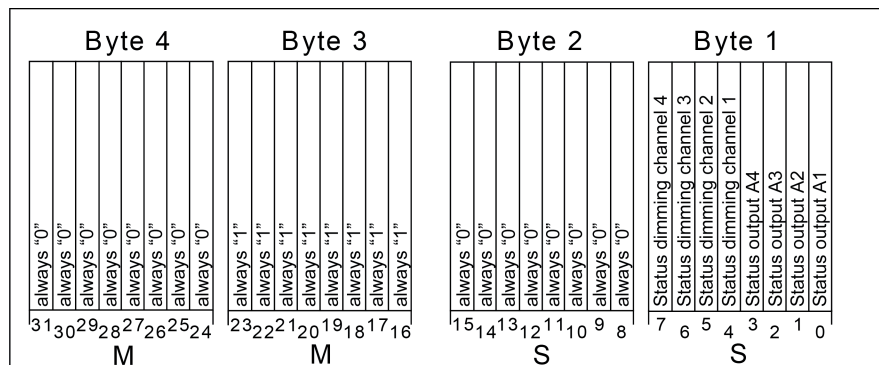

Figure 9: Object structure of the collective feedback

The collective feedback of the control unit displays up to 8 different switching stati. In so doing, each item of status information possesses one bit, which directly represents the switching state ("S" bit), and another bit defining the masking ("M" bit). The "S" bits correspond to the logical non-inverted switching states of the dimming channels and the independent switching channels and are either "1" (switched on) or "0" (switched off). The "M" bits stand for a "1" status information, if an appropriate "S" bit is available in the object value. The "M" bits are "0" if the appropriate "S" bit is not used in the feedback. Then, the corresponding "S" bits are continuously "0", as there is no switching status.

As an item of status information is always displayed in the "S" bits 0...7 in the control unit, the appropriate "M" bits 16...23 are also always "1" (Figure 9). The "M" bits 24...31 are always "0" because the "S" bits 8...15 are not used.

The "S" bits 0...3 immediately display the switching status of the outputs A1...A4. Depending on the configuration set in the ETS, this status is either defined by the assignment of just an individual dimming channel, by a combination of multiple dimming channels (OR logical operation) or by an independent switching channel.

Examples:

1. The dimming channels E1...E4 jointly affect the switching output A1.  
-> Bit 0 displays the shared switching state of all the dimming channels and thus the state of the relay of output 1. Bits 1...3 signal the independent switching states of the independent switching channels.

2. The dimming channels E1 and E2 jointly affect the switching output A1. Switching output A2 acts independently. Dimming channels E3 and E4 each act individually on the switching outputs A3 and A4.



-> Bit 0 shows the combined switching state of the dimming channels E1 and E2 and thus the state of the relay of output 1. Bit 1 signals the switching state of the independent switching channel A2. Bit 2 displays the individual switching state of dimming channel E3 and Bit 3 displays the switching state of dimming channel E4.

- i** In the case of independent switching channels, the bits always display the non-inverted switching status of the channel. The switching state of the relay can be determined from the combination of switching status and configured relay operating mode (NO or NC contact):  
NO contact operating mode: Status = "0" -> Relay open, status = "1" -> Relay closed  
NC contact operating mode: Status = "0" -> Relay closed, status = "1" -> Relay open

The "S" bits 4...7 always display the individual switching state of a dimming channel. A logical operation of other switching states or the actual relay status are irrelevant here.

- i** A "flashing" output (see "Disabling function") is always reported as "switched on".

### **Activate collective feedback and configure the feedback type**

The collective feedback can be used as an active message object or as a passive status object. As an active message object, the collective feedback is transmitted to the bus whenever a switching state changes or is updated (depending on the parameter "Update of the object value for collective feedback"). In the function as a passive status object, there is no automatic telegram transmission. In this case, the object value must be read out. The ETS automatically sets the object communication flags required for proper functioning.

- Set the parameter "Collective feedback switching status?" on the parameter page "General" to "yes".  
Collective feedback is enabled. The communication object and others parameters become visible.
- Set the parameter "Type of collective feedback" to "Active signalling object".  
The collective feedback is transmitted once the status is updated. An automatic telegram transmission of the feedback takes place after bus voltage return or after programming with the ETS.
- Set the parameter to "Passive status object".  
The collective feedback will be transmitted in response only if the feedback object is read out from by the bus. No automatic telegram transmission of the feedback takes place after bus voltage return or after programming with the ETS.

### **Setting the update of collective feedback**

In the ETS, you can specify when the actuator should update the feedback value for the collective feedback in case of an actively transmitting communication object. The object value updated by the actuator is then signalled actively to the bus.

Precondition:

Collective feedback must be enabled. In addition, the feedback must be configured to actively transmitting.

- Set the parameter "Update of the object value for collective feedback" to "On each update obj. 'Switching'/'Central'".

The actuator updates the feedback value in the object once a new telegram is received on the input objects "Switching" or "Central switching" or the switching state changes internally (e.g. through a time function). A new telegram is also then actively transmitted to the bus each time. The telegram value of the feedback does not necessarily have to change in the process. Hence, corresponding collective feedback is also generated on a switching object such as in the case of cyclical telegrams, for example.

- Set the parameter to "Only if the feedback value changes".

The actuator only updates the feedback value in the object if the telegram value (e.g. "OFF" to "ON") also changes or the switching state changes internally (e.g. through a time function). If the telegram value of the feedback does not change (e.g. in the case of cyclical telegrams to the "Switching" object with the same telegram value), the actuator does not transmit any feedback. Consequently, with an actively transmitting feedback object, no telegram with the same content will be transmitted repeatedly either.

## Activating collective feedback on return of bus voltage or after programming with the ETS

If used as active message object, the collective feedback is transmitted to the bus after bus voltage return or after programming with the ETS. In these cases, the feedback telegram can be time-delayed with the delay being preset globally (see "Delay after bus voltage return").

Precondition:

Collective feedback must be enabled. In addition, the feedback must be configured to actively transmitting.

- Set the parameter "Time delay for feedback telegram after bus voltage return" of the collective feedback to "yes".

The collective feedback telegram is transmitted with a delay after bus voltage return or after programming in ETS. No feedback telegram is transmitted during a running delay, even if a switching state changes during this delay.

- Set the parameter "Time delay for feedback telegram after bus voltage return" of the collective feedback to "no".

The collective feedback telegram is transmitted immediately after bus voltage return or ETS programming.

## Setting cyclic transmission of the collective feedback

The telegram of the collective feedback can also be transmitted cyclically, in addition to transmission on a change or update.

Precondition:

Collective feedback must be enabled. In addition, the feedback must be configured to actively transmitting.

- Set the parameter "Cyclic transmission of the collective feedback ?" to "yes".

Cyclical transmission is activated. The collective feedback is transmitted to the bus cyclically and if one of the switching states changes or is updated.

- Set the parameter "Cyclic transmission of the collective feedback ?" to "no".

Cyclical transmission is deactivated, which means that the collective feedback is only transmitted to the bus if one of the switching states changes or is updated.

- i** The cycle time for all cyclic feedback telegrams is defined centrally on the "Times" parameter page.

- i** During an active delay after bus voltage return, no collective feedback will be transmitted even if a switching state changes.

## 4.2.4.2 Functional description of the dimming channels

### 4.2.4.2.1 Function diagram and priorities

#### Function diagram

With the dimming channels, various functions can be combined. Some functions are always available (e.g. switching and dimming, reset behaviour). Other functions can be optionally added to a dimming channel (e.g. disabling function, staircase function). Processing of the channel functions takes place according to a specific sequence. This means that the functions influence each other.

The function diagram shows in which order the functions of a dimming channel are processed (Figure 10).

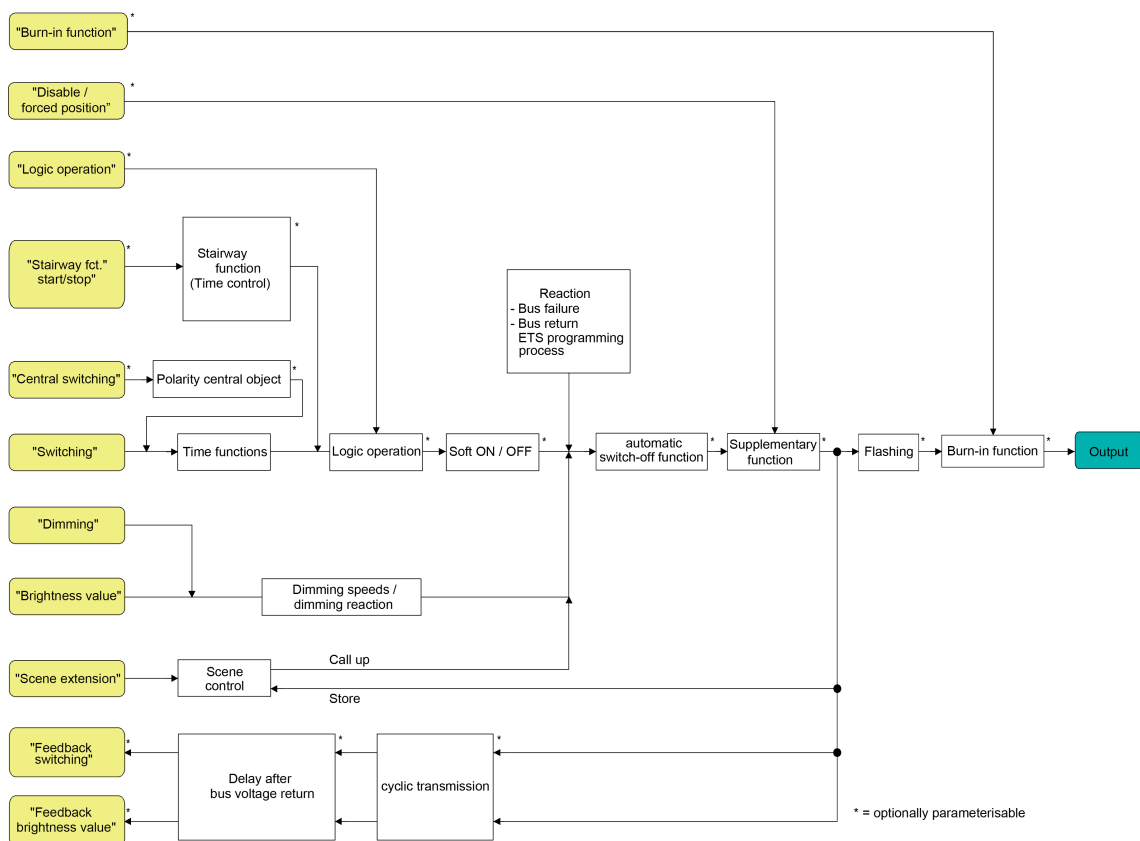

Figure 10: Function diagram of the dimming channels

#### Priorities

Functions with a higher priority override other functions with a lower priority. In the same way as the function diagram, the descending function priorities of a dimming channel are specified as follows:

1. Safe-state mode (see page 16)
2. Burn-in function (see page 74)
3. Forced position / disabling function (see page 77)
4. Reset behaviour (see page 48)
5. Logical operation function / Staircase function (see page 61)
6. Normal operation (switching, dimming, brightness value scene / last command is performed)

## 4.2.4.2.2 Definition of the brightness range

### Functional description

The brightness range, adjustable by switching or dimming procedures, can be limited by defining a lower and upper brightness value. The lower brightness value is either defined by the basic brightness, or alternatively, by the minimum brightness. The upper brightness value is always characterised by the maximum brightness.

The maximum brightness adjustable in the ETS is never exceeded under any circumstances in the switched-on operating state of a dimming channel. Neither when switching on nor when dimming. The maximum brightness value can be reduced for energy saving reasons, for example.

Furthermore, the brightness value, which should be set whenever switching on via the "Switching" or "Central switching" object on the dimming channel, can be predefined. This switch-on brightness must always be between the upper and lower brightness limit value of the dimming range.

The adjustable characteristics of the lower brightness value in the ETS differ as follows...

- Definition of the lower brightness limit with basic brightness:  
The "Basic brightness" parameter on the parameter page "Ex – General" predefines the lower brightness threshold by adapting to the luminaires.  
The basic brightness can be set to one of 8 step values and is a gauge for the minimum adjustable control voltage in relation to the decimal brightness values "1", "2" and "3" (percentage: ~0.4 ... 1.2 %). The basic brightness can be undershot only by switching off. The configurable basic brightness enables the dimming signal to be adjusted in the smallest possible dimming position of the luminaire used. The basic brightness should be set to a step value at which the lamp at the smallest brightness value will still light up at an adequate level of brightness so that it is detected as switched on.  
Depending on the configured level of the basic brightness, the smallest possible control voltage in the ON state is defined to various values (see following table).

Basic brightness level	Control voltage on OFF (Brightness value = "0")	Smallest control voltage on ON (Brightness values = "1, 2, 3")
1	0.8 V	0.8 V
2	0.8 V	1.2 V
3	0.8 V	1.8 V
4	0.8 V	2.4 V
5	0.8 V	3.0 V
6	0.8 V	3.6 V
7	0.8 V	4.2 V
8	0.8 V	4.8 V

Control voltage dependent on the configured basic brightness

- i** The basic brightness is always set for the decimal brightness values 1, 2 or 3 (smallest dimming position). The dimming increments of the brightness range 4...255 are assigned in linear form to the remaining control voltage range (control voltage increment basic brightness -> 10 V).

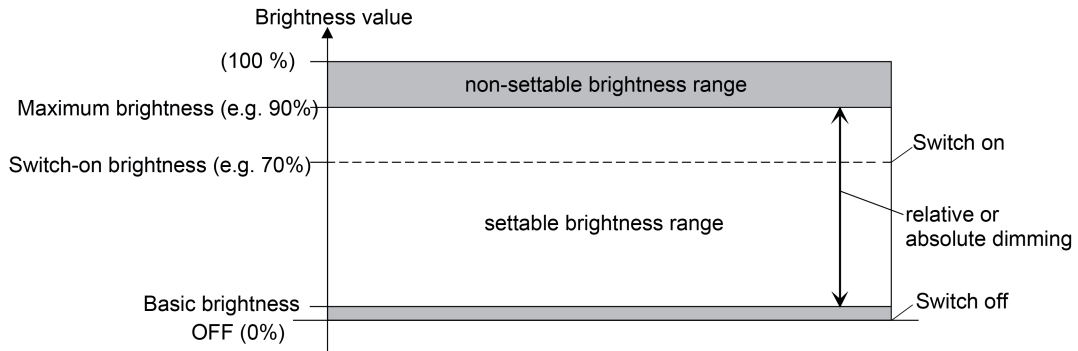

Figure 11: Example of a brightness range with basic brightness

**i** The 1-10 V inputs E1...E4 are current sinks, which - depending on the available constant current from the electronic ballasts - can continuously control the voltage between the terminals "+" and "-" in the range between 0.8 V (depending on the configured basic brightness) and 10 V. These inputs do not actively make any voltage available themselves (no integrated power supply unit). In the OFF state, the control voltage of 0.8 V is only set when the connected electronic ballasts are still connected to the mains voltage. If the electronic ballasts in the OFF state are disconnected from the mains voltage, an undefined voltage is set at the inputs.

- Definition of the lower brightness limit with minimum brightness:  
The "Minimum brightness" parameter of the parameter page "Ex – General" predefines a lower brightness threshold in the percentage range 1 % ... 45 % (decimal "3" ... "115") in stages. The minimum brightness cannot be undershot in any switched-on operating state of the dimming channel. An undershot is only possible by switching off.  
The brightness of the controlled lamps can be adapted individually – even to the brightness sensitivity of the human eye - by using the minimum brightness.

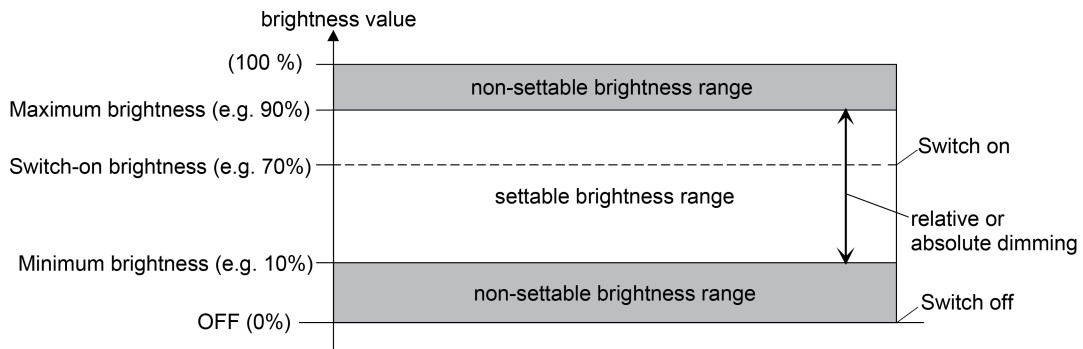

Figure 12: Example of a brightness range with minimum brightness

**i** At a minimum brightness of "1 %", a control voltage of approx. 0.8 V is set in the smallest dimming position.

### Adjusting basic brightness

The basic brightness can be set separately for each dimming channel.

Precondition:

The "Definition of the brightness range" parameter is configured to "with basic brightness".

- Set the "Basic brightness" parameter on parameter page "Ex - General" to the required step value.  
The set step value, which is a gauge for the smallest adjustable control value and is set to the decimal brightness values "1", "2" and "3", cannot therefore be undershot in any switched-on operating state of the dimming channel.
- ❗ The parameter should be set in such a way that the lamp will still light up at the lowest dimmer setting.

### Setting the minimum brightness

The minimum brightness can be set separately for each dimming channel.

Precondition:

The "Definition of the brightness range" parameter is configured to "with minimum brightness".

- Set the "Minimum brightness" parameter on parameter page "Ex - General" to the required brightness value.  
The set brightness is not undershot in any switched-on operating state.
- ❗ The selection of the adjustable value is upwardly limited to 45 %. Greater values cannot be configured because otherwise the adjustment range of the maximum brightness will be cut (minimum brightness < maximum brightness).
- ❗ The ETS does not check all configured brightness values of a channel during the editing of the minimum brightness (e.g. switch-on brightness, scene values)! If values that are smaller than the configured minimum brightness are predefined by the ETS configuration, the actuator sets the minimum brightness as brightness value later during operation. The same holds true if the actuator receives values via the brightness object during operation, which undershoots the minimum brightness.

### Setting the maximum brightness

The maximum brightness can be set separately for each dimming channel.

- Set the "Maximum brightness" parameter on parameter page "Ex - General" to the required brightness value.  
The set brightness is not undershot in any switched-on operating state of the dimming channel.
- ❗ The selection of the adjustable value is downwardly limited to 50 % when using a minimum brightness. Smaller values cannot be configured in this case because otherwise the adjustment range of the minimum brightness will be cut (minimum brightness < maximum brightness).
- ❗ The ETS does not check all configured brightness values of a channel during the editing of the maximum brightness (e.g. switch-on brightness, scene values)! If values that are greater than the configured maximum brightness are predefined by the ETS configuration, the actuator sets the maximum brightness as brightness value later during operation. The same holds true if the actuator receives values via the brightness object during operation, which exceed the maximum brightness.

### Setting the switch-on brightness

The switch-on brightness can be set separately for each dimming channel.

- Set the "Switch-on brightness" parameter on parameter page "Ex - General" to the required brightness value.

The set brightness is set after receipt of an ON telegram via the "Switching" communication object on the dimming channel. Furthermore, the configured switch-on brightness is set with the "activated" polarity after receipt of a central telegram.

- Alternatively, set the parameter "Switch-on brightness" to "Memory value (brightness before switching off last time)".

When switching on, the active and internally saved brightness value prior to switching off last time is set (via the "switching" or "central switching" object). After programming with the ETS, the value is predefined to maximum brightness. A bus voltage failure does not delete the memory value.

- i** If the configured switch-on brightness is greater than the configured maximum brightness, the actuator sets the maximum brightness as the new brightness value for the dimming channel concerned when switching on (minimum brightness < switch-on brightness < maximum brightness).
- i** A memory value is also then saved internally by a switch-off telegram if the bus-controlled switch-off is overridden, for example, by a disable or forced position function. In this case, the internally tracked brightness value is saved as memory value.
- i** If no soft ON function is activated, the brightness value is jumped to when switching on. Once a soft ON function is activated, the switch-on brightness is dimmed according to the dimming speed for the soft ON function.



## 4.2.4.2.3 Dimming characteristic, dimming behaviour and dimming speeds

### Relative and absolute dimming

A dimming procedure can change the brightness of the lamps connected to a dimming channel. The limits of the brightness range adjustable by a dimming procedure is defined either by the basic brightness and maximum brightness predefined in the ETS, or alternatively, by the combination of minimum brightness and maximum brightness.

A channel can be dimmed by...

- relative dimming:  
Relative dimming can be triggered by the 4-bit "Dimming" communication object available separately in each dimming channel. The data format of the "dimming" object complies with the KNX standard DPT "3.007", which means that the dimming direction and relative dimming increments can be predefined in the dimming telegram or dimming procedures can also be stopped. The dimming process ends when the basic/minimum brightness or maximum brightness is reached.
- absolute dimming:  
Absolute dimming is triggered by specifying a brightness value. This value can be predefined by the 1-byte "brightness value" communication object from KNX the, which is available separately in each dimming channel. In addition, brightness values can also be set by a disabling or forced position function or by the scene function. Absolute dimming can also be activated, even in case of bus voltage failure, after bus voltage return or after programming with the ETS, by specifying brightness values.  
When predefining a brightness value via the object or by a scene recall, it is possible to configure in the ETS whether the value is jumped to directly or alternatively whether it is dimmed to via the configured dimming increment time or by fading. In the case of all other absolute dimming functions, the brightness values are always instantly jumped to.

The dimming speed is identical for a relative dimming procedure or for the dimming of an absolute brightness value (not fading) and can be set in the ETS separately for each dimming channel in the characteristic parameters.

### Setting dimming increment time and characteristic curve

The dimming increment speed is identical for a relative dimming procedure or for the dimming of an absolute brightness value (not fading) and can be set in the ETS separately for each dimming channel in the characteristic parameters. If necessary, the linear characteristic curve can be adjusted according to the user's requirements by dividing the dimmable brightness range into up to 5 areas. Each brightness range can then be assigned an individual dimming increment speed.

User-defined characteristics allow the adjustment of brightness changes for time-controlled dimming operations. This means that - depending on the luminaire used - it is possible to adjust dimming operations to the brightness perception of the human eye.

#### Linear dimming characteristic:

- Set the parameter "Characteristic curve" on the parameter page "Ex - dimming characteristic" to "Linear".
- Set the parameter "Time between two dimming increments " to the necessary dimming increment time.

The dimming characteristic is linear. During every relative or absolute dimming procedure, the entire brightness range is dimmed with the configured dimming increment speed.

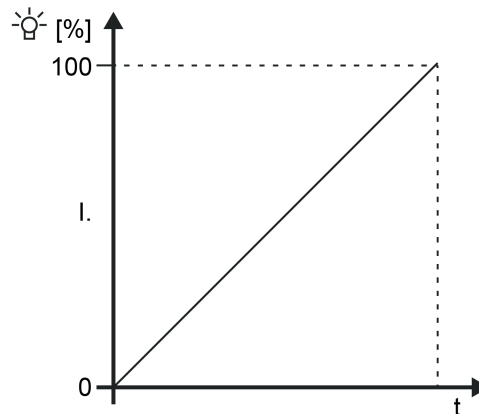

Figure 13: Linear dimming characteristic

#### User-defined dimming characteristic:

- Set the parameter "Characteristic curve" on the parameter page "Ex - dimming characteristic" to "Dim to...". Specify the number of required areas (2...5) (division of the dimmable brightness area), depending on the use requirement and the luminaire used.
- After this, define the brightness limiting values according to the number of areas. To do this, set the parameter "Brightness limiting value..." to the required subarea limits. In so doing, ensure that the brightness limiting values are defined in ascending order. It is not permissible to configure lower brightness values for higher limiting values than for lower limiting values.
- ⓘ In the configuration of the limiting value, care must be taken to ensure that the maximum brightness is not exceeded, or if necessary, the configured minimum brightness is not undershot. The dimmable range is between basic and maximum brightness or minimum and maximum brightness.
- Set the parameters "Time between two dimming increments" of the individual subareas to the necessary time.  
The dimming characteristic is defined. The lighting is dimmed at the specified dimming increment speeds for each of the sections.
- ⓘ The scene dimming increment speed for the dimming of scene values is defined separately in the scene parameters of an output.

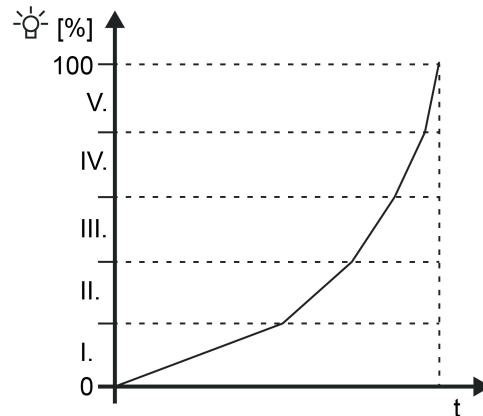

Figure 14: User-defined dimming characteristic (as an example with 5 brightness areas)

### Characteristic curve in the dimmable brightness range

In the control unit, the dimmable brightness range within the technical limits (basic brightness ... 100 %) is subdivided into 255 dimming increments (8-bit brightness value: 1...255 / 0 = switched off). In the as-delivered state of the actuator, the dimming increment times, i.e. the dimming times between 2 of 255 dimming increments, are set to the identical length. This results in a linear characteristic curve over the entire brightness range. The dimming characteristic can also be adjusted by the user, as necessary (see page 41).

The dimmable brightness range is limited at the upper limit by the maximum brightness configured in the ETS. The lower brightness range is either defined by the basic brightness (brightness values "1", "2" and "3" -> "1 %") or alternatively, by the minimum brightness. The dimming characteristics shown in the following diagrams distinguish these configurations and illustrate the resulting real dimming time of a dimming procedure.

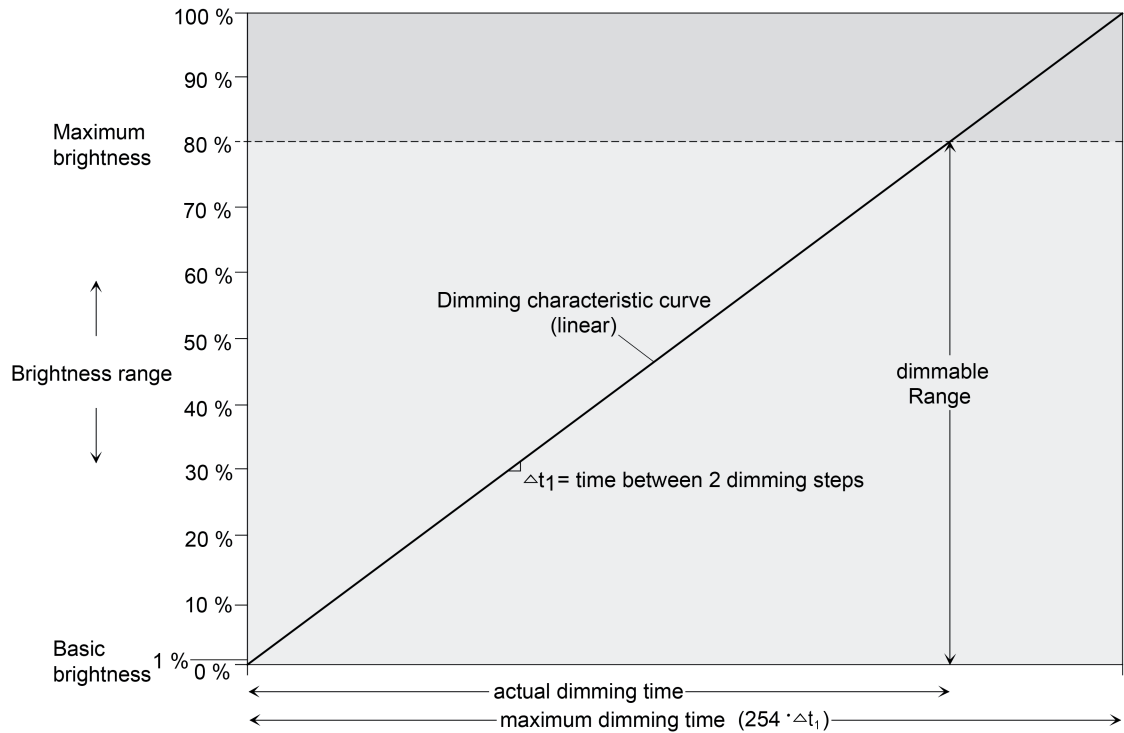

Figure 15: Linear dimming characteristic as an example with basic brightness and maximum brightness

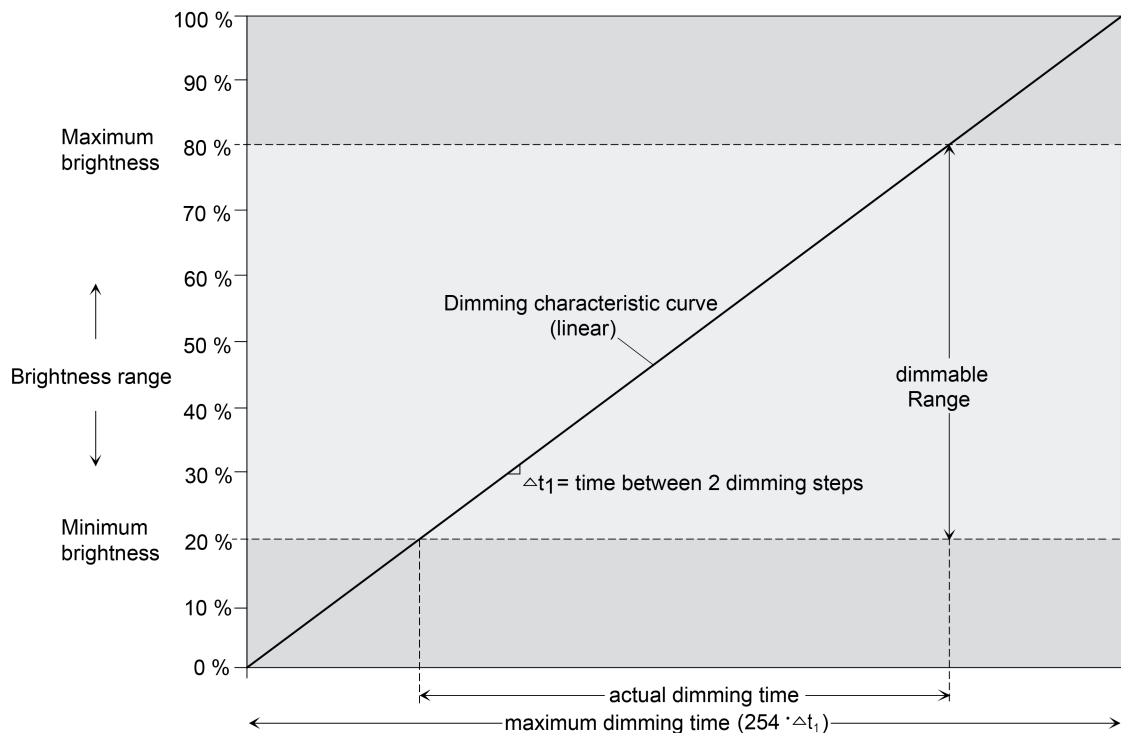

Figure 16: Linear characteristic dimming curve as an example with minimum brightness > 0 % and maximum brightness

In some practical applications, a linear dimming characteristic is not optimal. Hence, the actuator in the ETS alternatively permits a user-defined adjustment of the dimming progress. In this way, for example, brightness changes can be adjusted to the brightness sensitivity of the human eye when dimming by subdividing the brightness range in up to 5 sections with different dimming increment times.

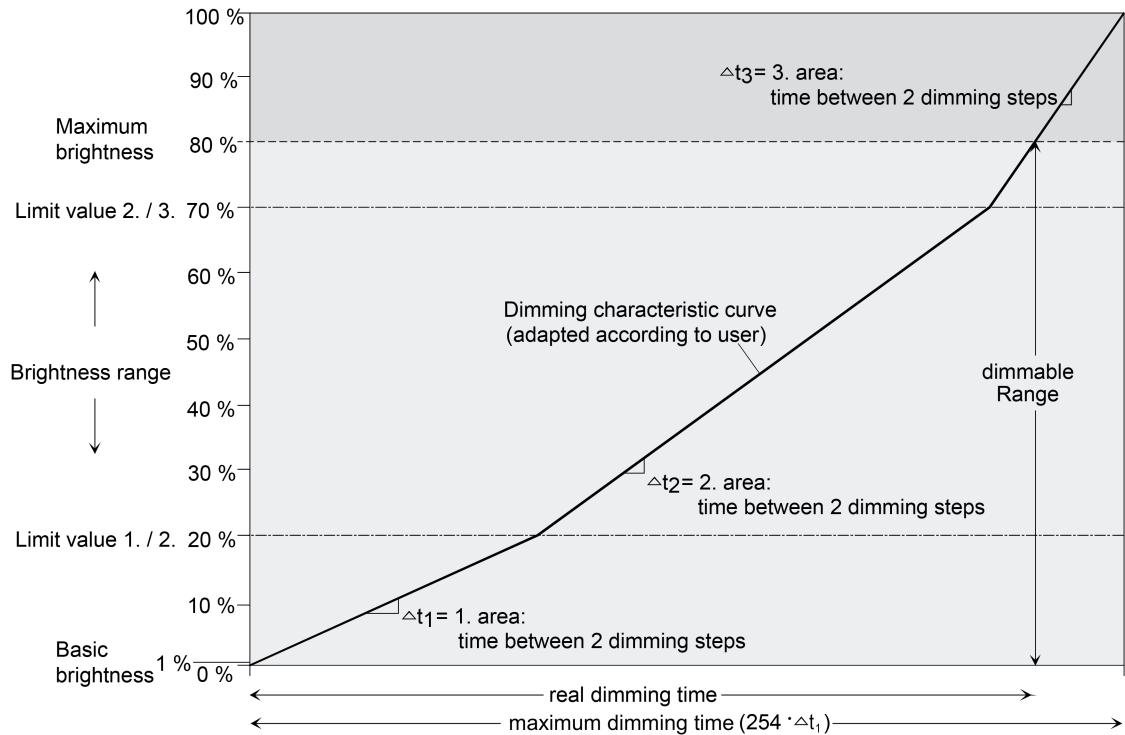

Figure 17: User-defined dimming characteristic as an example with basic brightness and maximum brightness (example with 3 areas)

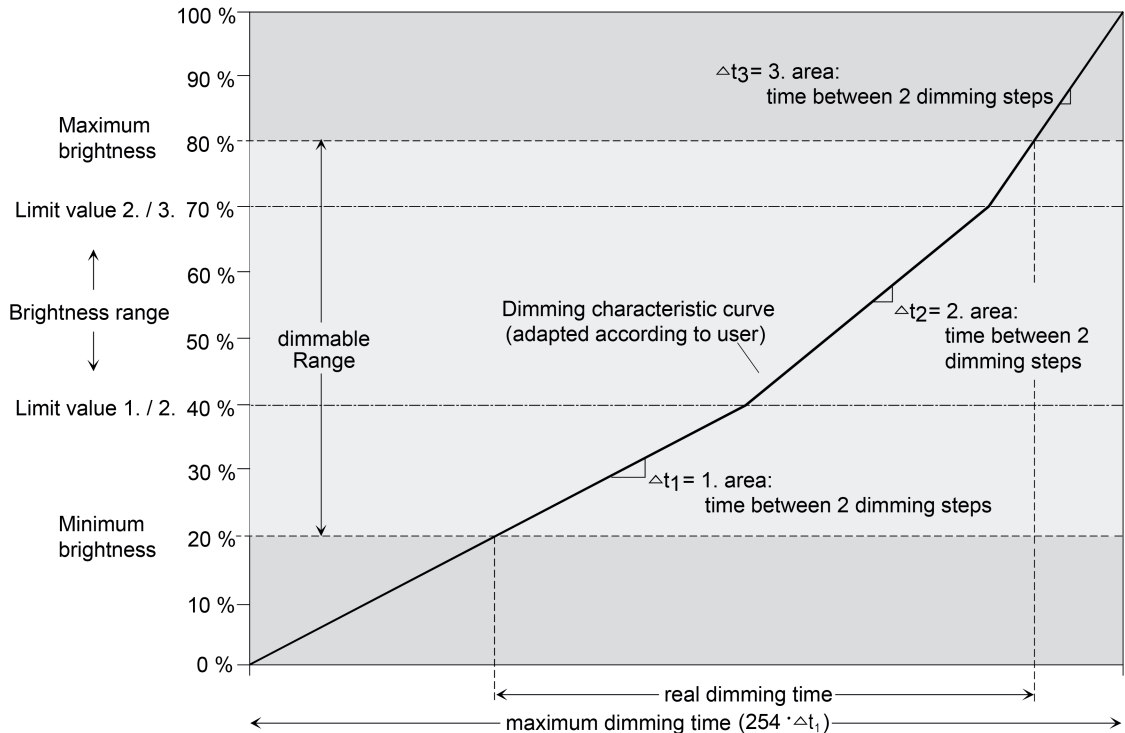

Figure 18: User-defined dimming characteristic as an example with minimum brightness and maximum brightness (example with 3 areas)

### Setting dimming behaviour for absolute dimming

The dimming behaviour for the absolute dimming can be set separately in the ETS for each dimming channel via the "Brightness value" object.

- Set the parameter "Dimming behaviour after receipt of a brightness value" on parameter page "Ex - General" to "Dim".  
Once a new brightness value is received, it is set by means of the configured dimming increment time and on the predefined dimming characteristic.
- Set the parameter "dimming behaviour after receipt of a brightness value" to "jump to".  
As soon as a new brightness value is received it will be instantly jumped to. A dimming operation does not take place.
- Set the parameter "dimming behaviour after receipt of a brightness value" to "fading". In addition, on the parameter "Time for brightness value via fading", define the necessary fading time for dimming the scene brightness value.

Newly received brightness values will be dimmed. The dim fading is activated. The fading time defines the duration of the dimming procedure required to reach the new brightness value. The brightness value of a dimming channel on which the dimming starts and the configured dimming characteristic have no significance. The dimming procedure thus always requires the exact predefined time when specifying a new brightness value.

- i** Brightness values can also be set by a disabling or forced position function. Absolute dimming can also be activated, even in case of bus voltage failure, after bus voltage return or after programming with the ETS, by specifying brightness values. In the case of these absolute dimming functions, the brightness values are always instantly jumped to. During a scene recall, the dimming behaviour can be configured separately.

- i** If the burn-in function is active, 100 % is always jumped to on switching on a dimming channel via any brightness value.

### Setting dimming behaviour in OFF state for relative dimming

A relative dimming process can be triggered by the 4-bit "Dimming" communication object available separately in each dimming channel. The data format of the "dimming" object complies with the KNX standard DPT "3.007", which means that the dimming direction and relative dimming increments can be predefined in the dimming telegram or dimming procedures can also be stopped. A relative dimming process is executed via the object until the configured basic minimum or maximum brightness of the dimming channel is set, the dimming value reaches the dimming increment predefined in the telegram or a stop telegram is received. A relative dimming process allows a brightness value to be changed constantly and always starts from the brightness that is set stationary or dynamically at the time of the incoming dimming telegram. A relative dimming telegram can also switch on a dimming channel if this is in the "OFF" state. In some applications, it may be necessary, however, for a switched off dimming channel to remain off until a relative dimming telegram is received. This is interesting when using light scenes, for instance:

Several dimming channels are set to a defined brightness value via a light scene. Other channels are switched off by the scene. Only the brightness of channels not switched off by the scene recall should be changed by dimming up afterwards. Here, it is necessary for dimming channels not to react to a relative dimming operation and thus not to switch on.

The parameter "Behaviour when OFF by relative dimming" defines whether or not a dimming channel in the "OFF" state reacts to a relative dimming telegram.

- Set the parameter to "Dimming up switches channel ON (Standard)".  
The dimming channel always reacts to a relative dimming telegram and executes a dimming process. In the "OFF" state, the channel switches on with a "dim up" telegram.
- Set the parameter to "Dimming up is ignored (channel remains OFF)".  
The dimming channel only reacts to a relative dimming telegram when it is switched on. In the "OFF" state, the channel ignores a "dim up" telegram.

#### 4.2.4.2.4 Response after a device reset

The switching states or brightness values of the dimming channels after a bus voltage failure, bus voltage return or after an ETS programming operation, can be preset separately.

##### Presetting the behaviour after ETS programming

The parameter "Behaviour after ETS programming" is available separately for each dimming channel on the parameter page "Ex - General". This parameter can be used to configure the brightness behaviour of a channel, irrespective of the behaviour after bus voltage return.

- Set the parameter to "no reaction".

After an ETS programming operation, the control voltage remains the same and the relay is switched to the most recent switching state defined by bus operation. This ensures that relays altered by a manual operation are in the right switching state. If the relays are already in the correct position, then the actuator does not react.

- Set the parameter to "Switch off".

The dimming channel is switched off after a programming in the ETS. The assigned relay switches off if the switching status of another assigned dimming channel switches on the relay - depending on the configuration. The control voltage is set to approx. 0.8 V if the mains voltage support is still switched on connected consumers. Otherwise, the control value is undefined.

- Set the parameter to "Brightness value". In the parameter "Brightness value after ETS programming operation", configure the required brightness value. It is important that the configured brightness value does not undershoot the set minimum brightness (if present) or exceed the maximum brightness.

After an ETS programming operation, the dimming channel is set to the predefined brightness value. The assigned relay switches on.

- Set the parameter to "Behaviour as on bus voltage return".

After an ETS programming operation, the dimming channel will behave in the manner defined in the parameter "Behaviour after bus voltage return". If the behaviour there is configured to "Brightness as before bus voltage failure", then that brightness value is also set after an ETS programming operation which was active at the time of the last bus voltage failure. An ETS programming operation does not overwrite the saved brightness value.

- i The configured behaviour will be executed after every application or parameter download by the ETS. A simple download of the physical address alone or partial programming of only the group addresses has the effect that this parameter is disregarded and that the configured "Behaviour after bus voltage return" will be executed instead.
- i A switching state and brightness value set after an ETS programming cycle is added to the feedback objects. Actively transmitting feedback objects also only first transmit after an ETS programming cycle when the initialisation has finished and, if necessary, the "delay time after bus voltage return" has elapsed.
- i After an ETS programming operation, the disabling functions and the forced-positions are always deactivated. The brightness values and states of the forced position objects saved in case of the bus voltage failure are deleted.

##### Setting the behaviour in case of bus voltage failure

The parameter "Behaviour in case of bus voltage failure" is available separately for each dimming channel on the parameter page "Ex - General".

- Set the parameter to "no reaction".



If there is a bus voltage failure, the relay is switched to the switching state most recently defined by bus operation. This ensures that relays altered by a manual operation are in the right switching state. If the relays are already in the correct position, then the actuator does not react.

- Set the parameter to "Switch off".

The dimming channel is switched off in the case of bus voltage failure. The assigned relay switches off if the switching status of another assigned dimming channel switches on the relay - depending on the configuration.

- Set the parameter to "Switch on".

The dimming channel is switched on in the case of bus voltage failure. The assigned relay switches on.

- i** If there is a bus voltage failure, the 1-10 V control voltage, and thus the brightness of connected consumers switched on with mains voltage, is always set to the maximum value (approx. 10 V), because the control unit can no longer limit the voltage (the device is solely supplied by the bus and the device electronics can thus no longer function if there is a bus voltage failure). If the mains voltage of the connected consumers is switched off, the control voltage is undefined.
- i** Active disabling functions or forced position functions are cancelled and remain inactive until they are reactivated after a bus voltage return.
- i** In case of a bus voltage failure, the current states of the forced-positions are also saved so that they can be tracked on return of bus voltage if necessary (depending on the parameterization of the forced positions).
- i** In case of a bus voltage failure, the current brightness values of all dimming channels are saved internally so that these brightness values can be reset after bus voltage return if this is configured in the ETS. The data is stored before the reaction configured for the case of bus voltage failure takes place and only if the power supply is still present, or if the supply fails completely after the bus voltage has been available before without interruption for at least 20 seconds after the last reset (storage capacitors sufficiently charged for storage purposes). In all other cases nothing is stored (Brightness value = "0")!

## Setting the behaviour after bus voltage return

The parameter "Behaviour in case of bus voltage return" is created separately for each dimming channel on the parameter page "Ex - General".

- Set the parameter to "no reaction".

After bus voltage return, the brightness value and relay are brought into the state set on bus voltage failure (in accordance with the parameter "Behaviour on bus voltage failure"). If, during the bus failure, the relay was not moved manually, the actuator will not show any switching reaction. Otherwise, the relay switches to the specified position.

- Set the parameter to "Switch off".

The dimming channel is switched off after bus voltage return. The assigned relay switches off if the switching status of another assigned dimming channel switches on the relay - depending on the configuration. The control voltage is set to approx. 0.8 V if the mains voltage support is still switched on connected consumers. Otherwise, the control value is undefined.

- Set the parameter to "Brightness value". In the parameter "Brightness value after bus voltage return", configure the required brightness value. It is important that the configured brightness value does not undershoot the set minimum brightness (if present) or exceed the maximum brightness.

After bus voltage return, the dimming channel is set to the predefined brightness value. The assigned relay switches on.

- Set parameter to "brightness before bus voltage failure".

After bus voltage return, the switching state and brightness value last set and internally stored before bus failure will be tracked.

- Preset parameter to "Activate staircase function". This setting is only available when the staircase function of the appropriate dimming channel is enabled.

The staircase function is – irrespective of the "Switching" object - activated after bus voltage return.

- ❗ Setting "Brightness before bus/mains voltage failure": An ETS programming operation of the application or the parameter resets the stored switching state to "OFF".
- ❗ A switching state and brightness value set after bus voltage return is tracked in the feedback objects. Actively transmitting feedback objects first transmit, however, after bus voltage return, when the initialisation of the actuator has finished, and if necessary the "Delay time after bus voltage return" has elapsed.
- ❗ In the case of forced position as supplementary function: The communication object of the forced position can be initialised separately after bus voltage return. This has an effect on the reaction of the dimming channel when the forced position is activated. The configured "Behaviour after bus voltage return" is only executed when no forced position after a bus voltage return is activated.
- ❗ In the case of enabling function as supplementary function: Active disabling functions are always inactive after bus voltage return.

## 4.2.4.2.5 Feedback for switching status and brightness value

### Functional description

The actuator can track the current switching state and brightness value of a dimming channel via separate feedback objects and can also transmit them to the bus, if the bus voltage is on. The actuator calculates the object value of the feedback objects during each switching or dimming procedure. The actuator tracks the switching state or brightness value and updates the feedback objects even if a dimming channel, for example, is activated by a supplementary function or scene function.

The following feedback objects can be enabled independently of each other for each channel...

- Switching feedback (1 bit)
- Switching feedback of shared relay status (1-bit)
- Feedback brightness value (1 byte)

**i** The 1-bit feedback "Shared relay status" is only available for dimming channels, if - depending on the configuration - multiple channels affect the same relay. This feedback object then displays the internally combined switching status of the relay (OR logic operation of the individual switching status of the dimming channels). If a dimming channel independently affects a relay, then the "Feedback of shared relay status" is not available. The "Switching feedback" is always available for dimming channels and signals the individual switching state of each channel.

The switching status feedback objects are updated after the following events...

- Immediately after switching on a dimming channel (if necessary, first after a switch-on delay has elapsed and at the beginning of a soft ON dimming procedure / also after a staircase function).
- After switching off a dimming channel (if necessary, first after a run-on-time has elapsed and at the end of a soft OFF dimming procedure / also after a staircase function).
- Immediately after switching off by means of the automatic switch-off function.
- At the beginning of a dimming procedure when dimming on (relatively high dimming or brightness value = 1...100 %) a dimming channel.
- At the end of a dimming procedure when dimming off (brightness value = 0 %) a dimming channel.
- During updating of the switching state from "ON" to "ON" or "OFF" to "OFF" when the dimming channel is already switched on or off. However, only if the parameter "Update of the object value for switching status feedback" is configured to "On each update of obj. 'Switching'/'Central'".
- At the beginning or end of a disabling or forced position function, if a state changes or the parameter "Update of the object value for switching status feedback" is configured to "On each update of obj. 'Switching'/'Central'".
- Always on bus voltage return or at the end of any ETS programming process (if necessary, also delayed).

The relay status feedback objects are updated after the following events...

- Immediately after closing or opening of a relay contact ("1" = Relay closed, "0" = Relay opened)
- Always on bus voltage return or at the end of any ETS programming process (if necessary, also delayed).

The brightness value feedback object is updated after the following events...

- At the end of a relative (4-bit) or absolute (1-byte) dimming procedure.
- After switching on a dimming channel, if the switch-on brightness is set (if necessary, first after a switch-on delay has elapsed and at the end of a soft ON dimming procedure / also after a staircase function).
- After switching off a dimming channel (if necessary, first after a run-on-time has elapsed and at the end of a soft OFF dimming procedure / also after a staircase function).
- Immediately after switching off by means of the automatic switch-off function.

- At the end of a dimming operation, if the brightness value changes (if a brightness value specification undershoots the previously set and fed back minimum brightness as a result of relative or absolute dimming from outside or exceeds the previously set and fed back maximum brightness, the actuator does not update a brightness value feedback according to the minimum brightness or maximum brightness).
  - At the beginning or end of a disabling or forced position function, if a brightness value changes or the parameter "Update of the object value for brightness value feedback" is configured to "On each update of obj. 'Brightness value'".
  - Always on bus voltage return or at the end of any ETS programming process (if necessary, also delayed).
- i** An adjustment of the sliding switches of the relays is not detected by the application controller of the device. In consequence, even if the bus voltage is switched on, no feedback is transmitted on a manual actuation.
- i** In the case of enabling function as supplementary function: A "flashing" dimming channel is always fed back as "switched on" and with switch-on brightness.

### Activate switching status feedback

The switching status feedback can be used as an active message object or as a passive status object. As an active message object, the switching status feedback information is also directly transmitted to the bus whenever the feedback value is updated. As a passive status object, there is no telegram transmission after an update. In this case, the object value must be read out. The ETS automatically sets the object communication flags required for proper functioning. The parameter "Feedback switching status?" is available separately for each dimming channel on the parameter page "Ex - Feedback".

Precondition:

The feedbacks must be enabled on parameter page "Ex - Enabled functions".

- Set the parameter to "feedback object is active signalling object".  
The objects "Switching feedback" and "Switching feedback, shared relay status" are enabled. A switching status is transmitted as soon as it is updated. An automatic telegram transmission of the feedback takes place after bus voltage return or after programming with the ETS.
  - Set the parameter to "feedback object is passive status object".  
The objects "Switching feedback" and "Switching feedback, shared relay status" are enabled. A switching status will be transmitted in response only if the feedback object is read out from by the bus. No automatic telegram transmission of the feedback takes place after bus voltage return or after programming with the ETS.
  - Set the parameter to "no reaction".  
All the switching status feedback of the affected dimming channel is deactivated.
- i** Feedback of the current switching status via the "switching" object is not possible.

### Set update of "Switching feedback"

In the ETS, you can specify when the actuator should update the feedback value for the switching status (object "Switching feedback") in case of an actively transmitting communication object. The object value updated by the actuator is then signalled actively to the bus. The parameter "Upgrade of the object value for feedback of switching status" can be preset separately for each dimming channel on the parameter page "Ex - Feedback".

Precondition:

The feedbacks must be enabled on parameter page "Ex - Enabled functions". In addition, the switching status feedback must be configured to actively transmitting.

- Set the parameter to "after each update obj. 'Switching'/'Central'".

The actuator updates the feedback value in the object once a new telegram is received on the input objects "Switching" or "Central switching" or the switching state changes internally (e.g. through a time function). With an actively transmitting feedback object, a new telegram is also then actively transmitted to the bus each time. The telegram value of the feedback does not necessarily have to change in the process. Hence, a corresponding switching status feedback is also generated on the "Switching" object such as in the case of cyclical telegrams for example.
- Set the parameter to "Only if the feedback value changes".

The actuator only updates the feedback value in the object if the telegram value (e.g. "OFF" to "ON") also changes or the switching state changes internally (e.g. through a time function). If the telegram value of the feedback does not change (e.g. in the case of cyclical telegrams to the "Switching" object with the same telegram value), the actuator does not transmit any feedback. Consequently, with an actively transmitting feedback object, no telegram with the same content will be transmitted repeatedly either. This setting is recommendable, for instance, if the "Switching" and "Switching feedback" objects are linked to an identical group address. This is often the case when activating by means of light scene push-button sensors (recall and storage function).
- ❏ The parameter "Update of the object value for switching status feedback" has no effect on the "Switching feedback, shared relay status". This feedback only updates itself when there is a change to the relay switching state, after a bus voltage return or an ETS programming operation.

## Setting switching status feedback on bus voltage return or after programming with the ETS

If used as active message object, the switching status feedback states are transmitted to the bus after bus voltage return or after programming with the ETS. In these cases, the feedback telegram can be time-delayed with the delay being preset globally for all dimming channels together.

- Set the parameter "Time delay for feedback after bus voltage return?" on parameter page "Ex - Feedback" to "Yes".

The switching status telegram is transmitted with a delay after bus voltage return or after an ETS programming operation. No feedback telegram is transmitted during a running delay, even if the switching state changes during this delay.
- Set the parameter "Time delay for feedback after bus voltage return?" to "no".

The switching status telegram is transmitted immediately after bus voltage return or after an ETS programming operation.

## Setting cyclical transmission of the switching status feedback telegram

The switching status feedback telegrams can, if active, also be transmitted cyclically, in addition to the transmission after updating.

- Set the parameter "Cyclical transmission of feedback telegram?" on parameter page "Ex - Feedback" to "Yes".

Cyclical transmission is activated.
- Set the parameter "Cyclical transmission of feedback telegram?" to "no".

Cyclical transmission is deactivated so that the feedback is transmitted to the bus only when updated by the actuator.
- ❏ The cycle time is defined centrally for all dimming channels on the parameter page "Times".

- i** During an active delay after bus voltage return no feedback telegram will be transmitted even if a switching state changes.

## Activate brightness value feedback

The brightness value feedback can be used as an active message object or as a passive status object. As an active message object, the brightness value feedback information is also directly transmitted to the bus for each update of the feedback value. As a passive status object, there is no telegram transmission after an update. In this case, the object value must be read out. The ETS automatically sets the object communication flags required for proper functioning. The parameter "Feedback brightness value?" is available separately for each dimming channel on the parameter page "Ex - Feedback".

Precondition:

The feedbacks must be enabled on parameter page "Ex - Enabled functions".

- Set the parameter to "feedback object is active signalling object".  
The "brightness value feedback" object is enabled. The brightness value is transmitted once this is updated. An automatic telegram transmission of the feedback takes place after bus voltage return or after programming with the ETS.
  - Set the parameter "Feedback object is passive status object".  
The "brightness value feedback" object is enabled. The brightness value will be transmitted in response only if the feedback object is read out from by the bus. No automatic telegram transmission of the feedback takes place after bus voltage return or after programming with the ETS.
  - Set the parameter to "no reaction".  
The brightness value feedback is deactivated.
- i** A feedback of the current brightness value via the "brightness value" object – even if a T-Flag is set – is not possible.

## Presetting update of the brightness value feedback

In the ETS you can specify when the actuator should update the feedback value for the brightness value in case of an actively transmitting communication object. The object value updated by the actuator is then signalled actively to the bus.

The parameter "Upgrade of the object value for feedback of brightness value" is available separately for each dimming channel on the parameter page "Ex - Feedback".

Precondition:

The feedbacks must be enabled on parameter page "Ex - Enabled functions". In addition, the brightness value feedback must be configured to actively transmitting.

- Set the parameter to "after each update obj. brightness value feedback".  
The actuator updates the feedback value in the object once a new telegram is received on the input objects "Switching", "Central switching" or "Brightness value" or the brightness value changes internally (e.g. through a time function). With an actively transmitting feedback object, a new telegram is also then actively transmitted to the bus each time. The telegram value of the feedback does not necessarily have to change in the process. Hence, a corresponding brightness value feedback is also generated on the "brightness value feedback" object such as in the case of cyclical telegrams for example.
- Set the parameter to "Only if the feedback value changes".

The actuator only updates the feedback value in the object if the telegram value (e.g. "0 %" to "100 %") also changes or the brightness value changes internally (e.g. through a time function). If the telegram value of the feedback does not change (e.g. in the case of cyclical telegrams to the "Brightness value" object with the same telegram value), the actuator does not transmit any feedback. Consequently, with an actively transmitting feedback object, no telegram with the same content will be transmitted repeatedly either. This setting is recommendable, for instance, if the "brightness value" and "brightness value feedback" objects are linked to an identical group address. This is often the case when activating by means of light scene push-button sensors (recall and storage function).

## **Activating brightness value feedback on return of bus voltage or after programming with the ETS**

If used as active message object, the brightness value feedback information is transmitted to the bus after bus voltage return or after programming with the ETS. In these cases, the feedback telegram can be time-delayed with the delay being preset globally for all dimming channels together.

- Set the parameter "Time delay for feedback after bus voltage return?" on parameter page "Ex - Feedback" to "Yes".  
The brightness value feedback will be transmitted with a delay after bus voltage return or after programming with the ETS. No feedback telegram is transmitted during a running delay, even if the brightness value changes during this delay.
- Set the parameter "Time delay for feedback after bus voltage return?" to "no".  
The brightness value feedback will be transmitted immediately after bus voltage return or after programming with the ETS.

## **Presetting the cyclical transmission function for the brightness value feedback telegram**

The brightness value feedback telegram can also be transmitted cyclically via the active message object in addition to the transmission after updating.

- Set the parameter "Cyclical transmission of feedback telegram?" on parameter page "Ex - Feedback" to "Yes".  
Cyclical transmission is activated.
  - Set the parameter "Cyclical transmission of feedback telegram?" to "no".  
Cyclical transmission is deactivated so that the feedback telegram is transmitted to the bus only when updated by the actuator.
- i** The cycle time is defined centrally for all dimming channels on the parameter page "Times".
- i** During an active delay after bus voltage return no feedback telegram will be transmitted even if a brightness value changes.

## 4.2.4.2.6 Timing functions

### Functional description

Up to two time functions can be preset for each dimming channel independent of each other. The time functions affect the communication objects "Switching" or "Central switching" only (if at least one of the central functions is activated for the channel concerned) and delay the object value received depending on the telegram polarity.

### Activating switch-on delay

The switch-on delay can be activated separately in the ETS for each dimming channel.

Precondition:

The timing functions must be enabled on parameter page "Ex - Enabled functions".

- Set the parameter "Selection of time delay" to "Switch-on delay" or to "Switch-on delay and switch-off delay". Configure the desired switch-on delay.

The switch-on delay is enabled. After reception of an ON telegram via the "switching" object, the configurable time is started. Another ON-telegram triggers the time only when the parameter "Switch-on delay retriggerable" is set to "yes". An OFF-telegram received during the ON-delay will end the delay and sets the switching status to "OFF".

### Activating switch-off delay

The switch-off delay can be activated separately in the ETS for each dimming channel.

Precondition:

The timing functions must be enabled on parameter page "Ex - Enabled functions".

- Set the parameter "Selection of time delay" to "Switch-off delay" or to "Switch-on delay and switch-off delay". Configure the desired switch-off delay.

The switch-off delay is enabled. After reception of an OFF-telegram via the "switching" object, the configurable time is started. Another OFF-telegram triggers the time only when the parameter "switch-off delay retriggerable?" is set to "yes". An ON-telegram received during the OFF-delay will end the delay and sets the switching status to "ON".

- i** At the end of a disabling function or forced position function, the brightness state received during the function or adjusted before the function can be tracked. Residual times of time functions are also tracked if these had not yet fully elapsed at the time of the reactivation or forced control.
- i** The time delays do not influence the staircase function if this is enabled.
- i** A time delay still in progress will be fully aborted by a reset of the actuator (bus voltage failure or ETS programming).



## 4.2.4.2.7 Soft ON/OFF function

### Functional description

The soft-functions permit a dimming channel to be switched on or off at reduced speed when a switching command is received via the "Switching" or "Central switching" communication objects.

If the soft ON function is activated, a dimming procedure is executed until the switch-on brightness when switching on. This also occurs if the dimming channel is already switched on to a brightness value smaller than switch-on brightness. Likewise, with the soft OFF function, a dimming procedure is executed to 0 % brightness after receipt of an OFF telegram (Figure 19).

The dimming speeds can be configured separately in the ETS for the soft ON and soft OFF function. The relative dimming increment time between 2 of 255 dimming increments is configured directly.

The soft ON or soft OFF functions are not retriggerable by the receipt of further switching telegrams while maintaining the switching status. The soft functions can be activated and configured separately in the ETS.

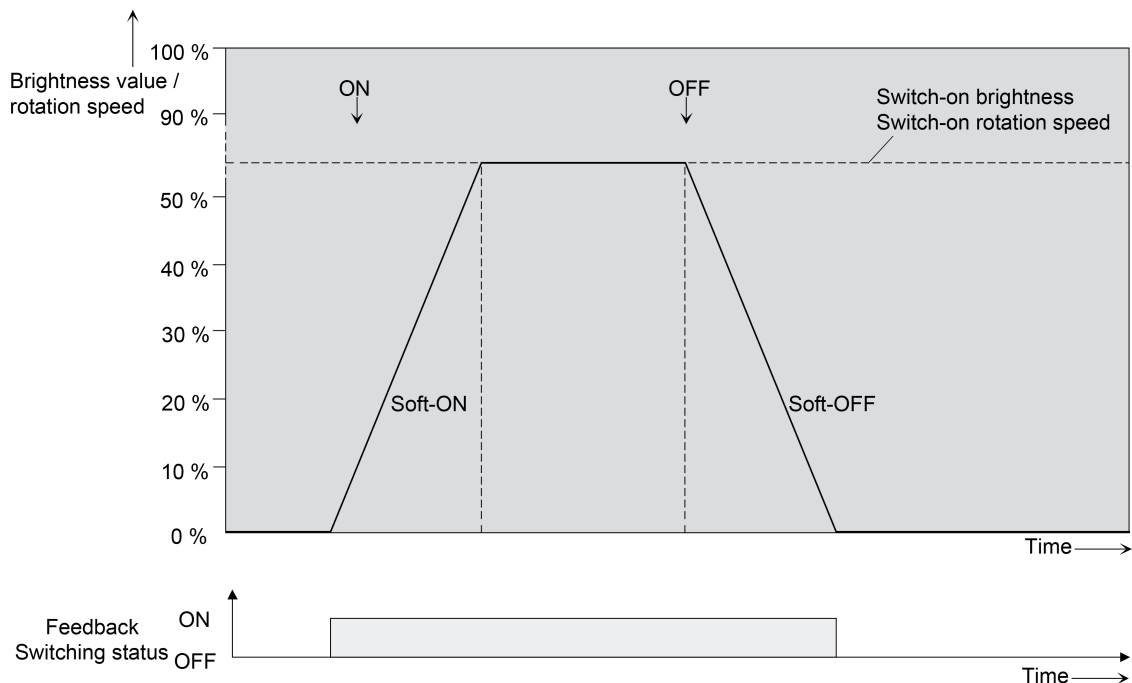

Figure 19: Dimming behaviour of the soft ON/OFF functions (as an example)

- i The soft functions also have effects on the switching edges of the staircase function.
- i A dimming channel disabled via the bus can also flash for the disabling function depending on the ETS configuration. Dimming is not executed with the soft functions during ON and OFF flashing.

### Enabling and setting soft ON function

The soft ON function can be set separately for each dimming channel in the ETS.

#### Precondition

The switch-on/switch-off behaviour on the parameter page "Ex - Enabled functions" must be enabled.

- Set the parameter "Soft ON function ?" on the parameter page "Ex – Switch-on/switch-off behaviour" to "yes".  
The soft ON function is enabled. The parameter for the dimming increment time (time between 2 of 255 dimming increments) of the soft ON function becomes visible.
- Configure the parameter "Time for dimming increment soft ON" to the required dimming increment time.

### **Enabling and setting soft OFF function**

The soft OFF function can be set separately for each dimming channel in the ETS.

#### **Precondition**

The switch-on/switch-off behaviour on the parameter page "Ex - Enabled functions" must be enabled.

- Set the parameter "Soft OFF function ?" on the parameter page "Ex – Switch-on/switch-off behaviour" to "yes".  
The soft OFF function is enabled. The parameter for the dimming increment time (time between 2 of 255 dimming increments) of the soft OFF function becomes visible.
- Configure the parameter "Time for dimming increment soft OFF" to the required dimming increment time.

## 4.2.4.2.8 Automatic switch-off

### Functional description

The switch-off function permits automatic switching of a dimming channel after a brightness value was dimmed or jumped to and this new brightness value is below a switch-off brightness set in the ETS. A time delay can be configured optionally up to switching off.

The switch-off function is activated after reaching a constant brightness value, i.e. after a completed dimming procedure.

The automatic switch-off function, for example, not only makes it possible to set the lighting to basic brightness but to switch off as well by means of relative dimming. A further application is time-controlled 'Good night switch-off' of a dimmed children's room lighting or the automatic switching off of a fan at very low speed (in the "speed controller" operating mode).

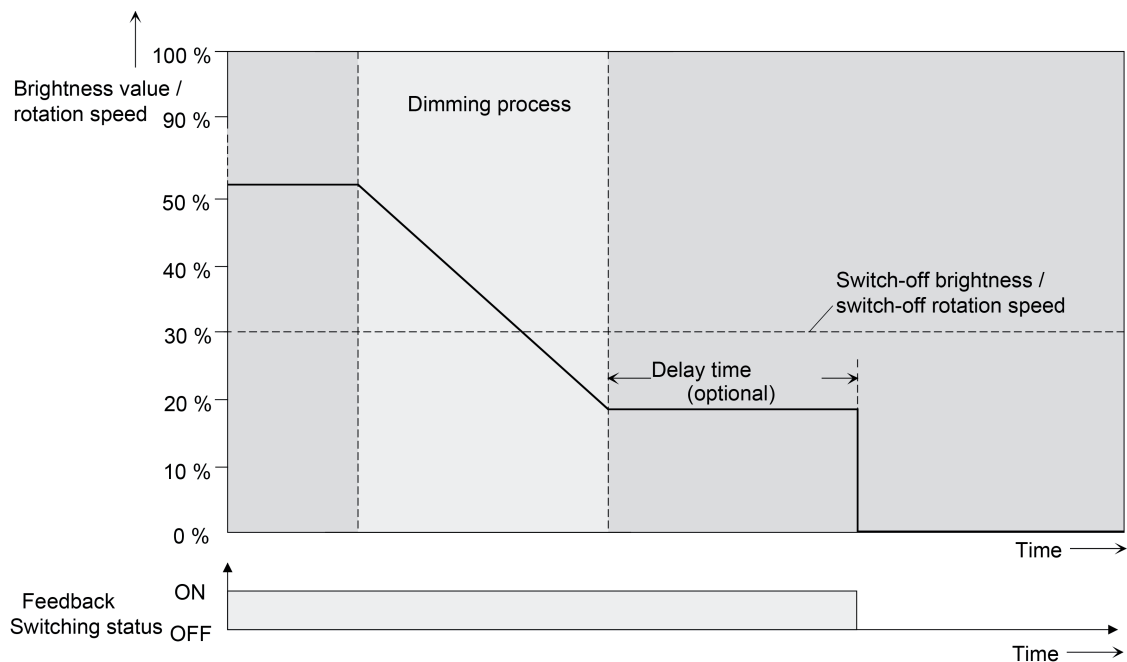

Figure 20: Dimming and switching behaviour of the automatic switch-off function

- i** Switching off always takes place without soft OFF function, i.e. jumping.
- i** The switch-off brightness in the dimmable brightness range can be set between basic and maximum brightness or minimum and maximum brightness. The switch-off function is always active if the switch-off brightness is configured to maximum brightness and the maximum brightness is randomly undershot.
- i** The feedback objects for switching state and brightness value are updated by the automatic switch-off function after switching off.

The automatic switch-off can firstly be activated by a dimming procedure initiated via the 4-bit ("dimming") or 1-byte ("brightness value") communication object. Secondly, the automatic switch-off can also be activated if a dimming channel is switched on (switch-on brightness < switch-off brightness) or a brightness is set by programming with the ETS or by a bus voltage return. The automatic switch-on can also be activated during a scene recall.

- i** It should be noted that the disabling function or forced position function overrides the switch-off function. If the switch-off function is overridden, the actuator terminates the evaluation of the switch-off brightness.

## Enabling automatic switch-off function

The automatic switch-off function can be set separately for each dimming channel in the ETS.

Precondition

The switch-on/switch-off behaviour on the parameter page "Ex - Enabled functions" must be enabled.

- Set the parameter "Automatic switch-off when undershooting a brightness ?" on the parameter page "Ex – Switch-on/switch-off behaviour" to "yes".  
The automatic switch-off function is enabled and activated. Additional parameters become visible.

## Setting the switch-off brightness

The switch-off brightness must be defined for the switch-off function. The switch-off brightness is set separately for each dimming channel in the ETS.

Precondition

The switch-off function must be enabled in the ETS.

- Set the parameter "Switch off if brightness value is smaller" on parameter page "Ex – Switch-on/switch-off behaviour" to the required brightness value.

Once a dimming procedure causes a value to fall below the parameterized switch-off brightness and once the brightness has been set to constant, the dimming channel concerned switches off or alternatively starts the delay until switching off.

- i** It should be noted that the configured value for the switch-off brightness is greater than any configured minimum brightness and less than the set maximum brightness (minimum brightness < switch-off brightness < maximum brightness)!
- i** Using the staircase function with pre-warning/continuous lighting: The reduced brightness of the pre-warning or continuous lighting does not start the switch-off function after reaching or undershooting the switch-off brightness.

## Setting the delay of the switch-off function

A delay can be activated before the switch-off function switches-off automatically after undershooting the switch-off brightness at the end of a dimming procedure. The time for the delay can optionally be enabled separately for each dimming channel.

Precondition

The switch-off function must be enabled in the ETS.

- Configure the parameter "Delay until switching off" on the parameter page "Ex – Switch-on-/Switch-off behaviour" to the required delay time.

Once a dimming procedure causes a value to fall below the parameterized switch-off brightness and once the brightness has been set to constant, the actuator triggers the delay time. The dimming channel concerned switches off for good once the delay time has elapsed. The delay time can be re-triggered by further dimming procedures.

## 4.2.4.2.9 Staircase function

### Functional description

The staircase function can be used for implementing time-controlled lighting of a staircase or for function-related applications. The staircase function must be enabled in the ETS on parameter page "Ex - Enabling functions" in order for the required communication objects and parameters to be visible.

The staircase function is activated via the communication object "staircase function start / stop" and is independent of the "switching" object of a dimming channel. In this way, parallel operation of time and normal control is possible, whereby the command last received is always executed: A telegram to the "switching" object or a scene recall at the time of an active staircase function aborts the staircase time prematurely and presets the switching state according to the received object value (the time delays are also taken into account) or scene value. Likewise, the switching state of the "switching" object can be overridden by a staircase function.

Time-independent continuous light switching can also be implemented in combination with a disabling function because the disabling function has a higher priority and overrides the switching state of the staircase function.

The staircase function can also be extended by means of a supplementary function. At the same time, it is possible to activate a time extension. The "time extension" permits retriggering of an activated staircase via the object "Staircase function Start / Stop" n times. Alternatively, the "Time preset via the bus" can be set. With this supplementary function, the configured staircase time can be multiplied by a factor received via the bus, thus it can be adapted dynamically. Furthermore, an extension of the staircase function can be implemented by means of a separate switch-on delay and pre-warning function. During the pre-warning, the brightness of a dimming channel can be reduced. According to DIN 18015-2, the pre-warning should warn persons on the staircase that the light will soon be switched off. As an alternative to the pre-warning at the end of the staircase time, the actuator can activate reduced continuous lighting. In this way, for example, long, dark hallways can have permanent basic lighting.

### Specifying switch-on behaviour of the staircase function

An ON telegram to the "Staircase function start/stop" object activates the staircase time ( $T_{ON}$ ), the duration of which is defined by the "Staircase time" parameters. The output switches to switch-on brightness.

At the end of the staircase time, the dimming channel shows the "reaction at the end of the staircase time" configured in the ETS. At the same time, the channel can switch off, optionally activate the pre-warning time ( $T_{Vorwarn}$ ) of the pre-warning function (see page 64-65) or dim to the reduced continuous lighting (application: e.g. long, dark hallways). Taking into account any possible pre-warning function, this gives rise to the example switch-on behaviour of the staircase function (Figure 21).

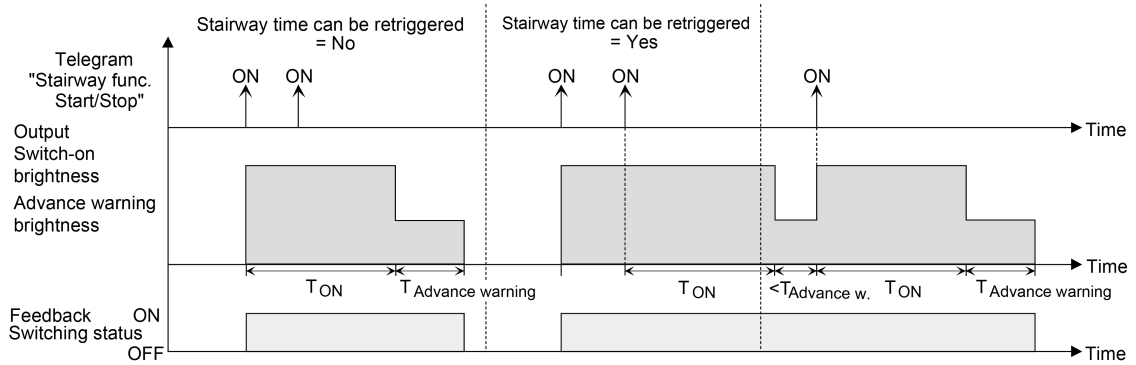

Figure 21: Switch-on behaviour of the staircase function without soft functions

In addition, switching on can be influenced by the soft functions of the actuator. Taking into account any soft ON and soft OFF function, this gives rise to a modified switch-on behaviour of the staircase function (Figure 22).

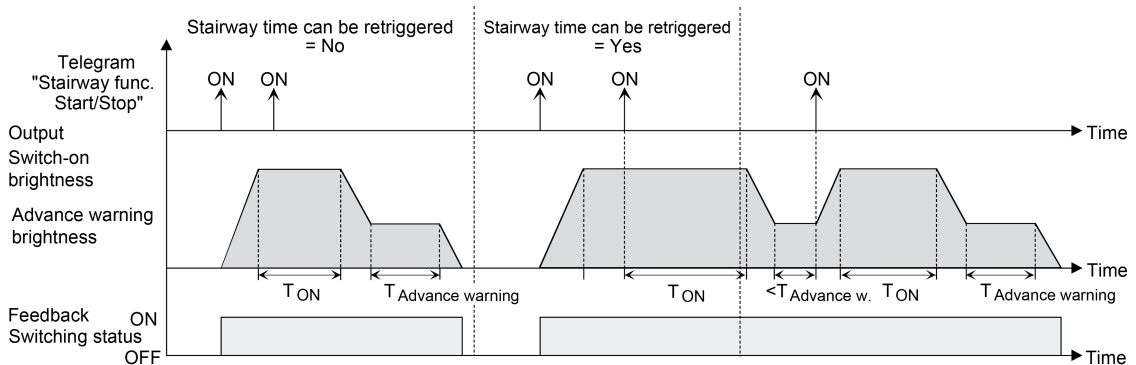

Figure 22: Switch-on behaviour of the staircase function with soft functions (for example with minimum brightness = 0 %)

- Set the parameter "Staircase function ?" on parameter page "Ex - Enabled functions" to "Enabled".

The staircase function is enabled. Additional parameters become visible on the parameter page "Ex – Staircase function".
  - In the "Staircase time" parameter, configure the necessary switch-on time of the staircase function.
  - Set the parameter "Staircase time retrIGGERED" to "Yes".

Every ON telegram received during the ON phase of the staircase time retriggers the staircase time completely.
  - Alternatively, set the parameter "Staircase time retrIGGERED" to "No".

ON telegrams received during the ON phase of the staircase time are rejected. The staircase time is not retrIGGERED.
- i** An ON telegram received during the pre-warning time or during the reduced continuous lighting triggers the staircase time independently of the parameter "Staircase time retrIGGERED ?" always afterwards.

## Specifying switch-off behaviour of the staircase function

In the case of a staircase function, the reaction to an OFF telegram can also be configured on the object "Staircase function start/stop". At the end of the staircase time, a dimming channel always shows the "reaction at the end of the staircase time" configured in the ETS, without the receipt of an OFF telegram. At the same time, the channel can switch off, optionally activate the pre-warning time ( $T_{\text{Vorwarn}}$ ) of the pre-warning function (see page 64-65) or dim to the reduced continuous lighting (application: e.g. long, dark hallways).

If, on the other hand, the dimming channel receives an OFF telegram via the object "Staircase function start/stop", the actuator evaluates the parameter "Reaction to an OFF-telegram". In this case, the channel can react immediately to the OFF telegram and end the staircase time prematurely. Alternatively, the OFF telegram can be ignored.

Taking into account any possible pre-warning function, this gives rise to the example switch-off behaviour of the staircase function (Figure 23).

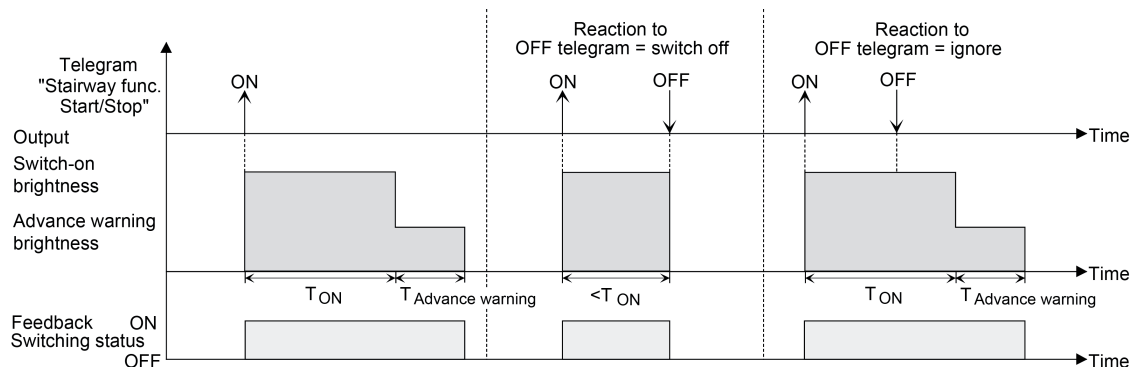

Figure 23: Switch-off behaviour of the staircase function without soft functions

In addition, the switch-off can be influenced by the soft functions of the actuator. Taking into account any soft ON and soft OFF function, this gives rise to a modified switch-off behaviour of the staircase function (Figure 24).

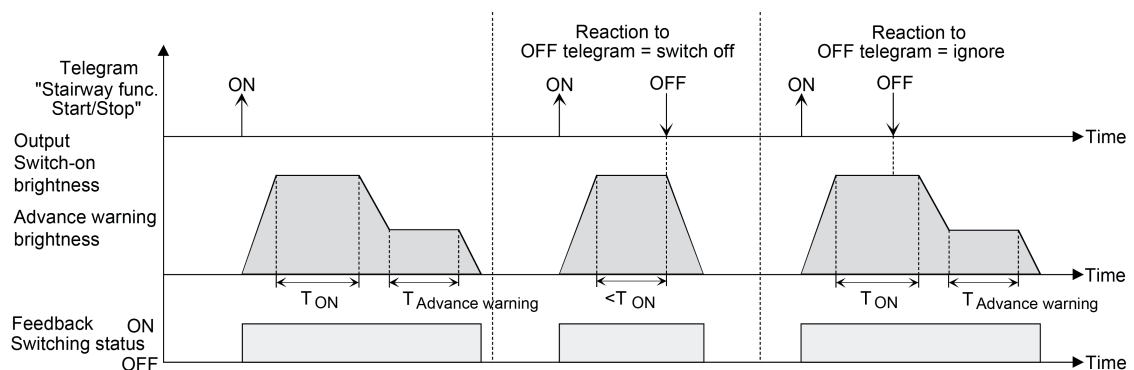

Figure 24: Switch-off behaviour of the staircase function with soft functions (for example with minimum brightness = 0 %)

The parameter "Reaction to OFF telegram" on the parameter page "Ex – Staircase function" defines whether the staircase time ( $T_{\text{EIN}}$ ) of the staircase function can be aborted prematurely.

### Precondition

The staircase function must be enabled in the ETS.

- Set the parameter "Reaction to OFF-telegram" to "switch off".

Once an OFF telegram is received via the object "Staircase function start/stop" during the ON phase of the staircase time, the dimming channel concerned switches off immediately. If the staircase time is stopped prematurely by such a telegram, there is no pre-warning, i.e. the pre-warning time is not started. It is also not dimmed to a reduced continuous lighting. It is also possible to switch off prematurely during a dimming procedure of a soft function or during a pre-warning or reduced continuous lighting.

- Set the parameter "Reaction to OFF-telegram" to ignore".

OFF telegrams received via the object "Staircase function start / stop" during the ON phase of the staircase function are rejected. The staircase time will be executed completely to the end with the configured "behaviour at the end of the staircase time".

- i** The parameter "Reaction to OFF telegram" does not influence the reception and the evaluation of OFF telegrams via the "Switching" object.

### Setting the pre-warning function of the staircase function

At the end of the switch-on time of the staircase function, the actuator for the dimming channel concerned shows the "reaction at the end of the staircase time" configured in the ETS. The channel can be set to switch off immediately, alternatively to dim to the reduced continuous lighting (application: e.g. long, dark hallways) or to execute the pre-warning function. If the parameter is configured to "activate pre-warning time", the pre-warning time ( $T_{Vorwarn}$ ) and pre-warning brightness can be configured in the ETS.

The pre-warning should, according to DIN 18015-2, warn persons still on the staircase that the light will soon be switched off. As a pre-warning, a dimming channel can be set to a pre-warning brightness before the channel switches off permanently. The pre-warning brightness is normally reduced in the brightness value compared to the switch-on brightness.

The pre-warning time is added to the staircase time ( $T_{EIN}$ ) (Figure 25). The pre-warning time influences the values of the feedback objects so that the switching state "OFF" and the value "0" is first tracked after the pre-warning time in the feedback objects has elapsed.

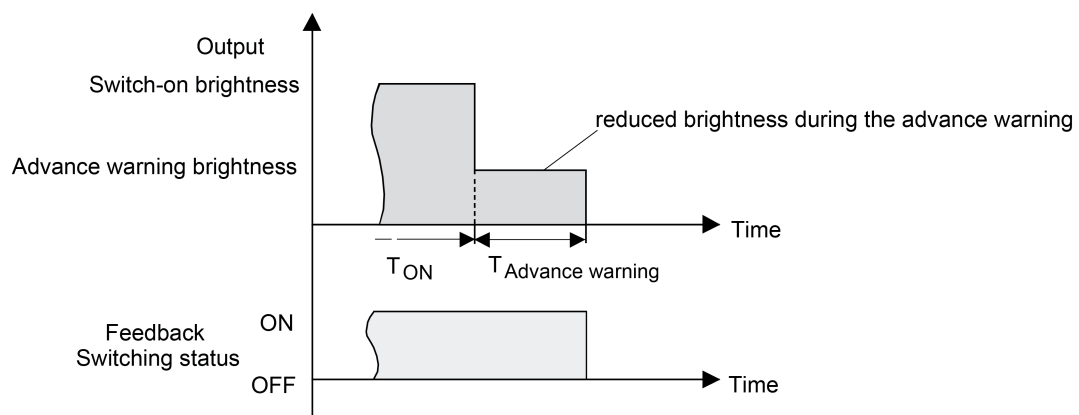

Figure 25: The pre-warning function of the staircase function without soft OFF function

Additionally, the pre-warning function can also be extended by the soft OFF function. Taking into account any soft OFF function, this gives rise to a modified switch-off behaviour of the staircase function after the pre-warning has elapsed (Figure 26).



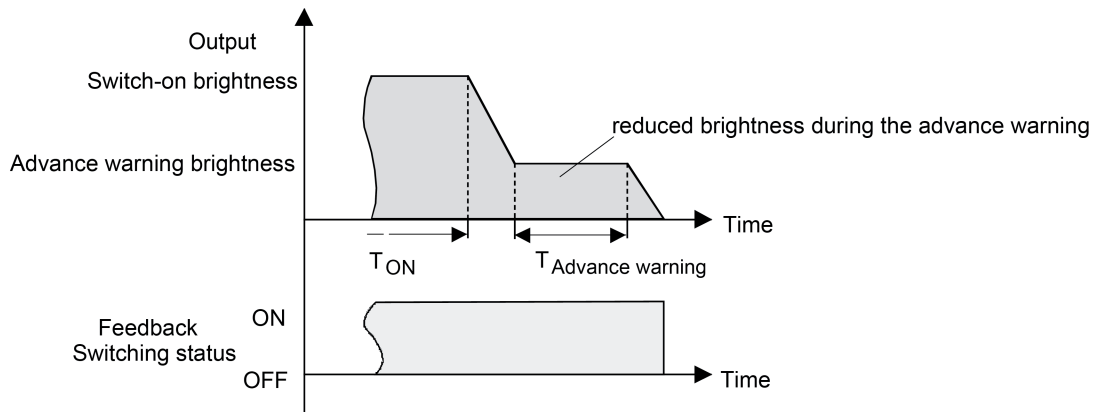

Figure 26: The pre-warning function of the staircase function with soft OFF function (for example with minimum brightness = 0 %)

- i** The pre-warning brightness does not necessarily have to be less than the switch-on brightness. The pre-warning brightness can always be configured to values between basic/minimum brightness and maximum brightness.

#### Precondition

The staircase function must be enabled.

- Set the parameter "Reaction at the end of the staircase time" on the parameter page "Ex – Staircase function" to "Activate pre-warning time".  
The pre-warning function is enabled. The desired pre-warning time ( $T_{\text{Vorwarn}}$ ) can be preset.
- Configure the "pre-warning time".
- Set the parameter "Reduced brightness during the pre-warning time (1...100 %)" to the desired brightness value.

During the pre-warning time, the dimming channel is set to the configured brightness value.

- i** The configured value for the reduced brightness must be greater than or equal to the minimum brightness (if configured) or less than or equal to the maximum brightness!
- i** An ON telegram to the object "Staircase function start/stop" while a pre-warning function is still in progress stops the pre-warning time and always starts (independently of the parameter "Staircase time retriggerable ?") the staircase time anew. Even during the pre-warning time, the parameter "reaction to OFF telegram" is evaluated so that a pre-warning in progress can be terminated early by switching off.
- i** Using the automatic switch-off function: The reduced brightness of the pre-warning does not start the switch-off function after reaching or undershooting the switch-off brightness.

#### Setting continuous lighting of the staircase function

At the end of the switch-on time of the staircase function, the actuator for the dimming channel concerned shows the "reaction at the end of the staircase time" configured in the ETS. The channel can be set to switch off immediately, alternatively to execute a pre-warning function, or to dim to reduced continuous lighting. The reduction of the lighting to continuous lighting after the staircase time has elapsed is appropriate, for example, if a certain degree of artificial light should be switched on permanently in long, dark hallways. Switching to switch-on brightness by activating the staircase function normally takes place by additional presence detectors or motion detectors when people are present in the hallway.

If the parameter "Reaction at the end of the staircase time" is configured to "activate reduced continuous lighting", the brightness for the continuous lighting can be configured in the ETS.

The continuous brightness is normally reduced in the brightness value compared to the switch-on brightness (Figure 27).

The continuous lighting remains permanently active after the staircase time has elapsed. Only when an ON telegram is received again via the object "Staircase function start/stop" does the actuator switch back to the switch-on brightness and start counting the staircase time again. The receipt of an OFF telegram via the object "Staircase function start/stop" only switches the continuous lighting off if the parameter "Reaction to OFF-telegram" is configured to "Switch off".

- i** A dimming channel can always be switched on and off via the "switching" object independently of the staircase function. Consequently, continuous lighting will also be overridden if telegrams arrive on the actuator via the "switching" object. If permanent continuous lighting is desired, which cannot be influenced by the "switching" object nor by the object of the staircase function, the disabling function of the actuator should be used.

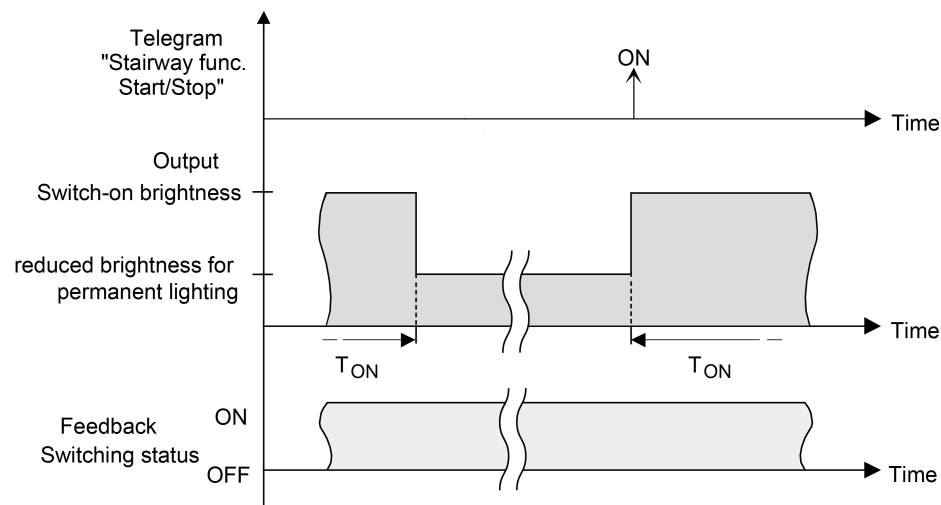

Figure 27: The continuous lighting of the staircase function without soft functions

Additionally, the continuous lighting can also be extended by the soft function. Taking into account any soft ON and soft function, this gives rise to modified continuous lighting behaviour of the staircase function (Figure 28).

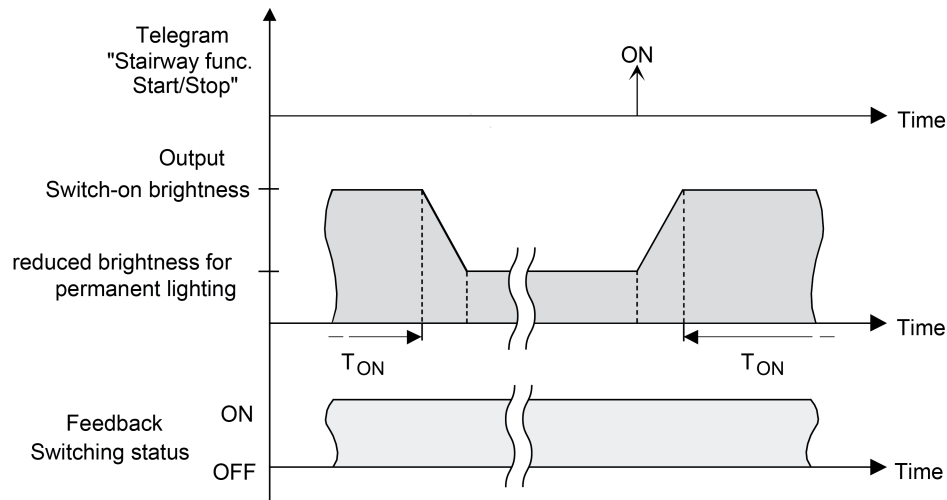

Figure 28: The continuous lighting of the staircase function with soft OFF functions

- i** The brightness of the continuous lighting does not necessarily have to be less than the switch-on brightness. The brightness of the continuous lighting can always be configured to values between basic/minimum brightness and maximum brightness.

#### Precondition

The staircase function must be enabled.

- Set the parameter "Reaction at the end of the staircase time" on the parameter page "Ex – Staircase function" to "Activate reduced continuous lighting".  
The continuous lighting is enabled. The "reduced brightness for continuous lighting (1...100 %)" can be set to the desired brightness value.
- i** The configured value for the reduced brightness must be greater than or equal to the minimum brightness (if configured) or less than or equal to the maximum brightness!
- i** An ON telegram to the object "Staircase function start/stop" always starts (independently of the parameter "Staircase time retriggerable?") the staircase time anew. Even during activated continuous lighting, the parameter "Reaction to OFF telegram" is evaluated so that continuous lighting can be switched off.
- i** Using the automatic switch-off function: The reduced brightness of the continuous lighting does not start the switch-off function after reaching or undershooting the switch-off brightness.

#### Setting supplementary function of the staircase function – time extension

With the time extension function, the staircase time can be retriggered several times (i.e. extended) via the "Staircase function start/stop" object. The duration of the extension is predefined by several operations at the control section (several ON telegrams in succession). The configured staircase time can be extended in this way by the configured factor (a maximum of 5-fold). The time is then always extended automatically at the end of a single staircase time ( $T_{EIN}$ ).

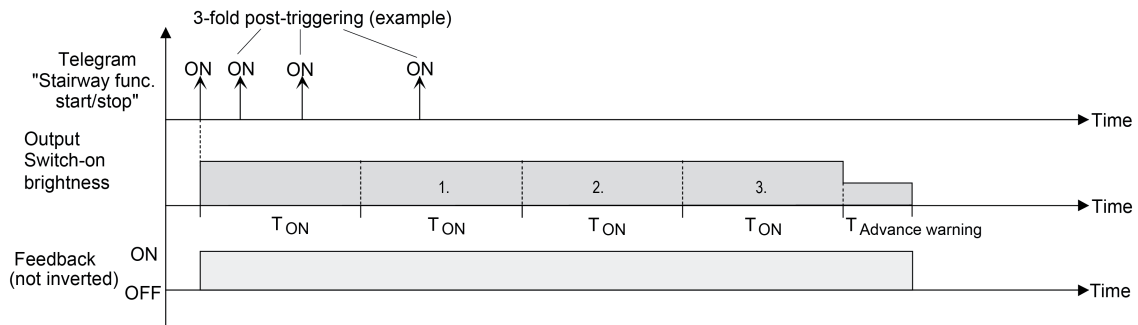

Figure 29: Time extension of the staircase function

With this function, the lighting time in a staircase can be extended (e.g. by a person after shopping) by a defined length without having to retrigger the lighting every time the lighting shuts off automatically.

The staircase function must have been enabled on parameter page "Ex – Enabled functions."

- Set the parameter "Supplementary function for staircase function" on the parameter page "Ex – Staircase function" to "time extension" and set the maximum desired factor on the parameter "maximum time extension".

The staircase time is retriggered each time an ON telegram is received on the "staircase time start/stop" object after the staircase time has elapsed, depending on the number of telegrams received, but only as often as pre-defined by the configured factor. For example, the "3-fold time" setting means that after the started staircase time has elapsed, it can be retriggered automatically a maximum of three additional times. The time is therefore extended a maximum of four fold (Figure 29).

- i** A time extension can be triggered during the entire staircase time ( $T_{EIN}$ ). There is no time limit between two telegrams for the time extension. Telegrams for the time extension are only evaluated during the staircase time. An ON telegram during the pre-warning function or continuous lighting triggers the staircase time as a restart, which means that a new time extension is possible.
- i** If a time extension was configured as a supplementary function, the parameter "Staircase time retriggerable ?" is preset to "no" because the retriggering takes place by the time extension.

### Setting supplementary function of the staircase function – time preset via the bus

With the time preset via the bus, the configured staircase time can be multiplied by an 8-bit factor received via the bus, thus it can be adapted dynamically. With this setting, the factor is derived from the object "staircase time factor". The possible factor value for setting the staircase time is between 1...255.

The entire staircase time arises as a product from factor (object value) and the configured staircase time as a basis as follows...

$$\text{Staircase time} = (\text{staircase time object value}) \times (\text{staircase time parameter})$$

Example:

Object value "staircase time factor" = 5; parameter "staircase value" = 10s.

-> set staircase time = 5 x 10s = 50 s

Alternatively, the staircase function parameter can define whether the receipt of a new factor also starts the staircase time of the staircase function at the same time. In this case, the object "Staircase function start/stop" is not necessary and the received factor value determines the starting and stopping.

## Precondition

The staircase function must have been enabled on parameter page "Ex – Enabled functions.

- Set "supplementary function for staircase function" on the parameter page "Ex – Staircase function" to "time preset via the bus" and set the parameter "staircase function activatable via 'staircase time' object ?" to "no".

The staircase time can be adapted dynamically by the "staircase time factor" object. A value "0" is interpreted as value "1". The staircase function is started and stopped exclusively via the "staircase function start / stop" object.

- Set "supplementary function for staircase function" on the parameter page "Ex – Staircase function" to "time preset via the bus" and set the parameter "staircase function activatable via 'staircase time' object ?" to "yes".

The staircase time can be adapted dynamically by the "staircase time factor" object. In addition, the staircase function is started with the new staircase time (the "staircase function start / stop" is not necessary) after receiving a new factor. A factor value "0" is interpreted as an OFF telegram, whereby in this case, the configured reaction to an OFF telegram is evaluated, too.

A larger staircase with several floors is an example as an application for the time preset via the bus with automatic starting of the staircase time. On each floor there is a push-button sensor that transmits a factor value to the staircase function. The higher the floor, the greater the factor value transmitted so that the lighting stays switched on longer if the passing through the staircase needs more time. When a person enters a staircase and a pushbutton is pressed, the staircase time is now adjusted dynamically to the staircase time and switches on the lighting at the same time, too.

- i** Setting "Staircase function activatable via"Staircase time" object ?" = "yes":  
A factor > 0 received during a warning time triggers the staircase time independently of the parameter "staircase time retriggerable ?" always afterwards.
- i** After a reset (bus voltage return or ETS programming) the "staircase time factor" object is always initialised with "1". The staircase function is not started automatically solely as the result of this, however.
- i** The two supplementary functions "time extension" and "time preset via the bus" can only be configured alternatively.

## Setting the behaviour of the staircase function after bus voltage return

The staircase function can optionally be started automatically after bus voltage return.

### Precondition

The staircase function must have been enabled on parameter page "Ex – Enabled functions.

- Set the parameter "Behaviour after bus voltage return" on the parameter page "Ex – General" to "activate staircase function".

Immediately after bus voltage return, the staircase time of the staircase function is started.

- i** The configured behaviour will only be executed, if no forced position on bus voltage return is activated.

## 4.2.4.2.10 Scene function

### Functional description

Up to 10 scenes can be programmed and scene values stored separately in the actuator for each dimming channel. The scene values are recalled or stored via a separate scene extension object. The data point type of the extension object permits addressing of a maximum of 64 scenes. This means that, in the configuration of a scene, it is possible to specify which scene number (1...64) contacts the internal scene (1...10).

The scene function must be enabled on parameter page "Ex - Enabling functions" for each dimming channel in order for the required communication objects and parameters (on the parameter page "Ex - Scene function") to be visible.

The scene function can be combined together with other functions of a dimming channel, whereby the last received or preset state is always executed:

Telegrams to the "switching", "dimming" or "brightness value" objects, a scene recall or scene storage telegram at the time of an active staircase function aborts the staircase time prematurely and presets the brightness state according to the received object value (time delays are also taken into account) or scene value. Likewise, the brightness state of the dimming channel, which was preset by the "switching", "dimming" or "brightness value" objects or by a scene recall, can be overridden by a staircase function.

### Presetting a scene recall delay for the scene function

Each scene recall of a dimming channel can optionally also be delayed. With this feature, dynamic scene sequences can be configured if several scene output channels are combined with cyclical scene telegrams.

#### Precondition

The scene function must be enabled on parameter page "Ex - Enabled functions".

- Set the parameter "Delay scene recall?" on the "Ex - Scene function" parameter page to "yes".

The delay time is now activated and can be configured separately. The delay only influences the scene recall of the dimming channel. The delay time is started on arrival of a recall telegram. The corresponding scene will be recalled and the brightness value set on the dimmer output only after this time has elapsed.

- i** Each scene recall telegram restarts the delay time and retriggers it. If a new scene recall telegram is received while a delay is active (scene recall not yet executed), the old (and not yet recalled scene) will be rejected and only the scene last received executed.
- i** The scene recall delay has no influence on the storage of scene values. A scene storage telegram within a scene recall delay terminates the delay and thus the scene recall.

### Setting behaviour when recalling a scene

In the scene configuration of a dimming channel, it is possible to define whether the light intensity instantly jumps or dims to the scene brightness value. When dimming, it can also be predefined whether the dimming procedure should be executed normally by dimming increments or by fading. A scene recall can therefore be executed independent of the set dimming behaviour and dimming characteristic of an output.

The behaviour during a scene recall can be configured separately for each scene.

#### Precondition

The scene function must be enabled on parameter page "Ex - Enabled functions".

- Set the parameter "Behaviour when recalling a scene" on parameter page "Ex - Scene function" to "Jump to brightness value".

The scene brightness values are instantly jumped to during a recall.

- Set the parameter "Behaviour when recalling a scene" to "Dim to brightness value via dimming increment time". At the same time, define the required "dimming increment time (0...255 ms)" to dim to the scene brightness value.  
The scene brightness values of the scene concerned are dimmed to during a recall. The time in the parameter selection defines the duration of the dimming procedure between 2 of 255 dimming increments.
- Set the parameter "Behaviour when recalling a scene" to "Dim to brightness value via fading". At the same time, define the "fading time (0...240 ms)" required to dim to the scene brightness value.  
The scene brightness values of the scene concerned are dimmed to during a recall. The dim fading is activated. The time in the parameter selection defines the duration of the dimming procedure required to reach the scene brightness value. The brightness value of a dimming channel at which the dimming starts and the configured dimming characteristic have no significance. Thus, the dimming procedure in case of a scene recall always requires the exact predefined time.

### Presetting the ETS download behaviour for the scene function

During storage of a scene, the scene values are stored internally to non-volatile memory in the device. To prevent the stored values from being replaced during ETS programming of the application or of the parameters by the originally programmed scene brightness values, the actuator can inhibit overwriting of the scene values. As an alternative, the original values can be reloaded into the device during each programming run of the ETS.

#### Precondition

The scene function must be enabled on parameter page "Ex - Enabled functions".

- Set the parameter "Overwrite the values stored in the device during ETS download?" on the parameter page "Ex - Scene function" to "yes".  
During each ETS programming of the application or of the parameters, the scene values parameterized in the ETS for the dimming channel concerned will be programmed into the actuator. Scene values stored in the device by means of a storage function will be overwritten, if any.
  - Set the parameter "Overwrite values stored in the device during ETS download?" to "no".  
Scene values stored in the device with a storage function will be maintained. If no scene values have been stored, the brightness values last programmed in the ETS remain valid.
- i** When the actuator is commissioned for the first time, this parameter should be set to "Yes" so that the dimming channel is initialised with valid scene values.

### Presetting scene numbers and scene brightness values for scene function

The datapoint type of the scene extension object permits addressing of up to 64 scenes max. For this reason, the scene number (1...64) with which the scene is addressed, i.e. recalled or stored, must be determined for each internal scene (1...10) of the dimming channel. Moreover, the brightness value to be set for the dimming output in case of a scene recall must be specified as well.

#### Precondition

The scene function must be enabled on parameter page "Ex - Enabled functions".

- Set the parameter "Scene x activatable by scene number" (x = number of the scene (1...10)) for each scene on parameter page "Ex - Scene function" to the numbers with which the scenes are to be addressed.  
A scene can be addressed with the configured scene number. A setting of "0" deactivates the corresponding scene so that neither recalling nor storage is possible.

- i** If the same scene number is parameterized for several scenes, only the scene with the lowest internal scene number (1...10) will be addressed. The other internal scenes will be ignored in this case.
  - Set the parameter "Brightness value for scene x" (x = number of the scene (1...10)) on parameter page "Ex – Scene function" for each scene to the desired brightness value.  
During a scene recall, the parameterized brightness value is recalled and set on the dimming channel.
- i** The parameterized brightness value is adopted in the actuator during programming with the ETS only if the parameter "Overwrite values stored in the device during ETS download?" is set to "yes".
- i** It should be noted that the configured value for the scene brightness is greater than a configured minimum brightness (if applicable) and less than the set maximum brightness!

### Presetting the storage behaviour for the scene function

The brightness value preset for the dimming channel can be stored internally via the extension object on reception of a scene storage telegram – also during a dimming procedure. In this case, the brightness value can be influenced before the storage by all functions of the dimming channel provided the individual functions have been enabled (e.g. also the disabling function, forced-control position function etc.).

#### Precondition

The scene function must be enabled on parameter page "Ex - Enabled functions".

- Set the parameter "Storage function for scene x" (x = number of the scene (1...10)) on parameter page "Ex – Scene function" for each scene to "Yes".  
The storage function is activated for the scene in question. On reception of a storage telegram via the "Scene extension" object, the current brightness value will be internally stored.
- Set the parameter "Storage function for scene x" (x = number of the scene (1...10)) to "No" for each scene.  
The storage function is deactivated for the scene in question. A storage telegram received via the "scene extension" object will be rejected.

### Configure extended scene recall

The extended scene recall allows polling of the 10 scenes of the dimming channel in sequence. Here, scene recall takes place via the 1-bit communication object "Extended scene recall". Each ON telegram received via this object recalls the next scene. Each OFF telegram received recalls the previous scene.

With the extended scene recall, the actuator always recalls the neighbouring scene - starting with the scene most recently recalled via the extended recall. It is irrelevant whether the scene is active on the appropriate dimming channel (assigned scene number = "1...64") or inactive (assigned scene number = "0"). If an inactive scene is recalled via the extended scene recall, the appropriate dimming channel will not react.

After a reset (bus voltage return, ETS programming operation), an ON or OFF telegram always recalls scene 1 first.

- i** Recall of a scene via the 1-byte extension object does not influence the scene sequence of the extended scene recall. The two recall functions work independently of each other.
  - Set the parameter "Use extended scene recall?" on the parameter page "Ex - Scene function" to "Yes".  
The object "Extended scene recall" is available. Each ON telegram recalls the next scene. Each OFF telegram recalls the previous scene.
  - Set the parameter "Use extended scene recall?" to "no".



The extended scene recall is deactivated. A scene recall can only take place via the 1-byte scene extension object.

The extended scene recall can take place with or without an overflow at the scene limits. An overflow occurs when scene 10 is reached when counting up or scene 1 when counting down and an additional telegram in the last counting direction is received by the actuator. The overflow behaviour is defined in the ETS.

- Set the parameter "Use extended scene recall with overflow?" to "yes".  
After reaching scene 10, a further ON telegram of the overflow is executed and scene 1 recalled. In the same way, after reaching scene 1, a further OFF telegram of the overflow is executed and scene 10 recalled.
- Set the parameter "Use extended scene recall with overflow?" to "no".  
A scene overflow is not possible. After reaching scene 10, further ON telegrams of the extended scene recall are ignored. In the same way, the actuator ignores further OFF telegrams if scene 1 was recalled last.

## 4.2.4.2.11 Burn-in function

### Functional description

If necessary, the burn-in function allows the commissioning of new fluorescent lamps as required by manufacturers. The burn-in function ensures that the connected luminaires are operated in switched-on mode for a defined period of time at full brightness, irrespective of the brightness specification. This provides basic stability of fluorescent lamps, offering their full lifespan subject to the electrical and light values described by the manufacturer. Observe the lamp manufacturer's instructions for the duration of the burn-in phase. The control unit allows burn-in phases with lengths of 1...100 hours. The burn-in period is configured individually in the ETS for each dimming channel.

If the burn-in function is active, switch-on commands and brightness values in the range 1...100 % (1...255) cause the dimming channel always to switch on at 100 % brightness. Switch-off commands and brightness values of 0 % lead to the switch-off of a dimming channel. In consequence, if the burn-in function is active, no continuous brightness values between 0 % and 100 % can be set. Dimming operations are not possible.

The burn-in function possesses the highest function priority of a dimming channel. Thus, active burn-in overrides all the other channel functions for continuous brightness specification (e.g. disabling function, staircase function) and also the normal KNX activation via dimming and brightness commands.

Overridden functions continue to be processed within the actuator, so that, brightness values can be tracked after the expiry of the intended burn-in period or on cancelling or pausing the burn-in function.

**i** Due to the higher priority, the burn-in function overrides the configured maximum brightness.

### Enable burn-in function

In order to be able to use the burn-in function, it has to be enabled in the ETS configuration.

- On the parameter page "Ex - Enabled functions", set the "Burn-in function" parameter to "Enabled".

The burn-in function is enabled. Further parameters become visible on the parameter page "Ex - Burn-in function".

### Start and stop burn-in function

During operation of the control unit, the burn-in function of a dimming channel can, if necessary, be started and stopped using a 1-bit communication object, e.g. when exchanging a lamp. Alternatively, automatic starting after an ETS programming operation can be selected.

#### Precondition

The burn-in function must have been enabled on parameter page "Ex - Enabled functions".

- Set the parameter "Set and stop burn-in function via object?" on the "Ex - Burn-in function" parameter page to "No".

After a successful ETS programming operation, the burn-in function is immediately active with the configured burn-in period. Each ETS programming operation restarts the burn-in function with the remaining residual time. A fully elapsed burn-in period is restarted by a new ETS programming operation.

After a bus voltage return, a burn-in function active at the time of a bus voltage failure is continued with the remaining burn-in period.

**i** The value of the remaining burn-in time is saved to the hour on a bus voltage failure.

- Set the parameter "Set and stop burn-in function via object?" to "yes".

The burn-in function must be activated with an "ON" telegram via the object "Start/stop burn-in function". Each start operation triggers a new burn-in phase with the configured burn-in period.

If the burn-in function is stopped early through an "OFF" telegram, then the brightness value tracked for the dimming channel is set and the residual burn-in period is deleted.

After a device reset (bus voltage failure, ETS programming operation), the "Start/stop burn-in function" object contains the "OFF" state. In consequence, an active burn-in function is stopped early by a bus voltage failure or ETS programming operation.

## Pause burn-in function

It is possible to pause an active burn-in period as required. The pause is triggered and terminated by a separate 1-bit object.

### Precondition

The burn-in function must have been enabled on parameter page "Ex - Enabled functions".

- Set the parameter "Pause burn-in function via object?" on the "Ex - Burn-in function" parameter page to "No".

The pause function is not available.

- Set the parameter "Pause burn-in function via object?" on the "Ex - Burn-in function" parameter page to "Yes".

An "ON" telegram to the "Pause burn-in function" object interrupts an active burn-in function. The brightness value tracked for the dimming channel is set. The residual burn-in period remains intact.

An "OFF" telegram lifts the pause and continues the execution of the burn-in function with the remaining residual time.

- i** After a device reset (bus voltage failure or ETS programming operation), the "Pause burn-in function" object contains the "OFF" state. In consequence, an active pause is always stopped by a bus voltage failure or ETS programming operation.

## Configure feedback of the current burn-in period

Optionally, a separate 1-byte object can be used to feed back the remaining residual time up to the end of the burn-in function or, alternatively, the burn-in time that has elapsed since the start, to the bus.

### Precondition

The burn-in function must have been enabled on parameter page "Ex - Enabled functions".

- On the parameter page "Ex - Burn-in function", set the parameter "Feedback of current burn-in period" to "Remaining time".

The "Burn-in function duration" object becomes visible. It feeds back the remaining residual time of a burn-in phase in the data format "Hours". If the burn-in function is stopped, the object contains the value of the full burn-in period. With a paused function, the object contains the saved value of the residual time of the current burn-in phase.

- Set the parameter "Feedback of current burn-in period" to "Elapsed time".

The "Burn-in function duration" object becomes visible. It feeds back the elapsed time of a burn-in phase in the data format "Hours". If the burn-in function is stopped, the object contains the value "0 h". With a paused function, the object contains the saved value of the elapsed time of the current burn-in phase.

- Set the parameter "Feedback of current burn-in period" to "No feedback".

The feedback function of the burn-in period is deactivated. The "Burn-in function duration" object is invisible.

The object "Burn-in function period" can work as an active signalling object, or alternatively, as a passive status object.

#### Precondition

The "Burn-in function duration" object must be visible.

- On the parameter page "Ex - burn-in function", set the parameter "Feedback type" to "Active signalling object".

The length of the burn-in function (remaining or elapsed time) is transmitted as soon as the object value is updated by the actuator. Automatic telegram transmission of the feedback takes place after bus voltage return or after an ETS programming operation (if a delay after bus voltage return is configured, only after the delay time has elapsed).

- On the parameter page "Ex - Burn-in function", set the parameter "Feedback type" to "Passive status object".

The length of the burn-in function is only transmitted as a response when the "Burn-in function duration" object is read out by the bus. No automatic telegram transmission takes place after bus voltage return or after an ETS programming operation.

The object "Burn-in function duration" is updated when the feedback value changes. In addition, the object value can be transmitted cyclically, if the object is configured as actively transmitting.

#### Precondition

The "Burn-in function duration" object must be an actively transmitting object.

- Configure the parameter "Cycle time for feedback" on the parameter page "Ex - Burn-in function" to the required time value.

In the settings "1...255 minutes", cyclical transmission is active.

In the "0 minutes" setting, cyclical transmission is deactivated. The feedback object only then transmits a telegram if there is a change.

## 4.2.4.2.12 Supplementary function

### Functional description

Supplementary functions can be enabled for each dimming channel. As a supplementary function, a disabling or alternatively a forced position function can be configured. In this respect, only one of these functions can be enabled for one dimming channel. Additionally, a logic operation function can be parameterized.

The supplementary functions are enabled and configured on parameter page "Ex – Supplementary functions".

### Setting disabling function as supplementary function

During an active disabling function, the KNX control of the dimming function concerned is overridden and locked. Continuous light switching, for example, can also be overridden.

- On the parameter page "Ex - supplementary functions", set the parameter "type of supplementary function" to "disabling function".

The disabling function is enabled. The communication object "Disable" and the parameters of the disabling function become visible.

- On the parameter page "Ex - supplementary functions", set the parameter "polarity disabling object" to the desired polarity.
- Set the parameter "Behaviour at the beginning of the disabling function" to the required behaviour.

At the beginning of the disabling function, the configured behaviour will be executed and the bus control of the dimming channel locked.

In the "No reaction" setting, the control voltage remains the same and the relay is switched to the most recently switching state defined by bus operation. This ensures that relays altered by a manual operation are in the right switching state. If the relays are already in the correct position, then the actuator does not react.

In the "flashing" setting, the dimming channel is switched on and off cyclically during the disabling. The "Time for flashing" is generally configured on the parameter page "Times". During flashing, the logical switching state of the dimming channel is signalled back as "switched on" and the brightness value as "switch-on brightness". A soft ON/OFF function is not executed during flashing.

In the "Memory value" setting, the active and internally saved brightness value prior to switching off last time is set (via the "switching" or "central switching" object). After programming with the ETS, the value is predefined to maximum brightness. Only a bus voltage failure does not delete the memory value.

- Set the parameter "setting the behaviour at the end of the disabling function" to the required behaviour.

At the end of the disabling function, the configured behaviour will be executed and the bus control of the dimming channel enabled again.

In the "No reaction" setting, the brightness value and relay are moved to the state set at the beginning of disabling. If, during the disabling function, the relays were not moved manually, the actuator will not show any switching reaction. Otherwise, the relay switches to the specified position.

In "tracked brightness value", the set state received during the disabling function or adjusted before the disabling function can be tracked at the end of the disabling with the appropriate brightness value. Any time functions still in progress will also be taken into account if necessary.

In the "Flashing" setting, the dimming channel is switched on and off cyclically after the disabling. The flashing time is generally configured on the parameter page "Times". During flashing, the logical switching state of the channel is fed back as "switched on" and the brightness value as "switch-on brightness". A soft ON/OFF function is not executed during flashing. The flashing status remains active until another bus command is received and thereby predefines another brightness status.

In the "Memory value" setting, the active and internally saved brightness value prior to switching off last time is set (via the "switching" or "central switching" object). After programming with the ETS, the value is predefined to maximum brightness. Only a bus voltage failure does not delete the memory value.

- i** If, at the start or end of the disabling function a brightness value is configured, the selected value must not undershoot the set minimum brightness or exceed the maximum brightness in the ETS.
- i** After a bus failure or after programming the application or the parameters with the ETS, the disabling function is always deactivated (object value "0"). With the inverted setting "1 = enabled; 0 = disabled", a telegram update "0" must first be carried out after the initialisation until the disabling is activated.
- i** Updates of the disabling object from "activated" to "deactivated" do not produce a reaction.
- i** The relay of a dimming channel disabled via the KNX can still be operated manually.
- i** In the setting "tracked brightness value": During a disabling function, the overridden functions of the actuator (switching, dimming, brightness value, scenes) continue to be executed internally. Consequently, newly received bus telegrams are evaluated and time functions are triggered as well. At the end of the disabling, the tracked states are set.

### Setting forced position function as supplementary function

The forced position function can also be combined with other functions of a dimming channel. With an active forced position, functions with a lower priority are overridden so that the dimming channel concerned is locked.

The forced position function possesses a separate 2-bit communication object. The first bit (Bit 0) of the object "Forced position" indicates whether the dimming channel is switched off or switched on by force. If the dimming channel is switched on by force, an ETS parameter defines which brightness value it should be switched on to. The second bit (bit 1) activates or deactivates the forced-position state (see table below).

The behaviour of a dimming channel at the end of the forced-position function can be configured. In addition, the forced object can be initialised on bus voltage return.

Bit 1	Bit 0	Function
0	x	Forced position not active -> normal control
0	x	Forced position not active -> normal control
1	0	Forced position active: switch off
1	1	Forced position active: switch on to predefined brightness value

#### Bit coding of forced position

- On the parameter page "Ex - supplementary functions", set the parameter "type of supplementary function" to "forced position".

The forced position function is enabled. The communication object "forced position" and the parameter of the forced position function become visible.
- On the parameter page "Ex - Supplementary functions", configure the parameter "Behaviour for forced position 'active, switch on'" to the required behaviour that should be executed if a forced control is activated via the communication object.

When setting a brightness value, the dimming channel adjusts itself to the set brightness during a forced-position state. The forced brightness value selected must not exceed the maximum brightness configured in the ETS.

In the "No reaction" setting, the bus operation of the dimming channel is locked. The control voltage remains the same and the relay is switched to the most recently switching state defined by bus operation. This ensures that relays altered by a manual operation are in the right switching state. If the relays are already in the correct position, then the actuator does not react.

In the "Memory value" setting, the active and internally saved brightness value prior to switching off last time is set (via the "switching" or "central switching" object). After programming with the ETS, the value is predefined to maximum brightness. Only a bus voltage failure, however, does not delete the memory value.

- Set the parameter "Behaviour at the end of the forced position 'inactive'" to the required behaviour.

At the end of the forced position, the configured behaviour will be executed and the bus control of the dimming channel enabled again.

In the "No reaction" setting, the brightness value and relay are moved to the state set at the beginning of the restraint. If, during the forced position, the relays were not moved manually, the actuator will not show any switching reaction. Otherwise, the relay switches to the specified position.

With "Tracked brightness value", at the end of a forced position, the state received during the forced position function or adjusted before the function can be tracked with the appropriate brightness value. Any time functions still in progress will also be taken into account if necessary.

- i** The "Switch off behaviour for forced position 'active'" is preset to "Switch off".
- i** Updates of the forced position object from "Forced position active" to "Forced position active" while maintaining the switching status or from "Forced position inactive" to "Forced position inactive" show no reaction.
- i** A forcibly activated dimming channel via the KNX can be still be operated manually!
- i** In the setting "tracked brightness value" at the end of the forced position: During a forced position, the overridden functions of the actuator (switching, dimming, brightness value, scenes) continue to be executed internally. Consequently, newly received bus telegrams are evaluated and time functions are triggered as well. At the forced end, the tracked states are set.
- i** The current state of the forced position object will be stored in case of bus voltage failure.

- Set the parameter "behaviour after bus voltage return" to the required behaviour.

After bus voltage return, the configured state is transferred to the "Forced position" communication object. When a forced position is activated, the dimming channel is immediately activated and interlocked accordingly by forced control after bus voltage return until a forced control enable takes place via the bus. The parameter "Behaviour after bus voltage return" on the parameter page "Ex – General" will, in this case, not be evaluated for the dimming channel concerned.

In the "state before bus voltage failure" setting, the forced position state last selected and internally stored before bus voltage failure will be tracked after bus voltage return. An ETS programming operation deletes the stored state (reaction in that case same as with "no forced position active").

If the tracked state corresponds to "No forced position", the force-independent parameter "Behaviour after bus voltage return" (parameter page "Ex - General") will be executed on return of bus voltage. If the forced position is activated, the dimming channel is switched on to the brightness value predefined by the parameter "Switch on behaviour for forced position 'active'".

- i** After programming the application or parameters with the ETS, the forced position function is always deactivated (object value "0").

### Setting logic operation function as supplementary function

A logic function can be parameterized separately for each dimming channel. This function allows the logic operation of the "Switching" object state and an additional logic operation object. The state of the communication object for "switching" can also be evaluated with a time delay if a switch-on delay or switch-off delay is set.

The logic operation function can also be combined with other functions of a dimming channel. A combination with the staircase function is not possible, however.

The following logic operation types are configurable (Figure 30).

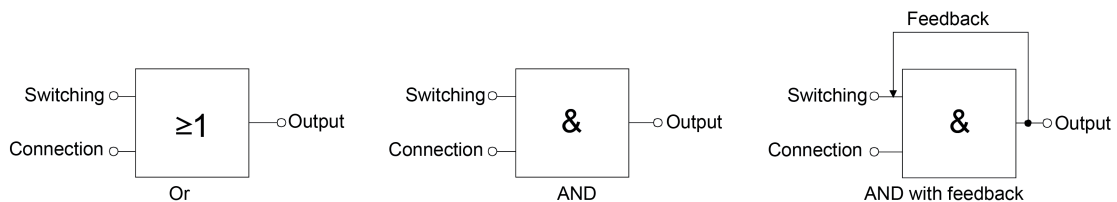

Figure 30: Logic operation types of the logic operation function

- i** "AND with feedback":  
With a logic object = "0", the dimming channel is always "0" (logic AND). In this case, the feedback signal from the output to the "switching" input will directly reset this input when it is being set. The output of the dimming channel can assume the logical state "1" by a newly received "1" on the input "switching" only when the logic object is = "1".

The object "Logic operation" can be installed with a configured value after bus voltage return or after programming with ETS so that a correct logic operation result can be determined immediately and set on the output of the dimming channel during a telegram update on the "Switching" object.

- On the parameter page "Ex - supplementary functions", set the parameter "Logic operation function?" to "yes".  
The logic operation function is enabled. The communication object "logic operation" and the parameters of the logic operation function become visible.
- Set the parameter "Type of logic operation function" to the desired logic operation type.
- Set the parameters "object value of the logic operation object after bus voltage return" and "object value of the logic operation object after ETS download" to the required initial states.  
The "logic operation" object is initialised immediately with the set switching states after bus voltage return or ETS programming of the application program or parameters.

- i** The logic operation function after a reset of the actuator (bus voltage return or ETS programming operation) is first executed when the switching object is updated as the input of the logic operation by at least one telegram.
- i** The states or switching states specified at the end of a disabling function or forced position function, which are set after programming in the ETS, in the case of bus voltage failure or after bus or mains voltage return, override the logic operation function. The configured logic operation is first re-executed and the result set on the output of the dimming channel when the switching object is updated as the input of the logic operation by at least one telegram.



## 4.2.4.3 Functional description of the independent switching channels

### 4.2.4.3.1 Function diagram and priorities

#### Function diagram

With the independent switching channels, various functions can be combined. Some functions are always available (e.g. switching and reset behaviour). Other functions can be optionally added to a switching channel (e.g. disabling function, staircase function). Processing of the channel functions takes place according to a specific sequence. This means that the functions influence each other.

The function diagram shows in which order the functions of a switching channel are processed (Figure 31).

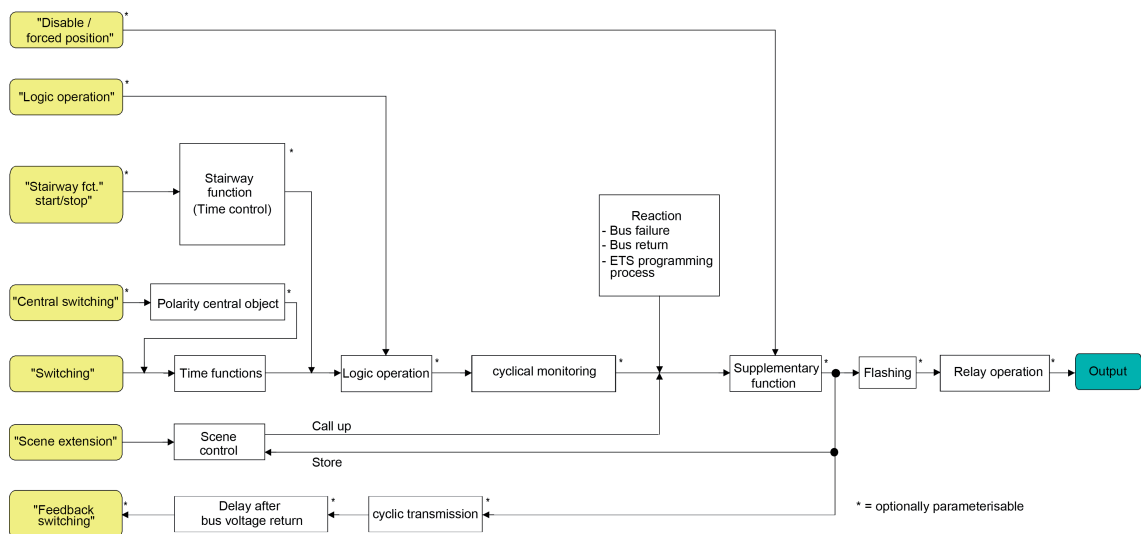

Figure 31: Function diagram of the switching channels

#### Priorities

Functions with a higher priority override other functions with a lower priority. In the same way as the function diagram, the descending function priorities of a switching channel are specified as follows:

1. Safe-state mode (see page 16)
2. Forced position / disabling function (see page 100)
3. Reset behaviour (see page 83)
4. Cyclical monitoring (see page 89)
5. Logical operation function / Staircase function (see page 91)
6. Normal operation (switching, scene / last command is performed)

## 4.2.4.3.2 Relay operating mode

### Setting the relay operating mode

The relays of an independent switching output can be configured as make or break contacts. In this way, the inversion of switching states is possible.

The parameter "Operating mode" exists separately for each switching channel on the parameter page "Ax - General".

- Set the operating mode to "NO contact".

The relay works as an NO contact. The logical switching status of the switching channel is forwarded to the relay in non-inverted form.

Switching state = OFF ("0") -> relay contact open,

Switching state = ON ("1") -> relay contact closed.

- Set the operating mode to "NC contact".

The relay works as an NC contact. The logical switching status of the switching channel is forwarded to the relay in inverted form.

Switching state = OFF ("0") -> relay contact closed,

Switching state = ON ("1") -> relay contact open.

- i** The logic switching state "ON" or "OFF" is set by the communication object "Switching" and influenced by the functions that can be optionally activated (e.g. timing/staircase functions, logic operations, disabling/forced-control position functions, scenes, central objects).
- i** The 1-bit feedback always feed back the logical switching state of the switching channels. Depending on the configured relay operating mode and an inverted or non-inverted evaluation, status feedback has the following meanings:
  - NO contact not inverted: Feedback = "ON" -> Relay closed, feedback = "OFF" -> Relay opened
  - NO contact inverted: Feedback = "ON" -> Relay opened, feedback = "OFF" -> Relay closed
  - NC contact not inverted: Feedback = "ON" -> Relay opened, feedback = "OFF" -> Relay closed
  - NC contact inverted: Feedback = "ON" -> Relay closed, feedback = "OFF" -> Relay opened
- i** Feedback of the current switching status via the "switching" object is not possible.

### 4.2.4.3.3 Response after a device reset

The switching states of the independent switching channels after a bus voltage failure, after bus voltage return or an ETS programming operation can be set separately.

#### Presetting the behaviour after ETS programming

The parameter "Behaviour after ETS programming" is available separately for each switching channel on the parameter page "Ax - General". This parameter can be used to configure the switching state of a channel, irrespective of the behaviour after bus voltage return.

- Set the parameter to "no reaction".

After an ETS programming operation, the relay is switched to the most recently switching state defined by bus operation. This ensures that relays altered by a manual operation are in the right switching state. If the relay is already in the correct position, then the actuator does not react.
- Set the parameter to "Open contact".

The relay contact is opened. If the relay is already in the correct position, then the actuator does not react.
- Set the parameter to "Close contact".

The relay contact is closed. If the relay is already in the correct position, then the actuator does not react.
- Set the parameter to "Behaviour as on bus voltage return".

After an ETS programming operation, the switching channel will behave in the manner defined in the parameter "Behaviour after bus voltage return". If the behaviour there is configured to "State as before bus voltage failure", then that switching state is also set after an ETS programming operation which was active at the time of the last bus voltage failure. An ETS programming operation does not overwrite the saved switching state.
- ⓘ The configured behaviour will be executed after every application or parameter download by the ETS. A simple download of the physical address alone or partial programming of only the group addresses has the effect that this parameter is disregarded and that the configured "Behaviour after bus voltage return" will be executed instead.
- ⓘ A switching state set after an ETS programming operation is added to the feedback object. Actively transmitting feedback objects also only first transmit after an ETS programming cycle when the initialisation has finished and, if necessary, the "delay time after bus voltage return" has elapsed.
- ⓘ After an ETS programming operation, the disabling functions and the forced-positions are always deactivated. The states of the forced position objects saved in case of the bus voltage failure are deleted.

#### Setting the behaviour in case of bus voltage failure

The parameter "Behaviour in case of bus voltage failure" is available separately for each switching channel on the parameter page "Ax - General".

- Set the parameter to "no reaction".

If there is a bus voltage failure, the relay is switched to the switching state most recently defined by bus operation. This ensures that relays altered by a manual operation are in the right switching state. If the relays are already in the correct position, then the actuator does not react.
- Set the parameter to "Open contact".

The relay contact is opened. If the relay is already in the correct position, then the actuator does not react.

- Set the parameter to "Close contact".  
The relay contact is closed. If the relay is already in the correct position, then the actuator does not react.
- ❗ Active disabling functions or forced position functions are cancelled and remain inactive until they are reactivated after a bus voltage return.
- ❗ In case of a bus voltage failure, the current states of the forced-positions are also saved so that they can be tracked on return of bus voltage if necessary (depending on the parameterization of the forced positions).
- ❗ In case of a bus voltage failure, the current switching states of all switching channels are saved internally, so that these states can be reset after bus voltage return, if this is configured in the ETS. The data is stored before the reaction configured for the case of bus voltage failure takes place and only if the power supply is still present, or if the supply fails completely after the bus voltage has been available before without interruption for at least 20 seconds after the last reset (storage capacitors sufficiently charged for storage purposes). In all other cases, nothing is stored (switching states = "OFF")!

### Setting the behaviour after bus voltage return

The parameter "Behaviour in case of bus voltage return" is created separately for each switching channel on the parameter page "Ax - General".

- Set the parameter to "no reaction".  
After a bus voltage return, the relay is brought into the state set on bus voltage failure (in accordance with the parameter "Behaviour on bus voltage failure"). If, during the bus failure, the relay was not moved manually, the actuator will not show any switching reaction. Otherwise, the relay switches to the specified position.
- Set the parameter to "Open contact".  
The relay contact is opened. If the relay is already in the correct position, then the actuator does not react.
- Set the parameter to "Close contact".  
The relay contact is closed. If the relay is already in the correct position, then the actuator does not react.
- Set the parameter to "State as before bus voltage failure".  
After bus voltage return, the switching state last set and internally stored before bus failure will be tracked.
- Preset parameter to "Activate staircase function". This setting is only available when the staircase function of the appropriate switching channel is enabled.  
The staircase function is – irrespective of the "Switching" object - activated after bus voltage return.
- ❗ Setting "State as before bus voltage failure": An ETS programming operation of the application or the parameter resets the stored switching state to "OFF".
- ❗ A switching state set after bus voltage return is tracked in the feedback objects. Actively transmitting feedback objects first transmit, however, after bus voltage return, when the initialisation of the actuator has finished, and if necessary the "Delay time after bus voltage return" has elapsed.
- ❗ In the case of forced position as supplementary function: The communication object of the forced position can be initialised separately after bus voltage return. This influences the reaction of the switching channel on an activation of the forced position on bus voltage return. The configured "Behaviour after bus voltage return" is only executed when no forced position after a bus voltage return is activated.

- i** In the case of enabling function as supplementary function: Active disabling functions are always inactive after bus voltage return.

## 4.2.4.3.4 Feedback for the switching status

### Functional description

The actuator can track the current switching state of a switching channel via a feedback object and can also transmit them to the bus. On each switching operation, the actuator determines the object value of the feedback. The actuator tracks the switching state and updates the feedback object even when a switching channel, for example, is activated by a supplementary function or scene function.

The switching status feedback object is updated after the following events...

- Immediately after switch-on of a switching channel (if necessary, first after a switch-on delay has elapsed / also after a staircase function).
- After switch-off of a switching channel (if necessary, only after a run-on-time has elapsed / also after a staircase function).
- During updating of the switching state from "ON" to "ON" or "OFF" to "OFF" when the switching channel is already switched on or off. However, only if the parameter "Update of the object value for switching status feedback" is configured to "On each update of obj. 'Switching'/Central".
- At the start or end of a disabling or forced position function, if a state changes as a result.
- Always on bus voltage return or at the end of any ETS programming process (if necessary, also delayed).

**i** An adjustment of the sliding switches of the relays is not detected by the application controller of the device. In consequence, even if the bus voltage is switched on, no feedback is transmitted on a manual actuation.

**i** In the case of enabling function as supplementary function: A "flashing" switching channel is always reported as "switched on".

### Activate switching status feedback

The switching status feedback can be used as an active message object or as a passive status object. As an active message object, the switching status feedback information is also directly transmitted to the bus whenever the feedback value is updated. As a passive status object, there is no telegram transmission after an update. In this case, the object value must be read out. The ETS automatically sets the object communication flags required for proper functioning. Optionally, the actuator can also feed back the status of an independent switching channel in inverted form.

The parameter "Feedback switching status?" is available separately for each switching channel on the parameter page "Ax - Feedback". Feedback takes place via the "Switching feedback" object.

Precondition:

The feedbacks must be enabled on parameter page "Ax - Enabled functions".

- Set the parameter to "no inversion, active signalling object".

A switching status is transmitted as soon as it is updated. An automatic telegram transmission of the feedback takes place after bus voltage return or after programming with the ETS. The switching status is written to the object in non-inverted form.

- Set the parameter to "no inversion, active signalling object".

A switching status will be transmitted in response only if the feedback object is read out from by the bus. No automatic telegram transmission of the feedback takes place after bus voltage return or after programming with the ETS. The switching status is written to the object in non-inverted form.

- Set the parameter to "Invert, active signalling object".

A switching status is transmitted as soon as it is updated. An automatic telegram transmission of the feedback takes place after bus voltage return or after programming with the ETS. The switching status is written to the object in inverted form.

- Set the parameter to "Invert, passive status object".  
A switching status will be transmitted in response only if the feedback object is read out from by the bus. No automatic telegram transmission of the feedback takes place after bus voltage return or after programming with the ETS. The switching status is written to the object in inverted form.
- Set the parameter to "no reaction".  
The switching status feedback of the affected switching channel is deactivated.
- i** Depending on the configured relay operating mode and an inverted or non-inverted evaluation, status feedback has the following meanings:  
NO contact not inverted: Feedback = "ON" -> Relay closed, feedback = "OFF" -> Relay opened  
NO contact inverted: Feedback = "ON" -> Relay opened, feedback = "OFF" -> Relay closed  
NC contact not inverted: Feedback = "ON" -> Relay opened, feedback = "OFF" -> Relay closed  
NC contact inverted: Feedback = "ON" -> Relay closed, feedback = "OFF" -> Relay opened
- i** Feedback of the current switching status via the "switching" object is not possible.

### Set update of "Switching feedback"

In the ETS, you can specify when the actuator should update the feedback value for the switching status (object "Switching feedback") in case of an actively transmitting communication object. The object value updated by the actuator is then signalled actively to the bus. The parameter "Update of the object value for feedback of switching status" can be preset separately for each switching channel on the parameter page "Ax - Feedback".

Precondition:

The feedbacks must be enabled on parameter page "Ax - Enabled functions". The feedbacks must be enabled on parameter page "Ax - Enabled functions". In addition, the switching status feedback must be configured to actively transmitting.

- Set the parameter to "after each update obj. 'Switching'/'Central'".  
The actuator updates the feedback value in the object once a new telegram is received on the input objects "Switching" or "Central switching" or the switching state changes internally (e.g. through a time function). With an actively transmitting feedback object, a new telegram is also then actively transmitted to the bus each time. The telegram value of the feedback does not necessarily have to change in the process. Hence, a corresponding switching status feedback is also generated on the "Switching" object such as in the case of cyclical telegrams for example.
- Set the parameter to "Only if the feedback value changes".  
The actuator only updates the feedback value in the object if the telegram value (e.g. "OFF" to "ON") also changes or the switching state changes internally (e.g. through a time function). If the telegram value of the feedback does not change (e.g. in the case of cyclical telegrams to the "Switching" object with the same telegram value), the actuator does not transmit any feedback. Consequently, with an actively transmitting feedback object, no telegram with the same content will be transmitted repeatedly either. This setting is recommendable, for instance, if the "Switching" and "Switching feedback" objects are linked to an identical group address. This is often the case when activating by means of light scene push-button sensors (recall and storage function).

### Setting switching status feedback on bus voltage return or after programming with the ETS

If used as active message object, the switching status feedback states are transmitted to the bus after bus voltage return or after programming with the ETS. In these cases, the feedback telegram can be time-delayed with the delay being preset globally for all switching channels together.

- Set the parameter "Time delay for feedback after bus voltage return?" on parameter page "Ax - Feedback" to "Yes".  
The switching status telegram is transmitted with a delay after bus voltage return or after an ETS programming operation. No feedback telegram is transmitted during a running delay, even if the switching state changes during this delay.
- Set the parameter "Time delay for feedback after bus voltage return?" to "no".  
The switching status telegram is transmitted immediately after bus voltage return or after an ETS programming operation.

### Setting cyclical transmission of the switching status feedback telegram

The switching status feedback telegrams can, if active, also be transmitted cyclically, in addition to the transmission after updating.

- Set the parameter "Cyclical transmission of feedback telegram?" on parameter page "Ax - Feedback" to "Yes".  
Cyclical transmission is activated.
  - Set the parameter "Cyclical transmission of feedback telegram?" to "no".  
Cyclical transmission is deactivated so that the feedback is transmitted to the bus only when updated by the actuator.
- i** The cycle time is defined centrally for all switching channels on the parameter page "Times".
- i** During an active delay after bus voltage return no feedback telegram will be transmitted even if a switching state changes.



## 4.2.4.3.5 Cyclical monitoring

### Functional description

The actuator offers the option of monitoring individual switching channels cyclically for the arrival of switching telegrams. In this way, the objects which must be updated cyclically by the KNX can be monitored. In so doing, the polarity of the telegram update ("0" or "1") is insignificant.

If there is no update of the monitored objects within a specifically configured monitoring time, then the affected switching channels set themselves to the preferred predefined contact position. However, this does not disable the channels, so that, after the reception of a further switching telegram, the new switching state is set at the output.

The monitoring time is specified globally for all switching channels on the parameter page "Times" through the parameter "Time for cyclical monitoring". However, each switching channel possesses its own time controllers so that the configured monitoring time is evaluated independently of the channel.

The time is restarted for a switching channel after each reception of a switching telegram via the objects "Switching" or "Central switching" (if at least one central function is assigned to the affected switching channel). The monitoring time is also restarted automatically after bus voltage return or after an ETS programming operation.

### Activate cyclical monitoring

The cyclical monitoring function can be activated separately for each switching channel with the parameter "Assignment to cyclical monitoring ?" on parameter page "Ax – Enabled functions". If the function is activated, as soon as the monitoring time elapses without having received a telegram update, the actuator sets the preference period for the appropriate switching channel after the time has elapsed.

- Set the parameter to "no".  
Cyclical monitoring is deactivated.
- Set the parameter to "Yes, 'ON' when time has elapsed".  
Cyclical monitoring is activated. After the time has elapsed, the switching channel is switched on.
- Set the parameter to "Yes, 'OFF' when time has elapsed".  
Cyclical monitoring is activated. After the time has elapsed, the switching channel is switched off.

**i** If cyclical monitoring is activated, the following functions cannot be configured: Time delays, staircase function, logic operation and scene.

**i** If a switching channel is already in its preferred state when the monitoring time elapses, no feedback is transmitted. However, the actuator activates the relay. This ensures that relays altered by a manual operation are in the right switching state. If the relay is already in the correct position, then the actuator does not show a switching reaction.

**i** The disabling and forced position function has a higher priority than the cyclical monitoring.

## 4.2.4.3.6 Timing functions

### Functional description

Up to two time functions can be preset for each independent switching channel, independently of each other. The time functions affect the communication objects "Switching" or "Central switching" only (if at least one of the central functions is activated for the channel concerned) and delay the object value received depending on the telegram polarity.

### Activating switch-on delay

The switch-on delay can be activated separately in the ETS for each switching channel.

Precondition:

The timing functions must be enabled on parameter page "Ax - Enabled functions".

- Set the parameter "Selection of time delay" to "Switch-on delay" or to "Switch-on delay and switch-off delay". Configure the desired switch-on delay.

The switch-on delay is enabled. After reception of an ON telegram via the "switching" object, the configurable time is started. Another ON-telegram triggers the time only when the parameter "Switch-on delay retriggerable" is set to "yes". An OFF-telegram received during the ON-delay will end the delay and sets the switching status to "OFF".

### Activating switch-off delay

The switch-off delay can be activated separately in the ETS for each switching channel.

Precondition:

The timing functions must be enabled on parameter page "Ax - Enabled functions".

- Set the parameter "Selection of time delay" to "Switch-off delay" or to "Switch-on delay and switch-off delay". Configure the desired switch-off delay.

The switch-off delay is enabled. After reception of an OFF-telegram via the "switching" object, the configurable time is started. Another OFF-telegram triggers the time only when the parameter "switch-off delay retriggerable?" is set to "yes". An ON-telegram received during the OFF-delay will end the delay and sets the switching status to "ON".

- i** At the end of a disabling function or forced position function, the switching state received during the function or set before the function can be tracked. Residual times of time functions are also tracked if these had not yet fully elapsed at the time of the reactivation or forced control.
- i** The time delays do not influence the staircase function if this is enabled.
- i** A time delay still in progress will be fully aborted by a reset of the actuator (bus voltage failure or ETS programming).

## 4.2.4.3.7 Staircase function

### Functional description

The staircase function can be used for implementing time-controlled lighting of a staircase or for function-related applications. The staircase function must be enabled in the ETS on parameter page "Ax - Enabling functions" in order for the required communication objects and parameters to be visible.

The staircase function is activated via the communication object "staircase function start / stop" and is independent of the "switching" object of a switching channel. In this way, parallel operation of time and normal control is possible, whereby the command last received is always executed: A telegram to the "switching" object or a scene recall at the time of an active staircase function aborts the staircase time prematurely and presets the switching state according to the received object value (the time delays are also taken into account) or scene value. Likewise, the switching state of the "switching" object can be overridden by a staircase function.

Time-independent continuous light switching can also be implemented in combination with a disabling function because the disabling function has a higher priority and overrides the switching state of the staircase function.

The staircase function can also be extended by means of a supplementary function. At the same time, it is possible to activate a time extension. The "time extension" permits retriggering of an activated staircase via the object "Staircase function Start / Stop" n times. Alternatively, the "Time preset via the bus" can be set. With this supplementary function, the configured staircase time can be multiplied by a factor received via the bus, thus it can be adapted dynamically. Furthermore, an extension of the staircase function can be implemented by means of a separate switch-on delay and pre-warning function. The pre-warning should, according to DIN 18015-2, warn any person still on the staircase that the light will soon be switched off.

### Specifying switch-on behaviour of the staircase function

An ON telegram to the "Staircase function start/stop" object activates the staircase time ( $T_{ON}$ ), the duration of which is defined by the "Staircase time" parameters. In addition, a switch-on delay ( $T_{Verz}$ ) can be activated (see "presetting switch-on delay of the staircase function"). At the end of the staircase time, the output switches off or activates optionally the pre-warning time ( $T_{Vorwarn}$ ) of the pre-warning function (see "presetting pre-warning function of the staircase function"). Taking into account any possible switch-on delay and pre-warning function, this gives rise to the switch-on behaviour of the staircase function as shown in the following diagram.

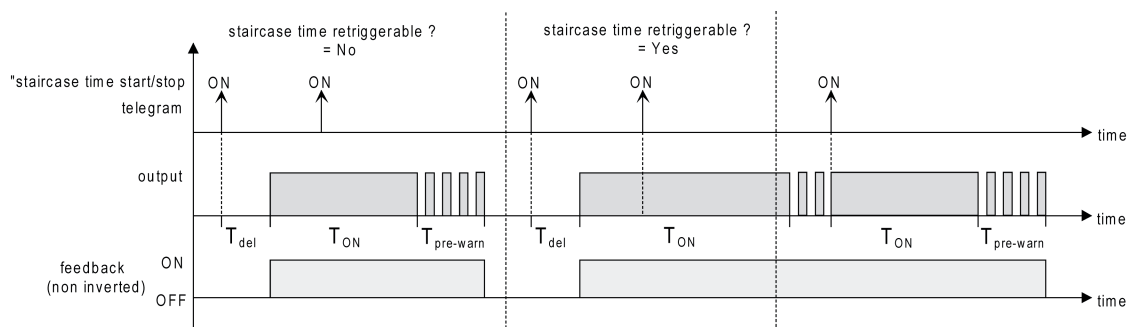

Figure 32: Switch-on behaviour of the staircase function

The parameter "Staircase time retriggerable" specifies whether the staircase time can be retriggered.

Precondition:

The staircase function must have been enabled on parameter page "Ax – Enabled functions".

- Set the parameter "Staircase time retriggerable" to "Yes".

Every ON telegram received during the ON phase of the staircase time retriggers the staircase time completely.

- Set the parameter "Staircase time retriggerable" to "No".  
ON telegrams received during the ON phase of the staircase time are rejected. The staircase time is not retriggered.
- ❗ An ON telegram received during the pre-warning time always retriggers the staircase time independently of the parameter "Staircase time retriggerable".
- ❗ When the supplementary function "Time extension" is preset, the parameter "Staircase time retriggerable" cannot be adjusted. In this case, it is permanently set to "no".

### Specifying switch-off behaviour of the staircase function

In the case of a staircase function, the reaction to an OFF telegram can also be configured on the object "Staircase function start/stop". Without the receipt of an OFF telegram the output switches off after the pre-warning time elapses, if necessary. Taking into account any possible switch-on delay and pre-warning function, this gives rise to the switch-off behaviour of the staircase function as shown in the following diagram.

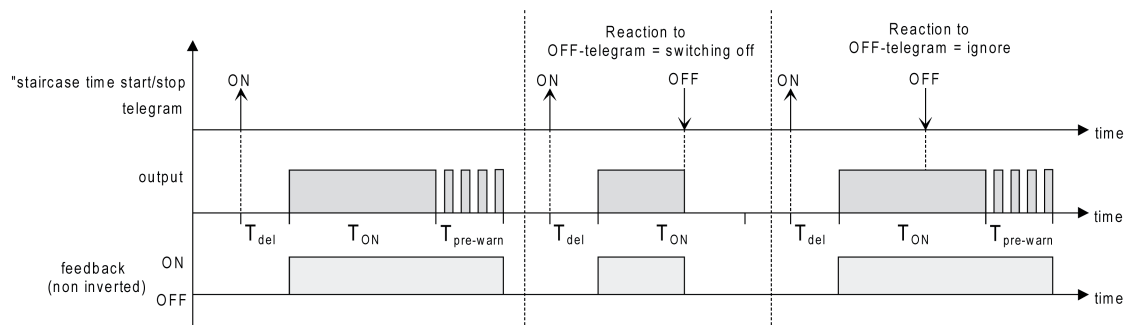

Figure 33: Switch-off behaviour of the staircase function

The parameter "reaction to OFF-telegram" defines whether the staircase time ( $T_{EIN}$ ) of the staircase function can be aborted prematurely.

Precondition:

The staircase function must have been enabled on parameter page "Ax – Enabled functions".

- Set parameter "Reaction to OFF-telegram" to "switch off".  
As soon as an OFF telegram is received via the object "Staircase function start/stop" during the ON phase of the staircase time, the output switches off immediately. If the staircase time is stopped prematurely by such a telegram, there is no pre-warning, i.e. the pre-warning time is not started.
- Set parameter "Reaction to OFF-telegram" to ignore".  
OFF telegrams received during the ON phase of the staircase time are rejected. The staircase time will be executed completely to the end with pre-warning if necessary.
- ❗ With the supplementary function "Time preset via the bus", the staircase time of the staircase function can also be started by the reception of a new time factor (cf. "Setting supplementary function of the staircase function – time preset via the bus"). In this case, received "0" factors are interpreted as an OFF telegram. Here too, the parameter "Reaction to OFF telegram" is evaluated so that a staircase time can be cancelled early.
- ❗ The parameter "Reaction to OFF telegram" does not influence the reception and the evaluation of OFF telegrams via the "Switching" object.

## Setting the switch-on delay of the staircase function

An ON telegram for activation of the staircase function can also be evaluated with a time delay. This switch-on delay can be activated separately for the staircase function and has no influence on the configurable time delays for the object "switching".

Precondition:

The staircase function must have been enabled on parameter page "Ax – Enabled functions".

- Set the parameter "Activate switch-on delay for the staircase function?" on parameter page "Ax – Staircase function" to "no".

The switch-on delay is deactivated. After reception of an ON telegram on the object "Staircase function start/stop", the staircase time is activated immediately and the output switched on.

- Set the parameter "Activate the switch-on delay for the staircase function?" to "yes".

The switch-on delay for the staircase function is enabled. The desired switch-on delay time can be specified. After reception of an ON telegram on the object "Staircase function start/stop", the switch-on delay is started. Another ON-telegram triggers the time only when the parameter "Switch-on delay retriggerable?" is set to "yes". The staircase time is activated and the output is switched on only after the time delay has elapsed.

- i** An OFF telegram via the object "Staircase function start/stop" during the switch-on delay only terminates the delay if the parameter "Reaction to OFF-telegram" is set to "switch off". Otherwise, the OFF telegram is ignored.
- i** When the supplementary function "Time extension" is preset, the parameter "Switch-on delay retriggerable?" cannot be changed. In this case, it is permanently set to "No".

## Setting the pre-warning function of the staircase function

The pre-warning should, according to DIN 18015-2, warn persons still on the staircase that the light will soon be switched off. The lighting connected on the output is briefly switched off repeatedly as a pre-warning, before the output is switched off permanently. At the same time, the pre-warning time ( $T_{\text{Vorwarn}}$ ), the duration of the interruptions during the pre-warning ( $T_{\text{Unterbr}}$ ) and the number of pre-warning interruptions are configurable (Figure 34). The pre-warning time is added to the staircase time ( $T_{\text{EIN}}$ ). The pre-warning time influences the value of the feedback object so that the value "OFF" (in the case of non-inverted transmission) is first tracked after the pre-warning time in the object has elapsed.

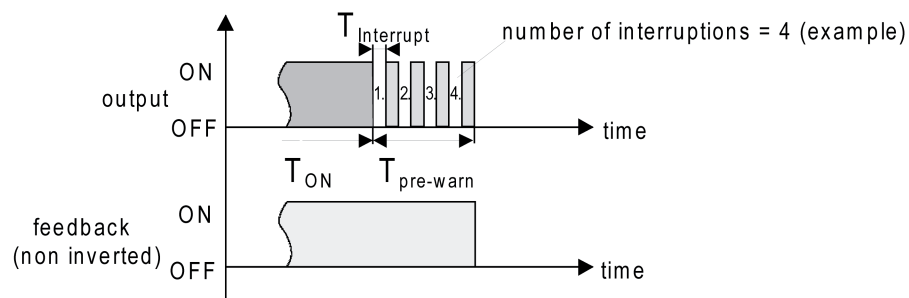

Figure 34: The pre-warning function of the staircase function (example)

Precondition:

The staircase function must have been enabled on parameter page "Ax – Enabled functions".

- Set the parameter "Reaction at the end of the staircase time" on the parameter page "Ax – Staircase function" to "Activate pre-warning time".

The pre-warning function is enabled. The desired pre-warning time ( $T_{\text{Vorwarn}}$ ) can be preset.

- Set the parameter "Number of pre-warnings" to the desired value (1...10).

Within the pre-warning time, the lighting connected on the output is switched off just as often as configured here. The 1st pre-warning is always executed at the beginning of the entire pre-warning time.

- Set the parameters "Time for pre-warning interruptions" to the desired value.

An interruption ( $T_{\text{Unterbr}}$ ) during the pre-warning time is just as long as configured here. The adjustable interruption time allows the switch-off phase of the lighting to be adapted individually to the lamps used.

- i** It should be noted that the "number of pre-warnings" and the "time for pre-warning interruptions" must be attuned to the duration of the entire "pre-warning time". Hence, the entire switch-off phase during a pre-warning ("number of pre-warnings" + "time for pre-warning interruptions") must not be set longer than the pre-warning time! Otherwise, malfunctions can be expected.
- i** An ON telegram to the object "Staircase function start/stop" while a pre-warning function is still in progress stops the pre-warning time and always restarts the staircase time (independently of the parameter "Staircase time retriggerable"). Even during the pre-warning time, the parameter "reaction to OFF telegram" is evaluated so that a pre-warning in progress can be terminated early by switching off.

### Setting supplementary function of the staircase function – time extension

With the time extension function, the staircase time can be retriggered several times (i.e. extended) via the "Staircase function start/stop" object. The duration of the extension is predefined by several operations at the control section (several ON telegrams in succession). The configured staircase time can be extended in this way by the configured factor (a maximum of 5-fold). The time is then always extended automatically at the end of a single staircase time ( $T_{\text{EIN}}$ ).

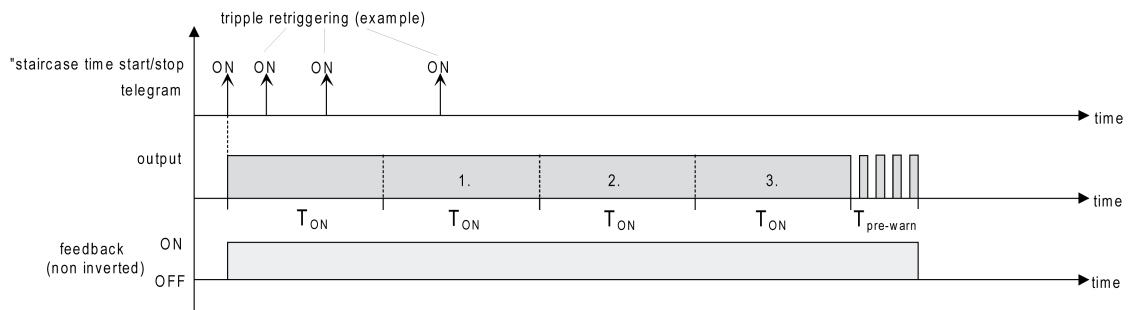

Figure 35: Time extension of the staircase function

With this function, the lighting time in a staircase can be extended (e.g. by a person after shopping) by a defined length without having to retrigger the lighting every time the lighting shuts off automatically.

Precondition:

The staircase function must have been enabled on parameter page "Ax – Enabled functions".

- Set the parameter "Supplementary function for staircase function" on the parameter page "Ax – Staircase function" to "time extension" and set the maximum desired factor on the parameter "maximum time extension".

The staircase time is retriggered each time an ON telegram is received on the "staircase time start/stop" object after the staircase time has elapsed, depending on the number of telegrams received, but only as often as pre-defined by the configured factor.

For example, the "3-fold time" setting means that after the started staircase time has elapsed, it can be retriggered automatically a maximum of three additional times. The time is therefore extended a maximum of four fold.

- i** A time extension can be triggered during the entire staircase time ( $T_{EIN}$ ). There is no time limit between two telegrams for the time extension. Telegrams for the time extension are only evaluated during the staircase time. An ON telegram during the pre-warning function triggers the staircase time as a restart, which means that a new time extension is possible. If a switch-on delay was configured, the time extension is recorded during the switch-on delay.
- i** If a time extension was configured as a supplementary function, the parameters "Staircase time retriggerable" and "Switch-on delay retriggerable ?" is preset to "No" because the retriggering takes place by the time extension.

### Setting supplementary function of the staircase function – time preset via the bus

With the time preset via the bus, the configured staircase time can be multiplied by an 8-bit factor received via the bus, thus it can be adapted dynamically. With this setting, the factor is derived from the object "staircase time factor". The possible factor value for setting the staircase time is between 1...255.

The entire staircase time arises as a product from factor (object value) and the configured staircase time as a basis as follows...

Staircase time = (staircase time object value) x (staircase time parameter)

#### Example:

Object value "staircase time factor" = 5; parameter "staircase value" = 10s.  
-> set staircase time = 5 x 10s = 50 s.

Alternatively, the staircase function parameter can define whether the receipt of a new factor also starts the staircase time of the staircase function at the same time. In this case, the object "Staircase function start/stop" is not necessary and the received factor value determines the starting and stopping.

#### Precondition:

The staircase function must have been enabled on parameter page "Ax – Enabled functions".

- Set "supplementary function for staircase function" on the parameter page "Ax – Staircase function" to "time preset via the bus" and set the parameter "staircase function activatable via 'staircase time' object ?" to "no".

The staircase time can be adapted dynamically by the "staircase time factor" object. A value "0" is interpreted as value "1". The staircase function is started and stopped exclusively via the "staircase function start / stop" object.

- Set "supplementary function for staircase function" to "time preset via the bus" and set the parameter "staircase function activatable via 'staircase time' object?" to "yes".

The staircase time can be adapted dynamically by the "staircase time factor" object. In addition, the staircase function is started with the new staircase time (the "staircase function start / stop" is not necessary) after receiving a new factor. A factor value "0" is interpreted as an OFF telegram, whereby in this case, the configured reaction to an OFF telegram is evaluated, too.

A larger staircase with several floors is an example as an application for the time preset via the bus with automatic starting of the staircase time. On each floor there is a push-button sensor that transmits a factor value to the staircase function. The higher the floor, the greater the factor value transmitted so that the lighting stays switched on longer if the passing through the staircase needs more time. When a person enters a staircase and a pushbutton is pressed, the staircase time is now adjusted dynamically to the staircase time and switches on the lighting at the same time, too.

- i** The staircase function is started via the reception of a new factor: A factor > 0 received during a pre-warning time always triggers the staircase time independently of the parameter "Staircase time retriggerable".

- i** After a reset (bus voltage return or ETS programming) the "staircase time factor" object is always initialised with "1". However, the staircase function is not started automatically solely as the result of this (see "Set behaviour of staircase function after bus voltage return").
- i** The two supplementary functions "time extension" and "time preset via the bus" can only be configured alternatively.

### **Setting the behaviour of the staircase function after bus voltage return**

The staircase function can optionally be started automatically after bus voltage return.

Precondition:

The staircase function must have been enabled on parameter page "Ax – Enabled functions."

- Set the parameter "Behaviour after bus voltage return" on the parameter page "Ax – General" to "Activate staircase function".

Immediately after bus voltage return, the staircase time of the staircase function is started.

- i** During automatic starting of the staircase function after bus voltage return, no switch-on delay is started if the staircase function has configured such a delay.
- i** The device only executes the configured "Behaviour on bus voltage return" only if the last ETS programming of the application or of the parameters ended at least approx. 20 s prior to switching on the bus voltage. Otherwise (TETS < 20 s), the "Behaviour after ETS programming" will be adopted also in case of bus voltage return.
- i** The configured behaviour will only be executed, if no forced position on bus voltage return is activated.



## 4.2.4.3.8 Scene function

### Functional description

Up to 10 scenes can be programmed and scene values stored separately in the actuator for each switching channel. The scene values are recalled or stored via a separate scene extension object. The data point type of the extension object permits addressing of a maximum of 64 scenes. This means that, in the configuration of a scene, it is possible to specify which scene number (1...64) contacts the internal scene (1...10).

The scene function must be enabled on parameter page "Ax - Enabling functions" for each switching channel in order for the required communication objects and parameters (on the parameter page "Ax - Scene function") to be visible.

The scene function can be combined together with other functions of a switching channel, whereby the last received or preset state is always executed:

Telegrams to the "Switching" objects, a scene recall or scene storage telegram at the time of an active staircase function aborts the staircase time prematurely and presets the brightness state according to the received object value (time delays are also taken into account) or scene value. Likewise, the brightness state of the switching channel, which was preset by the "switching", "dimming" or "brightness value" objects or by a scene recall, can be overridden by a staircase function.

### Presetting a scene recall delay for the scene function

Each scene recall of a switching channel can optionally also be delayed. With this feature, dynamic scene sequences can be configured if several scene output channels are combined with cyclical scene telegrams.

#### Precondition

The scene function must be enabled on parameter page "Ax - Enabled functions".

- Set the parameter "Delay scene recall?" on the "Ax - Scene function" parameter page to "yes".

The delay time is now activated and can be configured separately. The delay only influences the scene recall of the switching channel. The delay time is started on arrival of a recall telegram. The corresponding scene will be recalled and the switching channel set to the switching state value only after this time has elapsed.

- i** Each scene recall telegram restarts the delay time and retriggers it. If a new scene recall telegram is received while a delay is active (scene recall not yet executed), the old (and not yet recalled scene) will be rejected and only the scene last received executed.
- i** The scene recall delay has no influence on the storage of scene values. A scene storage telegram within a scene recall delay terminates the delay and thus the scene recall.

### Presetting the ETS download behaviour for the scene function

During storage of a scene, the scene values are stored internally to non-volatile memory in the device. To prevent the stored values from being replaced during ETS programming of the application or parameters by the originally programmed scene switching states, the actuator can inhibit overwriting of the scene values. As an alternative, the original values can be reloaded into the device during each programming run of the ETS.

#### Precondition

The scene function must be enabled on parameter page "Ax - Enabled functions".

- Set the parameter "Overwrite the values stored in the device during ETS download?" on the parameter page "Ax - Scene function" to "yes".

During each ETS programming operation of the application or of the parameters, the scene commands configured in the ETS for the switching channel concerned will be programmed into the actuator. Scene commands stored in the device by means of a storage function will be overwritten, if any.

- Set the parameter "Overwrite values stored in the device during ETS download?" to "no".

Scene commands stored in the device with a storage function will be maintained. If no scene commands have been stored, the switching states last programmed in the ETS remain valid.

- i** When the actuator is commissioned for the first time, this parameter should be set to "Yes" so that the switching channel is initialised with valid scene commands.

## Setting scene numbers and scene switching states for scene function

The datapoint type of the scene extension object permits addressing of up to 64 scenes max. For this reason, the scene number (1...64) with which the scene is addressed, i.e. recalled or stored, must be determined for each internal scene (1...10) of the switching channel. Moreover, the scene command (ON, OFF) to be set at the switching output in case of a scene recall must be specified.

### Precondition

The scene function must be enabled on parameter page "Ax - Enabled functions".

- Set the parameter "Scene x activatable by scene number" (x = number of the scene (1...10)) for each scene on parameter page "Ax – Scene function" to the numbers with which the scenes are to be addressed.

A scene can be addressed with the configured scene number. A setting of "0" deactivates the corresponding scene so that neither recalling nor storage is possible.

- i** If the same scene number is parameterized for several scenes, only the scene with the lowest internal scene number (1...10) will be addressed. The other internal scenes will be ignored in this case.

- Set the parameter "Switching state for scene x" (x = number of the scene (1...10)) on parameter page "Ax – Scene function" for each scene to the desired switching command.

During a scene recall, the configured switching state is recalled and set on the switching channel.

- i** The configured switching state is adopted in the actuator during programming with the ETS only if the parameter "Overwrite values stored in the device during ETS download?" is set to "yes".

## Presetting the storage behaviour for the scene function

The switching state set for the switching channel can be stored internally via the extension object on reception of a scene storage telegram. In this case, the switching state can be influenced before the storage by all functions of the switching channel provided the individual functions have been enabled (e.g. also the disabling function, forced-control position function etc.).

### Precondition

The scene function must be enabled on parameter page "Ax - Enabled functions".

- Set the parameter "Storage function for scene x" (x = number of the scene (1...10)) on parameter page "Ax – Scene function" for each scene to "Yes".

The storage function is activated for the scene in question. On reception of a storage telegram via the "Scene extension" object, the current switching state will be internally stored.

- Set the parameter "Storage function for scene x" (x = number of the scene (1...10)) to "No" for each scene.

The storage function is deactivated for the scene in question. A storage telegram received via the "scene extension" object will be rejected.

## Configure extended scene recall

The extended scene recall allows polling of the 10 scenes of a switching channel in sequence. Here, scene recall takes place via the 1-bit communication object "Extended scene recall". Each ON telegram received via this object recalls the next scene. Each OFF telegram received recalls the previous scene.

With the extended scene recall, the actuator always recalls the neighbouring scene - starting with the scene most recently recalled via the extended recall. It is irrelevant whether the scene is active on the appropriate switching channel (assigned scene number = "1...64") or inactive (assigned scene number = "0"). If an inactive scene is recalled via the extended scene recall, the appropriate switching channel will not react.

After a reset (bus voltage return, ETS programming operation), an ON or OFF telegram always recalls scene 1 first.

**i** Recall of a scene via the 1-byte extension object does not influence the scene sequence of the extended scene recall. The two recall functions work independently of each other.

- Set the parameter "Use extended scene recall?" on the parameter page "Ax - Scene function" to "Yes".

The object "Extended scene recall" is available. Each ON telegram recalls the next scene. Each OFF telegram recalls the previous scene.

- Set the parameter "Use extended scene recall?" to "no".

The extended scene recall is deactivated. A scene recall can only take place via the 1-byte scene extension object.

The extended scene recall can take place with or without an overflow at the scene limits. An overflow occurs when scene 10 is reached when counting up or scene 1 when counting down and an additional telegram in the last counting direction is received by the actuator. The overflow behaviour is defined in the ETS.

- Set the parameter "Use extended scene recall with overflow?" to "yes".

After reaching scene 10, a further ON telegram of the overflow is executed and scene 1 recalled. In the same way, after reaching scene 1, a further OFF telegram of the overflow is executed and scene 10 recalled.

- Set the parameter "Use extended scene recall with overflow?" to "no".

A scene overflow is not possible. After reaching scene 10, further ON telegrams of the extended scene recall are ignored. In the same way, the actuator ignores further OFF telegrams if scene 1 was recalled last.

#### 4.2.4.3.9 Supplementary function

##### Functional description

Supplementary functions can be enabled for each switching channel. As a supplementary function, a disabling or alternatively a forced position function can be configured. In this respect, only one of these functions can be enabled for one switching channel. Additionally, a logic operation function can be parameterized.

The supplementary functions are enabled and configured on parameter page "Ax – Supplementary functions".

##### Setting disabling function as supplementary function

During an active disabling function, the KNX control of the switching channel concerned is overridden and locked. Continuous light switching, for example, can also be overridden.

- On the parameter page "Ax - supplementary functions", set the parameter "type of supplementary function" to "disabling function".

The disabling function is enabled. The communication object "Disable" and the parameters of the disabling function become visible.

- On the parameter page "Ax - supplementary functions", set the parameter "polarity disabling object" to the desired polarity.
- Set the parameter "Behaviour at the beginning of the disabling function" to the required behaviour.

At the beginning of the disabling function, the configured behaviour will be executed and the bus control of the switching channel locked.

In the "No change of switching state" setting, the relay is switched to the most recently switching state defined by a bus operation. This ensures that relays altered by a manual operation are in the right switching state. If the relays are already in the correct position, then the actuator does not react.

In the "Flashing" setting, the switching channel is switched on and off cyclically during the disabling. The "Time for flashing" is generally configured on the parameter page "Times". During flashing, the logical switching state of the switching channel is fed back as "Switched on".

- Set the parameter "setting the behaviour at the end of the disabling function" to the required behaviour.

At the end of the disabling function, the configured behaviour will be executed and the bus operation of the switching channel enabled again.

In the "No change of switching state" setting, the relay is moved to the state set at the beginning of disabling. If, during the disabling function, the relays were not moved manually, the actuator will not show any switching reaction. Otherwise, the relay switches to the specified position.

In "Set tracked state", the last switching state received during the disabling function or the switching state set before the disabling function will be tracked. Any time functions still in progress will also be taken into account if necessary.

In the "Flashing" setting, the switching channel is switched on and off cyclically after disabling. The flashing time is generally configured on the parameter page "Times". During flashing, the logical switching state of the channel is fed back as "Switched on". The flashing state remains active until another bus command is received and thereby predefines another switching state.

- ❗ After a bus failure or after programming the application or the parameters with the ETS, the disabling function is always deactivated (object value "0"). With the inverted setting "1 = enabled; 0 = disabled", a telegram update "0" must first be carried out after the initialisation until the disabling is activated.

- i** Updates of the disabling object from "activated" to "deactivated" do not produce a reaction.
- i** The relay of a switching channel disabled via the KNX can still be operated manually.
- i** In the setting "Set tracked state": During a disabling function, the overridden functions of the actuator (switching, scenes) continue to be executed internally. Consequently, newly received bus telegrams are evaluated and time functions are triggered as well. At the end of the disabling, the tracked states are set.

## Setting forced position function as supplementary function

The forced position function can also be combined with other functions of a switching channel. With an active forced position, functions with a lower priority are overridden so that the switching channel concerned is locked.

The forced position function possesses a separate 2-bit communication object. The first bit (Bit 0) of the object "Forced position" indicates whether the switching channel is switched off or switched on by force. The second bit (bit 1) activates or deactivates the forced-position state (see table below).

The behaviour of a switching channel at the end of the forced-position function can be configured. In addition, the forced object can be initialised on bus voltage return.

Bit 1	Bit 0	Function
0	x	Forced position not active -> normal control
0	x	Forced position not active -> normal control
1	0	Forced position active: switch off
1	1	Forced position active: switch on

### Bit coding of forced position

- On the parameter page "Ax - supplementary functions", set the parameter "type of supplementary function" to "forced position".

The forced position function is enabled. The communication object "forced position" and the parameter of the forced position function become visible.
- Set the parameter "Behaviour at the end of the forced position 'inactive'" to the required behaviour.

At the end of the forced position, the configured behaviour will be executed and the bus control of the switching channel enabled again.

In the "No change of switching state" setting, the relay are moved to the state set at the beginning of forced operation. If, during the forced position, the relays were not moved manually, the actuator will not show any switching reaction. Otherwise, the relay switches to the specified position.

In the "Track switching state", the state received during the forced position function or the switching state set before the function can be tracked at the end of the forced position. Any time functions still in progress will also be taken into account if necessary.
- i** Updates of the forced position object from "Forced position active" to "Forced position active" while maintaining the switching status or from "Forced position inactive" to "Forced position inactive" show no reaction.
- i** A forcibly activated switching channel via the KNX can be still be operated manually!
- i** In the setting "Track switching state" at the end of the forced position: During a forced position, the overridden functions of the actuator (switching, scenes) continue to be executed internally. Consequently, newly received bus telegrams are evaluated and time functions are triggered as well. At the forced end, the tracked states are set.



The logic operation function is enabled. The communication object "logic operation" and the parameters of the logic operation function become visible.

- Set the parameter "Type of logic operation function" to the desired logic operation type.
- Set the parameters "object value of the logic operation object after bus voltage return" and "object value of the logic operation object after ETS download" to the required initial states.

The "logic operation" object is initialised immediately with the set switching states after bus voltage return or ETS programming of the application program or parameters.

- i** The logic operation function after a reset of the actuator (bus voltage return or ETS programming operation) is first executed when the switching object is updated as the input of the logic operation by at least one telegram.
- i** The states or switching states specified at the end of a disabling function or forced position function, which are set after programming in the ETS, in the case of bus voltage failure or after bus or mains voltage return, override the logic operation function. The configured logic operation is first re-executed and the result set on the output of the switching channel when the switching object is updated as the input of the logic operation by at least one telegram.

## 4.2.4.4 Operating hours counter

### Introduction

The operating hours counter determines the switch-on time of a relay. For the operating hours counter a relay output is actively on, when the relay contact is closed, i.e. when current is flowing to the load. In consequence, a closed contact is always evaluated, irrespective of the set relay operating mode for independent switching channels (NO or NC contact) and the logical feedback of the switching status.

When counting the operating hours, it is irrelevant whether the relay is activated by one or more dimming channels or by an independent switching channel. The operating hours counter adds up the determined switch-on time accurately to the minute for switched-on relays (contact closed) in full hours respectively (Figure 37). The totalled operating hours are added in a 2-byte meter and stored permanently in the device. The current meter reading can be transmitted cyclically to the bus by the "value operating hours counter" communication object or when there is a change in an interval value.

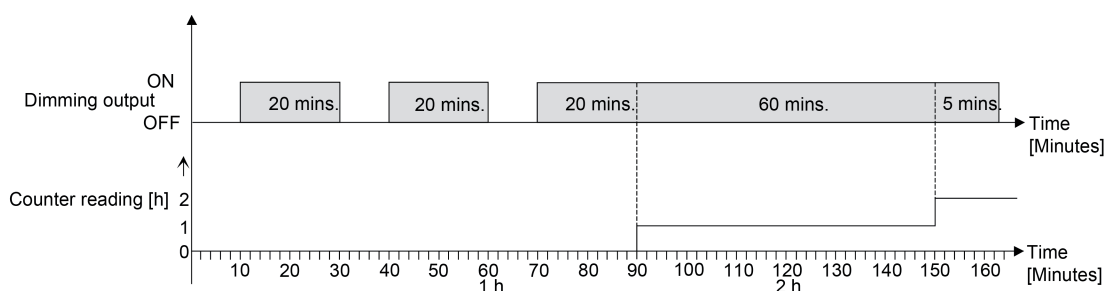

Figure 37: Function of the operating hours counter (using the example of an up-counter)

In the as-delivered state, all the operating hour values of the actuator are "0 h". If the operating hours counter is not enabled in the configuration, no operating hours will be counted for the appropriate relay. Once the operating hours counter is enabled, however, the operating hours will be determined and added up by the ETS immediately after commissioning the actuator. If the operating hours counter is subsequently disabled again in the parameters and the actuator is programmed with this disabling function, all operating hours previously counted for the appropriate relay will be deleted. When enabled again, the meter reading of the operating hours counter is always on "0 h".

The operating hours values (full hours) stored in the device will not be lost in case of a bus voltage failure or by ETS programming. Any summed up operating minutes (full hour not yet reached) will be rejected in this case, however.

After bus voltage return or after an ETS download, the actuator updates the communication objects "Value of operating hours counter" and "Operating hours count. elapsed" with the required values and states. The object values are then transmitted actively to the bus without a delay.

Manual operation of the relays using the sliding switch is not detected by the operating hours counters. In consequence, manual closing of a relay contact does not cause counting of operating hours and manual opening does not interrupt a count.

### Activating the operating hours counter

Depending on activation by dimming channels or independent switching channels, the operating hours counter of a relay is activated on different parameter pages.

- Operating hours counter in combination with dimming channels:  
Set the parameter "Operating hours counter" on parameter page "Ax - Operating hours counter" to "Enabled".



- Operating hours counter in combination with independent switching channels:  
Set the parameter "enabling functions" on parameter page "Ax - Operating hours counter" to "enabled".  
The operating hours counter is activated. Additional parameters become visible on the parameter page "Ax – Operating hours counter".

## Deactivating the operating hours counter

- Operating hours counter in combination with dimming channels:  
Set the parameter "Operating hours counter" on parameter page "Ax - Operating hours counter" to "Disabled".
  - Operating hours counter in combination with independent switching channels:  
Set the parameter "enabling functions" on parameter page "Ax - Operating hours counter" to "disabled".  
The operating hours counter is deactivated.
- i** Disabling of the operating hours counter and subsequent programming with the ETS resets the meter reading to "0 h".

## Setting type of counter of the operating hours counter

The operating hours counter can optionally be configured as an up-counter or down-counter. Depending on this type of counter, a limit or start value can be set optionally, whereby, for example, the operating time of a lamp can be monitored by restricting the counter range.

### Up-counter:

After activating the operating hours counter by enabling in the ETS or by restarting, the operating hours are counted starting at "0 h". A maximum of 65535 hours can be counted, after that the meter stops and signals a counter operation via the "Operating hours count. elapsed" object.

A limiting value can be set optionally in the ETS or can be predefined via the communication object "Limiting value operating hours counter". In this case, the counter operation is signalled to the bus via the "Operating hours count. elapsed" object if the limiting value is reached, but the meter continues counting - if it is not restarted - up to the maximum value 65535 and then stops. Only a restart initiates a new counting operation.

### Down-counter:

After enabling the operating hours counter in the ETS, the meter reading is on "0 h" and the actuator signals a counter operation for the dimming channel concerned after the programming operation or after bus voltage return via the "Operating hours count. elapsed" object. Only after a restart is the down-counter set to the maximum value 65535 the counting operation started. A start value can be set optionally in the ETS or can be predefined via the communication object "start value operating hours counter". If a start value is set, the down-counter is initialised with this value instead of the maximum value after a restart. The meter then counts the start value downwards by the hour. When the down-counter reaches the value "0 h", the counter operation is signalled to the bus via the "Operating hours count. elapsed" and the counting is stopped. Only a restart initiates a new counting operation.

### Precondition:

The operating hours counter must be activated in the ETS.

- Set the parameter "Type of counter" on parameter page "Ax - Operating hours counter" to "up-counter". Set the parameter "Limiting value specification?" to "yes, as parameter" or "yes, as received via object" if it is necessary to monitor the limiting value. Otherwise, reset the parameter to "no". In the "yes, as specified in parameter" setting, specify the required limit value (1...65535 h).

The meter counts the operating hours forwards starting from "0 h". If the monitoring of the limiting value is activated, the actuator transmits a "1" telegram via the object "Operating hours count. elapsed" once the predefined limiting value is reached. Otherwise, the counter operation is first transmitted when the maximum value 65535 is reached.

- Set the parameter "Type of counter" on parameter page "Ax - Operating hours counter" to "down-counter". Set the parameter "start value preset ?" to "yes, as parameter" or "yes, as received via object" if a start value preset is necessary. Otherwise, reset the parameter to "no". In the "yes, as specified in parameter" setting, specify the required start value (1...65535 h).

The meter counts the operating hours down to "0 h" after a restart. With a start value preset, the start value is counted down, otherwise the counting operation starts at the maximum value 65535. The actuator transmits a "1" telegram via the object "Operating hours count. elapsed" once the value "0" is reached.

- i** The value of the communication object "Operating hours count. elapsed" is stored permanently. The object is initialised immediately with the value that was saved before bus voltage return or ETS programming and actively transmitted to the bus without delay.
- i** With a limiting or start value preset via object: The values received via the object are first validly accepted and permanently saved internally after a restart of the operating hours counter. The object is initialised immediately with the value that was last saved before bus voltage return or ETS programming. The values received will be lost in the case of a bus voltage failure or by an ETS download if no counter restart was executed before. For this reason, when specifying a new start or limiting value it is advisable to always execute a counter restart afterwards as well.  
A standard value of 65535 is predefined provided that no limiting value or start value has been received yet via the object. The values received and stored via the object are reset to the standard value if the operating hours counter is disabled in the parameters of the ETS and a ETS download is being performed.
- i** If the counter direction of an operating hours counter is reversed by reconfiguration in the ETS, a restart of the meter should always be performed after programming the actuator so that the meter is reinitialised.

## Restarting the operating hours counter

The meter reading of the operating hours can be reset at any time by the communication object "Restart operating hours counter". The polarity of the restart telegram is predefined: "1" = Restart / "0" = No reaction.

- Characterise the communication object "restart operating hours counter" with "1".  
In the up-counter the meter is initialised with the value "0" after a restart and in the down-counter initialised with the start value. If no start value was configured or predefined by the object, the start value is preset to 65535.  
During every counter restart, the initialised meter reading is transmitted actively to the bus. After a restart, the signal of a counter operation is also reset. At the same time, a "0" telegram is transmitted to the bus via the object "Operating hours count. elapsed".  
In addition, the limiting or start value is initialised.
- i** If a new limiting or start value was predefined via the communication object, a counter restart should always be performed afterwards, too. Otherwise, the values received will be lost in the case of a bus voltage failure or by an ETS download.

## Transmission behaviour of the operating hours counter

The current value of the operating hours counter is always tracked in the communication object "value operating hours counter". After bus voltage return or after an ETS download, the actuator updates the "Value operating hours counter" communication object.  
In addition, the transmission behaviour of this communication object can be set.

**Precondition:**

The operating hours counter must be activated.

- Set the parameter "Automatic transmission of counting value" on parameter page "Ax - Operating hours counter" to "after change by interval value". Set the "Counting value interval (1...65535 h)" to the desired value.

The meter reading is transmitted to the bus as soon as it changes by the predefined counting value interval. After bus voltage return or after programming in the ETS, the object value is transmitted automatically after "Delay after bus voltage return" has elapsed if the current meter reading or a multiple of this corresponds to the counting value interval. A meter reading "0 h" is always transmitted in this case.

- Set the parameter "Automatic transmission of counting value" to "Cyclical".

The counter value is transmitted cyclically. The cycle time is defined independent of the channel on the parameter page "Times".

#### **4.2.4.5 Delivery state**

In the as-delivered state of the actuator, the application program is unloaded. All the relays are in the "OFF" switching state.

The sliding switches of the relays can be operated manually. There is no feedback to the KNX in this case.

The device can be programmed and put into operation via the ETS. The physical address is preset to 15.15.255

## 4.2.5 Parameters

### 4.2.5.1 General parameters

Description	Values	Comment
□ General		
Delay after bus voltage return Minutes (0...59)	<b>0</b> ...59	To reduce telegram traffic on the KNX line after bus voltage switch-on (bus reset), after connection of the device to the KNX line or after programming with the ETS, it is possible to delay various actively transmitting feedback telegrams of the actuator. For this purpose, a delay time can be defined here. Only after the configured time elapses are delayed feedback telegrams for initialisation transmitted to the bus.
		Setting the delay time minutes.
Seconds (0...59)	0... <b>17</b> ...59	Setting the delay time seconds.
Use central function 1?	yes <b>no</b>	The "Yes" setting enables the first central function and thus the "Central switching 1" object. An assignment of individual dimming or switching channels to the first central function is only possible if the function is enabled.
Central object polarity	<b>0 = deactivated;</b> <b>1 = activated</b>  0 = activated; 1 = deactivated	This parameter defines the polarity of the first central object. This parameter is visible only if central function 1 is enabled.
Use central function 2?	yes <b>no</b>	The "Yes" setting enables the second central function and thus the "Central switching 2" object. An assignment of individual dimming or switching channels to the second central function is only possible if the function is enabled.
Central object polarity	<b>0 = deactivated;</b> <b>1 = activated</b>  0 = activated; 1 = deactivated	This parameter defines the polarity of the second central object. This parameter is visible only if central function 2 is enabled.
Use central function 3?	yes <b>no</b>	The "Yes" setting enables the third central function and thus the "Central switching 3" object. An assignment of individual dimming or switching

		channels to the third central function is only possible if the function is enabled.
Central object polarity	<b>0 = deactivated;</b> <b>1 = activated</b>  0 = activated; 1 = deactivated	This parameter defines the polarity of the third central object. This parameter is visible only if central function 3 is enabled.
Collective feedback switching status?	<b>no</b>  <b>yes</b>	After central commands or after bus voltage return, a KNX line is generally heavily loaded by data traffic as many bus devices are actively transmitting the state of their communication objects by means of feedback telegrams. This effect occurs particularly when using visualisations. Collective feedback for switching states can be used to keep the telegram load low during initialisation. The collective feedback summarises the switching states of all the dimming channels and also of the independent switching channels in just one telegram. The 32-bit communication object "Collective feedback" contains bit-orientated feedback information of the individual channels. In the "yes" setting, this parameter enables collective feedback.
Collective feedback type	<b>active signalling object</b>  passive status object	Collective feedback can take place in the form of active message objects or passive status objects. In the case of active message objects, the feedback is automatically transmitted to the bus whenever the status contained therein is updated. In the function as a passive status object, there is no automatic telegram transmission. In this case, the object values must be read out. The ETS automatically sets the communication flags of the objects required for proper functioning. This parameter is visible only if collective feedback is enabled.
Time delay for feedback telegram after bus voltage return?	<b>no</b>  <b>yes</b>	If used as active message object, the collective feedback states are transmitted to the bus after bus voltage return or after an ETS programming operation. In these cases, the feedback can be time-delayed with the time delay being set globally on the "Times" parameter page This parameter is only visible in case of an actively transmitting feedback object.

Cyclical transmission of the feedback?	no	The objects of the collective feedback can also transmit their value cyclically in addition to transmission when updating. On "yes", cyclical transmission is performed. The cycle time is specified globally on parameter page "Times". In the "No" setting, cyclical transmission is deactivated, which means that collective feedback is only transmitted to the bus if one of the contained states changes.
	yes	This parameter is only visible in case of an actively transmitting feedback object.
Updating of the object value for collective feedback	after each update obj. "Switching" / "Central"	Here, you can specify when the Gateway should update the feedback values for the collective feedback in case of an actively transmitting communication object. The object value updated by the Gateway is then signalled actively to the bus. This parameter is only visible in case of an actively transmitting feedback object.
	<b>only if the feedback value changes</b>	The actuator updates the feedback value in the object once a new telegram is received on the input objects "Switching" or "Central switching" or the switching state changes internally (e.g. through a time function). A new telegram is also then actively transmitted to the bus each time. The telegram value of the feedback does not necessarily have to change in the process. Hence, corresponding collective feedback is also generated on a switching object such as in the case of cyclical telegrams, for example.
☐ Times	0...23	The transmitting feedback telegrams of the actuator can, depending on the
Time for cycl. transmission of		

feedbacks Hours (0...23)		parameterisation, also transmit their state cyclically to the bus. The parameter "Time for cyclical transmission of feedback tel." generally defines the cycle time for all channels.
		Setting the cycle time hours.
Minutes (0...59)	0... <b>2</b> ...59	Setting the cycle time minutes.
Seconds (10...59)	<b>10</b> ...59	Setting the cycle time seconds.
Time for cyclical monitoring Hours (0...23)	<b>0</b> ...23	Optionally, independent switching channels can be assigned to the cyclical monitoring, independently of each other. If, in so doing, no telegram update was received on the "Switching" object after the monitoring elapsed, the appropriate switching channel switches to a predefined preference position. The parameter "Time for cyclical monitoring" generally specifies the monitoring time for all the switching channels.
		Sets the monitoring time hours.
Minutes (0...59)	0... <b>2</b> ...59	Sets the monitoring time minutes.
Seconds (10...59)	<b>10</b> ...59	Sets the monitoring time seconds.
Time for cycl. transmission of operating hours Hours (0...23)	0... <b>23</b>	The operating hours counters - depending on the parameterisation - can also transmit their counter value cyclically to the bus. The parameter "Time for cyclical transmission of feedback tel." generally defines the cycle time for all operating hours counters.
		Setting the cycle time hours.
Minutes (0...59)	<b>0</b> ...59	Setting the cycle time minutes.
Seconds (10...59)	<b>10</b> ...59	Setting the cycle time seconds.
Time for flashing the disabling functions	<b>1 sec</b> 2 sec 5 sec 10 sec	At the start and end of the "Disable" supplementary function, a dimming or switching channel can flash. The flash cycle time is generally set here for all channels concerned.
□ Configuration of inputs / outputs		
Assignment of the dimming channels to the switching outputs		5 device configurations can be selected using this parameter, causing the assignment of the 4 individually-activatable dimming channels to the switching outputs. This means that, optionally, 1-10 V dimming channels can



4 separate switching/dimming channels	<p>be combined to execute a shared switching action, in order to implement different control tasks. Relay outputs not allocated to any dimming channel can be used as freely acting switching actuator channels.</p>
4 dimming channels with 1 switching channel + 3 switching channels	<p>In this configuration, the control unit is used classically. The 1-10 V inputs (E1...E4) are each assigned independently to the switching outputs (A1...A4). The feedback for the switching status and brightness values exist separately and can be evaluated.</p>
2 dimming channels with 1 switching channel + 2 switching/dimming channels + 1 switching channel	<p>This configuration is suitable, for example, for activating RGBW luminaires. Four 1-10 V inputs (E1...E4) are activated separately. An assigned switching output (A1) switches the load. Three further switching outputs (A2, A3, A4) can also be used independently. The four 1-10 V inputs can be activated separately, meaning that individual colour matching of the RGBW luminaire can be achieved.</p>
2 pairs of dimming channels each with 1 switching channel + 2 switching channels	<p>This setting provides two dimming channels (E1, E2), which jointly affect a switching output (A1). Two further 1-10 V inputs (E3, E4) each affect one switching output (A3, A4) and can be used independently. One switching output (A2) can be activated separately. Application of this configuration, e.g. in an open-plan office with 2 additional rooms.</p>
3 dimming channels with 1 switching channel + 1 switching/dimming channel + 2 switching channels	<p>Two dimming channels each (E1, E2 + E3, E4) affect one switching output (A1, A3) separately. Two switching outputs (A2, A4) can be activated separately. Application of this configuration, e.g. in a seminar room with 2 or 4-channel dimmer control in up to two load circuits.</p>
3 dimming channels with 1 switching channel + 1 switching/dimming channel + 2 switching channels	<p>This configuration is suitable, for example, for activating RGB luminaires and an additional dimmable lighting device. Three 1-10 V inputs (E1...E3) are activated separately. An assigned switching output (A1) switches the load. A further 1-10 V input (E4) affects another switching unit (A4). This switching/dimming channel can be used independently. In addition, two switching outputs (A2, A3) can be activated separately. The first three 1-10 V inputs can be activated separately, meaning that individual colour matching of the RGB luminaire can be achieved.</p>

## 4.2.5.2 Parameters of the dimming channels

Description	Values	Comment
<p>☐ Ex-General</p> <p>Name of the dimming channel</p>	20-character free text	<p>The text entered in this parameter is applied to the name of the parameter page and is used to label the dimming channel in the ETS parameter window (e.g. "Lighting, kitchen", "LED colour blue").</p> <p>The text is not programmed in the device.</p>
<p>Definition of the brightness range</p>	<p><b>with basic brightness</b></p> <p>with minimum brightness</p>	<p>The brightness range, adjustable by switching or dimming procedures, can be limited by defining a lower and upper brightness value. The lower brightness value is either defined by the basic brightness, or alternatively, by the minimum brightness. The upper brightness value is always characterised by the maximum brightness. The maximum brightness adjustable in the ETS is never exceeded under any circumstances in the switched-on operating state of a dimming channel. Neither when switching on nor when dimming.</p> <p>This parameter defines whether the adjustable brightness range at the lower limit will be limited by the basic brightness or by a minimum brightness.</p>
<p>Basic brightness</p>	<p>Level 1</p> <p><b>Level 2</b></p> <p>Level 3</p> <p>Level 4</p> <p>Level 5</p> <p>Level 6</p> <p>Level 7</p> <p>Level 8</p>	<p>The step value set here is a gauge for the minimum adjustable control voltage in relation to the decimal brightness values = "1", "2" and "3" (percentage: ~0.4 ... 1.2 %). The basic brightness can be undershot only by switching off. The configurable basic brightness enables the dimming signal to be adjusted in the smallest possible dimming position of the luminaire used. The basic brightness should be set to a step value at which the lamp at the smallest brightness value will still light up at an adequate level of brightness so that it is detected as switched on.</p> <p>This parameter is visible only if the "Definition of the brightness range" includes the "basic brightness".</p>
<p>Minimum brightness</p>	<p>1 %</p> <p>5 %</p> <p>10 %</p>	<p>The brightness set here is not undershot in any switched-on operating state. This parameter is visible only if the</p>

	15 % 20 % 25 % 30 % 35 % 40 % 45 %	"Definition of the brightness range" includes the "minimum brightness".
Maximum brightness	Basic brightness 5 % 10 % 15 % ... 95 % <b>100 %</b>	The brightness set here is not undershot in any switched-on operating state. The selection of the adjustable value is downwardly limited to 50 % when using a minimum brightness. Smaller values cannot be configured in this case because otherwise the adjustment range of the minimum brightness will be cut (minimum brightness < maximum brightness).
Behaviour after ETS programming		The actuator permits setting of the reaction separately for each dimming channel after an ETS programming operation.
	As response to bus voltage return	After an ETS programming operation, the dimming channel will behave in the manner defined in the parameter "Behaviour after bus voltage return". If the behaviour there is configured to "Brightness as before bus voltage failure", then that brightness value is also set after an ETS programming operation which was active at the time of the last bus voltage failure. An ETS programming operation does not overwrite the saved brightness value.
	Switch off	The dimming channel is switched off after a programming in the ETS. The assigned relay switches off if the switching status of another assigned dimming channel switches on the relay - depending on the configuration. The control voltage is set to approx. 0.8 V if the mains power supply is still switched on on connected consumers. Otherwise, the control value is undefined.
	<b>No reaction</b>	After an ETS programming operation, the control voltage remains the same and the relay is switched to the most recent switching state defined by bus operation. This ensures that relays altered by a manual operation are in the right switching state. If the relays are already in the correct position, then the actuator does not react.
	Brightness value	After an ETS programming operation, the dimming channel is set to the predefined brightness value. The



		during the bus failure, the relay was not moved manually, the actuator will not show any switching reaction. Otherwise, the relay switches to the specified position.
	Brightness value	After bus voltage return, the dimming channel is set to the predefined brightness value. The assigned relay switches on.
	Activating staircase function	The staircase function is – irrespective of the "Switching" object - activated after bus voltage return. This setting is only available when the staircase function is enabled.
Brightness value after bus voltage return	Basic brightness 5 % 10 % 15 % ... 95 % <b>100 %</b>	This parameter defines the brightness to be set after a bus voltage return. The parameter is only visible on "Behaviour after bus voltage return = Brightness value".
Switch-on brightness	Basic brightness 5 % 10 % 15 % ... 95 % <b>100 %</b> Memory value (brightness after last switch-off)	This parameter specifies the brightness value which should be set whenever switching on via the "Switching" or "Central switching" object on the dimming channel. The switch-on brightness must always be between the upper and lower brightness limit value of the dimming range. In the "Memory value" setting, the active and internally saved brightness value prior to switching off last time is set when switching on (via the "switching" or "central switching" object). The selection of "basic brightness" is not necessary when using a minimum brightness.
Dimming behaviour after receipt of a brightness value	<b>jumping to</b> dimming to fading	A parameter is used here to define whether a brightness value received via the bus is instantly jumped to (absolute dimming), or whether the brightness is dimmed to via the set dimming characteristic. Fading is also possible as an alternative. When fading, the received brightness value is reached in the exact configured fading time irrespective of the dimming characteristic and irrespective of which brightness value the dimming procedure was started at. Thus, for example, several dimming outputs can be set to

		the same brightness at the same time.
Time for brightness value via fading Seconds (0...240)	0... <b>20</b> ...240	The fading time is set here if fading is predefined in the dimming behaviour. A dimming procedure via fading lasts for the exact configured time. If "0 seconds" is set, the brightness value is jumped to directly.
Behaviour by relative dimming when OFF	<p><b>Dimming up switches channel ON (Standard)</b></p> <p>Dimming up is ignored (channel remains OFF)</p>	<p>This parameter defines whether or not a dimming channel in the "OFF" state reacts to a relative dimming telegram.</p> <p>The dimming channel always reacts to a relative dimming telegram and executes a dimming process. In the "OFF" state, the channel switches on with a "dim up" telegram.</p> <p>The dimming channel only reacts to a relative dimming telegram when it is switched on. In the "OFF" state, the channel ignores a "dim up" telegram.</p>
Assignment to central function 1?	yes <b>no</b>	<p>This parameter determines the assignment of the dimming channel to the first central function.</p> <p>This parameter is visible only if the first central function is enabled (parameter page "General").</p>
Assignment to central function 2?	yes <b>no</b>	<p>This parameter determines the assignment of the dimming channel to the second central function.</p> <p>This parameter is visible only if the second central function is enabled (parameter page "General").</p>
Assignment to central function 3?	yes <b>no</b>	<p>This parameter determines the assignment of the dimming channel to the third central function.</p> <p>This parameter is visible only if the third central function is enabled (parameter page "General").</p>
<input type="checkbox"/> Ex-Enabled functions		
Feedback telegrams	<b>Disabled</b> enabled	<p>This parameter can be used to disable or to enable the feedback functions. When the function is enabled, the required parameters will be displayed under "Ex –Feedbacks".</p>
Time delays		<p>This parameter can be used to disable or to enable the time delays. When the</p>

	<b>Disabled</b> enabled	function is enabled, the required parameters will be displayed under "Ex - Time delays".
Staircase function	<b>Disabled</b> enabled	This parameter can be used to disable or to enable the staircase function. When the function is enabled, the corresponding parameters will be displayed under "Ex Staircase function" and the necessary object enabled.
Switch-on/switch-off behaviour	<b>Disabled</b> enabled	The functions that influence the switch-on and switch-off behaviour of the dimming channel can be disabled or enabled here. When the functions are enabled, the required parameters will be displayed under "Ex - Switch-on/switch-off behaviour".
Scene function	<b>Disabled</b> enabled	This parameter can be used to disable or to enable the scene function. When the function is enabled, the corresponding parameters are displayed under "Ex - Scene function" and the necessary object enabled.
Burn-in function	<b>Disabled</b> enabled	This parameter can be used to disable or to enable the burn-in function. When the function is enabled, the required parameters are displayed under "Ex - Burn-in function".
<p>☐ Ex-Feedback telegrams</p> <p>Feedback switching status?</p>		
	<b>No feedback</b>	The current switching state of the dimming channel can be signalled back separately to the bus. All the switching status feedback of the affected dimming channel is deactivated.
	feedback object is active signalling object	The objects "Switching feedback" and "Switching feedback, shared relay status" are enabled. A switching status is transmitted as soon as it is updated. An automatic telegram transmission of the feedback takes place after bus voltage return or after programming with the ETS.
	feedback object is passive status object	The objects "Switching feedback" and "Switching feedback, shared relay status" are enabled. A switching status will be transmitted in response only if the feedback object is read out from by the

Updating the object value for switching status feedback

bus. No automatic telegram transmission of the feedback takes place after bus voltage return or after programming with the ETS.

Here, you can specify when the actuator should update the feedback value for the switching status (object "Switching feedback") in case of an actively transmitting communication object. The object value updated by the actuator is then signalled actively to the bus. This parameter is only visible in case of an actively transmitting feedback.

after each update obj.  
"Switching"/"Central"

The actuator updates the feedback value in the object once a new telegram is received on the input objects "Switching" or "Central switching" or the switching state changes internally (e.g. through a time function). With an actively transmitting feedback object, a new telegram is also then actively transmitted to the bus each time. The telegram value of the feedback does not necessarily have to change in the process. Hence, a corresponding switching status feedback is also generated on the "Switching" object such as in the case of cyclical telegrams for example.

**only if the feedback value changes**

The actuator only updates the feedback value in the object if the telegram value (e.g. "OFF" to "ON") also changes or the switching state changes internally (e.g. through a time function). If the telegram value of the feedback does not change (e.g. in the case of cyclical telegrams to the "Switching" object with the same telegram value), the actuator does not transmit any feedback. Consequently, with an actively transmitting feedback object, no telegram with the same content will be transmitted repeatedly either.

Time delay for feedback telegram after bus voltage return ? **yes**  
no

The states of the switching status feedback can be transmitted to the bus with a delay after bus voltage return or after programming with the ETS. The "Yes" setting activates the delay time in case of bus voltage return. The delay time is configured on the parameter page "Times".

This parameter is only visible in case of an actively transmitting feedback.



Cyclical transmission of the feedback?	<p>yes</p> <p>no</p>	<p>The switching status feedback telegrams can, if actively transmitting, also be transmitted cyclically, in addition to the transmission after updating. This parameter is only visible in case of an actively transmitting feedback.</p> <p>Cyclical transmission is activated.</p> <p>Cyclical transmission is deactivated so that the feedback is transmitted to the bus only when updated by the actuator.</p>
Feedback brightness value?	<p><b>No feedback</b></p> <p>feedback object is active signalling object</p> <p>feedback object is passive status object</p>	<p>The current brightness value of the dimming channel can be signalled back separately to the bus.</p> <p>No feedback object is available for the brightness value. Brightness value feedback deactivated.</p> <p>The "brightness value feedback" object is enabled. The brightness value is transmitted once this is updated. An automatic telegram transmission of the feedback takes place after bus voltage return or after programming with the ETS.</p> <p>The "brightness value feedback" object is enabled. The brightness value will be transmitted in response only if the feedback object is read out from by the bus. No automatic telegram transmission of the feedback takes place after bus voltage return or after programming with the ETS.</p>
Updating the object value for brightness value feedback	<p>after each update obj. "Brightness value"</p>	<p>You can specify here when the actuator should update the feedback value for the brightness value or speed in case of an actively transmitting communication object. The object value updated by the actuator is then signalled actively to the bus.</p> <p>This parameter is only visible in case of an actively transmitting feedback.</p> <p>The actuator updates the feedback value in the object once a new telegram is received on the input objects "Switching", "Central switching" or "Brightness value" or the brightness value changes internally (e.g. through a time function). With an actively transmitting feedback object, a new telegram is also then actively transmitted to the bus each time. The telegram value of the feedback does not necessarily have to change in the process. Hence, a corresponding brightness value feedback is also</p>

		generated on the "brightness value feedback" object such as in the case of cyclical telegrams for example.
	<b>only if the feedback value changes</b>	The actuator only updates the feedback value in the object if the telegram value (e.g. "0 %" to "100 %") also changes or the brightness value changes internally (e.g. through a time function). If the telegram value of the feedback does not change (e.g. in the case of cyclical telegrams to the "Brightness value" object with the same telegram value), the actuator does not transmit any feedback. Consequently, with an actively transmitting feedback object, no telegram with the same content will be transmitted repeatedly either.
Time delay for feedback telegram after bus voltage return ?	<b>yes</b> <b>no</b>	The brightness value feedback will be transmitted with a delay after bus voltage return or after programming with the ETS. No feedback telegram is transmitted during a running delay, even if the brightness value changes during this delay. This parameter is only visible in case of an actively transmitting feedback.
Cyclical transmission of the feedback ?	<b>yes</b> <b>no</b>	The brightness value feedback telegram can also be transmitted cyclically, if actively transmitting, in addition to transmission on updating. This parameter is only visible in case of an actively transmitting feedback. Cyclical transmission is activated. Cyclical transmission is deactivated so that the feedback telegram is transmitted to the bus only when updated by the actuator.
<input type="checkbox"/> Ex-Time delays		
Selection of time delay	<b>no time delay</b> Switch-on delay Switch-off delay ON delay and OFF delay	The "switching" communication object can be evaluated with a time delay. By this setting the desired function of the time delay is selected and the additional parameters of the delay enabled.
Switch-on delay Minutes (0...59)	<b>0...59</b>	This parameter is used for setting the duration of the switch-on delay.  Sets the switch-on delay minutes.

Seconds (0...59)	0... <b>10</b> ...59	Sets the switch-on delay seconds.
Switch-on delay retriggerable?	yes <b>no</b>	A switch-on delay still in progress can be retriggered (setting "yes") by another "ON" telegram. Alternatively, the retriggering time can be suppressed (setting "no").  The parameters for the switch-on delay are only visible if switch-on delay or switch-on and switch-off delay are activated.
Switch-off delay Minutes (0...59)	<b>0</b> ...59	This parameter is used for setting the duration of the switch-off delay.  Sets the switch-off delay minutes.
Seconds (0...59)	0... <b>10</b> ...59	Sets the switch-off delay seconds.
Switch-off delay retriggerable?	yes <b>no</b>	A switch-off delay still in progress can be retriggered (setting "yes") by another "OFF" telegram. Alternatively, the retriggering time can be suppressed (setting "no").  The parameters for the switch-off delay are only visible if switch-on delay or switch-on and switch-off delay are activated.
☐ Ex-Staircase function		
Staircase time Hours (0...23)	<b>0</b> ...23	This parameter is used for programming the duration of the switch-on time for a scene recall.  Switch-on time hours setting.
Minutes (0...59)	0... <b>3</b> ...59	Switch-on time minutes setting.
Seconds (0...59)	<b>0</b> ...59	Switch-on time seconds setting.
Staircase time retriggerable	<b>yes</b>  no	An active switch-on time can be retriggered (setting "yes"). Alternatively, the retriggering time can be suppressed (setting "no"). This parameter is preset to "no" if the supplementary function "Time extension" is configured. Re-triggering will not be possible.
Reaction to OFF-telegram		An active switch-on time can be aborted prematurely by switching off the staircase function.

	<b>switch off</b>	The switch-on time is aborted after receipt of an OFF telegram on the object "Staircase time start/stop". With the supplementary function "Time preset via the bus" and the setting "Staircase function activatable via object 'Staircase time' ? = yes", the switch-on time can also be prematurely ended by a factor of "0".
	ignore	OFF Telegrams or "0" factors are ignored. The switch-on time will be executed completely to the end.
Supplementary function for staircase function		The staircase function can be extended by the two supplementary functions "Time extension" and "Time specifications via bus", which should be used alternatively. This parameter enables the desired supplementary function and thereby activates the necessary parameters or objects.
	<b>No supplementary function</b>	No supplementary function is enabled.
	time extension	The time extension is activated. This function permits retriggering an activated staircase lighting time span-times via the object "Staircase function start/stop".
	Time preset via the bus	The time preset via the bus is activated. With this supplementary function, the configured switch-on time can be multiplied by a factor received via the KNX, thus it can be adapted dynamically.
Maximum time extension	<b>1-fold time</b> 2-fold time 3-fold time 4-fold time 5-fold time	In case of a time extension (retriggering the lighting time n-times via the object "Staircase function start/stop), the parameterized staircase lighting time will be extended by the value programmed in this parameter. "1-fold time" means that after the started staircase time has elapsed, it can be retriggered a maximum of one more time. The time is therefore extended two fold. The other settings behave in a similar manner. This parameter is visible only if the supplementary function "time extension" is set.
Staircase function activatable via "Staircase time" object?	yes <b>no</b>	A time preset via the bus can specify here whether the receipt of a new time factor also starts the switch-on time

<p>Reaction at the end of the staircase time</p>	<p><b>switch off</b></p>	<p>(setting "yes"). At the same time, the object "Staircase function start/stop" is hidden.          If the setting is "no", the switch-on time can be activated exclusively via the object "Staircase function start/stop". This parameter is visible only if the supplementary function "Time preset via the bus" is set.</p>
	<p>Activate pre-warning time</p>	<p>At the end of the switch-on time, the actuator for the dimming channel concerned displays the configured behaviour here. The channel can be set to switch off immediately, alternatively execute the pre-warning function or dim to reduced continuous lighting (application: e.g. long, dark hallways).</p> <p>At the end of the switch-on time, the actuator switches off the dimming channel concerned. If the soft OFF function is configured, switching off takes place via a dimming procedure.</p> <p>At the end of the switch-on time, the dimming channel can generate a pre-warning (reduction of brightness) prior to switching off. The pre-warning, for example, should warn any person still on the staircase that the light will soon be switched off.</p>
	<p>Activate reduced continuous lighting</p>	<p>At the end of the switch-on time, the actuator activates reduced continuous lighting for the dimming channel concerned. The reduction of the lighting to continuous lighting is appropriate, for example, if a certain degree of artificial light should be switched on permanently in long, dark hallways. Switching to switch-on brightness by activating the staircase function normally takes place by additional presence detectors or motion detectors when people are present in the hallway.          The continuous lighting remains permanently active after the switch-on time has elapsed. Only when an ON telegram is received again via the object "Staircase function start/stop" does the actuator switch back to the switch-on brightness and start counting the switch-on time again.</p>
<p>Pre-warning time          Minutes (0...59)</p>	<p><b>0...59</b></p>	<p>This parameter is used for setting the duration of the pre-warning time. The pre-warning time is added to the switch-on time. The reduced brightness is set during the time configured here.</p>

Seconds (0...59)	0... <b>30</b> ...59	Sets the pre-warning time in minutes. Sets the pre-warning time in seconds. These parameters are visible only if the pre-warning function is enabled.
Reduced brightness during the pre-warning time (1...100 %)	Basic brightness 5 % 10 % 15 % ... <b>50 %</b> ... 95 % 100 %	This parameter defines the reduced brightness that is set for pre-warning. This parameter is visible only if the pre-warning function is enabled.
Reduced brightness for continuous lighting (1...100 %)	Basic brightness 5 % 10 % 15 % ... <b>50 %</b> ... 95 % 100 %	This parameter defines the reduced brightness that is set for continuous lighting. This parameter is visible only if the continuous function is enabled.
<input type="checkbox"/> Ex-Switch-on/switch-off behaviour		
Soft ON function?	yes <b>no</b>	The soft ON function permits the dimming channel to be switched on more slowly. If this function (setting "yes") is activated, a dimming procedure to the switch-on brightness is executed after receiving a switch-on telegram via the "switching" or "central switching" object.
Time for soft ON dimming increment Seconds (0...59)	<b>0</b> ...59	These parameters set the soft ON function for the dimming increment time.  Setting of the seconds of the dimming increment time for soft ON.
Milliseconds (1...99 * 10)	<b>1</b> ...99	Milliseconds setting of the dimming increment time for soft ON.  The parameters for the soft ON function are visible only if the soft ON function is enabled.
Soft OFF function?	yes <b>no</b>	The soft OFF function permits the dimming channel to be switched off more slowly. If this function (setting "yes") is activated, a dimming procedure to the brightness "0 %" is executed after

		receiving a switch-off telegram via the "switching" or "central switching" object.
Time for soft OFF dimming increment Seconds (0...59)	<b>0...59</b>	These parameters set the soft OFF function for the dimming increment time.
Milliseconds (1...99 * 10)	<b>1...99</b>	Seconds setting of the dimming increment time for soft OFF.  Milliseconds setting of the dimming increment time for soft OFF.  The parameters for the soft OFF function are visible only if the soft OFF function is enabled.
Automatic switch-off when undershooting a brightness?	yes <b>no</b>	The automatic switch-off function of the dimming channel can be activated here. If this function is activated, the connect load will switch off completely when a configurable brightness is undershot at the end of a dimming procedure, and if necessary, after a delay time has elapsed.
Switch-off if brightness value smaller than	<b>5 %</b> 10 % 15 % ... 95 % 100 %	This parameter defines the brightness, which, if undershot, will cause the dimming channel to be switched off at the end of a dimming procedure, or if necessary, after a delay time has elapsed. This parameter is only visible if the switch-off function is activated.
Delay time until switching off?	yes <b>no</b>	Automatic switch-off of the switch-off function can optionally be delayed. This parameter activates the delay as required.
Delay time until switching off Hours (0...23)	<b>0...23</b>	This parameter sets the delay time of the switch-off function. If the switch-off brightness is undershot at the end of a dimming procedure, the dimming channel is switched off after the time set here has elapsed.
Minutes (0...59)	<b>0...59</b>	Setting the delay time hours.
Seconds (0...59)	<b>0...30...59</b>	Setting the delay time minutes. Setting the delay time seconds.
		The parameters for the time delay are visible only if the delay time is enabled.

☐ Ex-Scene function

<p>Delay scene recall?</p>	<p>yes no</p>	<p>A scene is recalled via the scene extension object. If needed, the scene recall on the actuator can be made with a delay after reception of a recall telegram (setting: "yes"). Alternatively, recall takes place immediately on reception of the telegram (setting: "no").</p>
<p>Delay time Minutes (0...59)</p>	<p>0...59</p>	<p>This parameter is used for setting the duration of the scene delay time.</p>
<p>Seconds (0...59)</p>	<p>0...10...59</p>	<p>Sets the scene delay time in minutes. Sets the scene delay time in seconds.</p>
		<p><b>i</b> The delay time parameters are only visible, if the parameter "Delay scene recall ?" is configured to "yes".</p>
<p>Behaviour when recalling a scene</p>	<p>Jumping to brightness value</p> <p><b>Dimming to brightness value via dimming increm. time</b></p> <p>Dimming brightness value via fading</p>	<p>When recalling a scene, the configured or stored scene value is set for the dimming channel concerned. This parameter setting can define whether the brightness value can be instantly jumped to or dimmed to or is set via fading. When fading, the brightness value to be set is reached in the exact configured fading time irrespective of the dimming characteristic of a channel and irrespective of which brightness value the dimming procedure was started at. Thus, for example, several dimming channels can be set to the same brightness at the same time.</p>
<p>Dimming increment time Milliseconds (0...255)</p>	<p>0...5...255</p>	<p>Setting of the dimming increment time if the brightness value of a scene should be dimmed.</p> <p>This parameter is visible only if the parameter "Behaviour when recalling a scene" is set to "Dim to brightness value via dimming increment time".</p>
<p>Fading time Seconds (0...240)</p>	<p>0...2...240</p>	<p>Setting of the fading time if the brightness value of a scene should be dimmed to via fading.</p> <p>This parameter is visible only if the parameter "behaviour when recalling a scene" is set to "dim to brightness value</p>



		via fading".
Overwrite values stored in the device during ETS download?	<p><b>yes</b></p> <p><b>no</b></p>	<p>During storage of a scene, the scene values (current states of the dimming channels concerned) are stored internally in the device. To prevent the stored values from being replaced during an ETS programming operation by the originally programmed scene values, the actuator can inhibit overwriting of the scene values (setting: "no"). As an alternative, the original values can be reloaded into the device during each ETS programming operation (setting: "yes").</p>
Use extended scene recall?	<p><b>yes</b></p> <p><b>no</b></p>	<p>The extended scene recall allows polling of the 10 scenes of the dimming channel in sequence. Here, scene recall takes place via the 1-bit communication object "Extended scene recall". Each ON telegram received via this object recalls the next scene. Each OFF telegram received recalls the previous scene. This parameter enables extended scene recall, if required.</p>
Scene X activatable by scene number (scene number "0" = scene deactivated)	<p>0...1*...64</p> <p>*: The predefined scene number is dependent on the scene (1...10).</p>	<p>The actuator distinguishes between up to 10 different scenes which are recalled via the scene extension object or stored. The datapoint type of the extension object, however, permits addressing a maximum of 64 scenes. This parameter defines the scene number (1...64) which is used to address the internal scene (1...10). A setting of "0" deactivates the corresponding scene.</p>
X = depending on the scene (1...10)		
Brightness value for scene x	<p>switch off</p> <p>Basic brightness</p> <p>5 %</p> <p>10 %</p> <p>15 %</p> <p>...</p> <p>95 %</p> <p>100 %</p>	<p>This parameter is used for configuring the brightness value which is set when the scene is recalled. The preset value depends on the scene.</p>
X = depending on the scene (1...10)		



Pause burn-in function via object?	<p>After a successful ETS programming operation, the burn-in function is immediately active with the configured burn-in period. Each ETS programming operation restarts the burn-in function with the remaining residual time. A fully elapsed burn-in period is restarted by a new ETS programming operation. After a bus voltage return, a burn-in function active at the time of a bus voltage failure is continued with the remaining burn-in period.</p>
yes	<p>It is possible to pause an active burn-in period as required. The pause is triggered and terminated by a separate 1-bit object.</p> <p>An "ON" telegram to the "Pause burn-in function" object interrupts an active burn-in function. The brightness value tracked for the dimming channel is set. The residual burn-in period remains intact. An "OFF" telegram lifts the pause and continues the execution of the burn-in function with the remaining residual time.</p>
no	<p>The pause function is not available.</p>
Feedback of the current burn-in period	<p>Optionally, a separate 1-byte object can be used to feed back the remaining residual time up to the end of the burn-in function or, alternatively, the burn-in time that has elapsed since the start, to the bus.</p>
<b>No feedback</b>	<p>The feedback function of the burn-in period is deactivated. The "Burn-in function duration" object is invisible.</p>
Remaining time	<p>The "Burn-in function duration" object becomes visible. It feeds back the remaining residual time of a burn-in phase in the data format "Hours". If the burn-in function is stopped, the object contains the value of the full burn-in period. With a paused function, the object contains the saved value of the residual time of the current burn-in phase.</p>
Elapsed time	<p>The "Burn-in function duration" object becomes visible. It feeds back the elapsed time of a burn-in phase in the data format "Hours". If the burn-in function is stopped, the object contains the value "0 h". With a paused function, the object contains the saved value of</p>

		the elapsed time of the current burn-in phase.
Type of feedback		The object "Burn-in function period" can work as an active signalling object, or alternatively, as a passive status object. This parameter is only visible if the feedback function is enabled.
	active signalling object	The length of the burn-in function (remaining or elapsed time) is transmitted as soon as the object value is updated by the actuator. Automatic telegram transmission of the feedback takes place after bus voltage return or after an ETS programming operation (if a delay after bus voltage return is configured, only after the delay time has elapsed).
	passive status object	The length of the burn-in function is only transmitted as a response when the "Burn-in function duration" object is read out by the bus. No automatic telegram transmission takes place after bus voltage return or after an ETS programming operation.
Cycle time of feedback Minutes (0...255) (0 = no cyclical transmission)	0...255	The object "Burn-in function duration" is updated when the feedback value changes. In addition, the object value can be transmitted cyclically, if the object is configured as actively transmitting. This parameter defines the cycle time for the cyclical transmission. In the "0 minutes" setting, cyclical transmission is deactivated. The feedback object only then transmits a telegram if there is a change. This parameter is only visible if the feedback function is enabled.
<input type="checkbox"/> Ex-Supplementary function		
Selection of supplementary function	<b>No supplementary function</b>  Disabling function  Forced position	The supplementary function can be defined and enabled here. The disabling function is only configurable as an alternative to the forced position function.
Polarity of the disabling object	<b>0 = disabled;</b> <b>1 = enabled</b>	This parameter defines the polarity of the disabling object.

	1 = enabled; 0 = disabled	This parameter is visible only if the disabling function is enabled.
Behaviour at the beginning of the disabling function		The behaviour of the dimming channel at the beginning of the disabling function can be configured. This parameter is visible only if the disabling function is enabled.
	<b>Switch off</b>	At the beginning of the disabling function, the dimming channel is switched off and locked.
	Flashing	The dimming channel is switched on and off cyclically during the disabling. The "Time for flashing" is generally configured on the parameter page "Times". During flashing, the logical switching state of the dimming channel is signalled back as "switched on" and the brightness value as "switch-on brightness". A soft ON/OFF function is not executed during flashing.
	Brightness value	The dimming channel is set to the predefined brightness value. The assigned relay switches on.
	No reaction	The control voltage remains the same and the relay is switched to the most recently switching state defined by bus operation. This ensures that relays altered by a manual operation are in the right switching state. If the relays are already in the correct position, then the actuator does not react.
	Memory value (brightness bef. switch. off last time)	The active and internally stored brightness value prior to the last switch-off is set (via the "Switching" or "Central switching" object). After programming with the ETS, the value is predefined to maximum brightness. Only a bus voltage failure does not delete the memory value.
Brightness value at the beginning of the disabling function	Basic brightness 5 % 10 % 15 % ... 95 % <b>100 %</b>	This parameter defines the brightness to be set at the beginning of the disabling function. The parameter is only visible on "Behaviour at beginning of disabling function = Brightness value".
Behaviour at the end of the disabling function		The behaviour of the dimming channel at the end of the disabling function can be configured. This parameter is visible only if the disabling function is enabled.

Switch off		At the end of the disabling function, the dimming channel is switched off and enabled again.
Flashing		The dimming channel is switched on and off cyclically after disabling. The flashing time is generally configured on the parameter page "Times". During flashing, the logical switching state of the channel is fed back as "switched on" and the brightness value as "switch-on brightness". A soft ON/OFF function is not executed during flashing. The flashing status remains active until another bus command is received and thereby predefines another brightness status.
Brightness value		The dimming channel is set to the predefined brightness value. The assigned relay switches on.
No reaction		The brightness value and relay are moved to the state set at the beginning of disabling. If, during the disabling function, the relays were not moved manually, the actuator will not show any switching reaction. Otherwise, the relay switches to the specified position.
Memory value (brightness bef. switch. off last time)		The active and internally stored brightness value prior to the last switch-off is set (via the "Switching" or "Central switching" object). After programming with the ETS, the value is predefined to maximum brightness. Only a bus voltage failure does not delete the memory value.
<b>tracked brightness value</b>		The set state received during the disabling function or adjusted before the disabling function can be tracked at the end of the disabling with the appropriate brightness value. Any time functions still in progress will also be taken into account if necessary.
Brightness value at the end of the disabling function	Basic brightness 5 % 10 % 15 % ... 95 % <b>100 %</b>	This parameter defines the brightness to be set at the end of the disabling function. The parameter is only visible on "Behaviour at end of disabling function = Brightness value".
Behaviour for forced position "switch on, active"		If the forced position is activated and forced-position state is "ON", you can define here how the dimming channel should behave.

		<p>This parameter is only visible when the forced position function is enabled.</p>
	Brightness value	<p>The dimming channel is set to the predefined brightness value. The assigned relay switches on.</p>
	No reaction	<p>Bus operation of the dimming channel is locked. The control voltage remains the same and the relay is switched to the most recently switching state defined by bus operation. This ensures that relays altered by a manual operation are in the right switching state. If the relays are already in the correct position, then the actuator does not react.</p>
	Memory value (brightness bef. switch. off last time)	<p>The active and internally stored brightness value prior to the last switch-off is set (via the "Switching" or "Central switching" object). After programming with the ETS, the value is predefined to maximum brightness. Only a bus voltage failure, however, does not delete the memory value.</p>
Brightness for forced position "switch on, active"	<p>Basic brightness</p> <p>5 %</p> <p>10 %</p> <p>15 %</p> <p>...</p> <p>95 %</p> <p><b>100 %</b></p>	<p>This parameter defines the brightness to be set if a forced position is active. The parameter is only visible on "Behaviour for forced position 'active, switch on' = Brightness value".</p>
Behaviour for forced position "active, switch off"	<b>Switch off</b>	<p>If the forced position is activated and forced-position state is "OFF", the dimming channel is always switched off. This parameter cannot be edited and is only visible when the forced position function is enabled.</p>
Behaviour for forced position end "inactive"		<p>The behaviour of the dimming channel at the end of the forced-position can be configured here. This parameter is only visible when the forced position function is enabled.</p>
	No reaction	<p>The brightness value and relay are moved to the state set at the beginning of the restraint. If, during the forced position, the relays were not moved manually, the actuator will not show any switching reaction. Otherwise, the relay switches to the specified position.</p>
	<b>tracked brightness value</b>	<p>At the end of a forced position, the state received during the forced position function or adjusted before the function can be tracked with the appropriate</p>

		brightness value. Any time functions still in progress will also be taken into account if necessary.
Behaviour after bus voltage return		The forced position communication object can be initialised after bus voltage return. The brightness status of the dimming channel can be influenced when the forced position function is activated. This parameter is only visible when the forced position function is enabled.
	<b>no forced position</b>	The force-independent parameter "Behaviour after bus voltage return" (parameter page "Ex - General") will be executed on return of bus voltage.
	Forced position active, switch on	The forced position is activated. The dimming channel is switched on to the brightness value predefined by the parameter "Behaviour for forced position 'active, switch on'".
	Forced position active, switch off	The forced position is activated. The dimming channel is switched off under forced control.
	State before bus voltage failure	After bus voltage return, the forced position state last selected and internally stored before bus voltage failure will be tracked. An ETS programming operation deletes the stored state (reaction in that case same as with "no forced position active"). If the tracked state corresponds to "No forced position", the force-independent parameter "Behaviour after bus voltage return" (parameter page "Ex - General") will be executed on return of bus voltage. If the forced position is activated, the dimming channel is switched on to the brightness value predefined by the parameter "Switch on behaviour for forced position 'active'".
Logic operation function?	yes	This parameter can be used to enable the logic operation function (setting "yes"). The parameter is preset to "No" if the staircase function is enabled.
	<b>no</b>	
Type of logic operation function	<b>OR</b>	This parameter defines the logical type of the logic operation function. The object "logic operation" is linked to the logic switching state of the dimming channel (object "switching" after evaluation of configured time delays if necessary) using the logic operation function set here.
	AND	
	AND with feedback	



		This parameter is only visible when the logic operation function is enabled.
Object value of logic operation obj. after bus voltage return	<b>0 (OFF)</b> 1 (ON)	After bus voltage return, the object value of the logic operation object is initialised here with the preset value. This parameter is only visible when the logic operation function is enabled.
Object value of logic operation obj. after ETS download	<b>0 (OFF)</b> 1 (ON)	After programming the application or the parameters in the ETS, the object value of the logic operation object is initialised here with the preset value. This parameter is only visible when the logic operation function is enabled.
<input type="checkbox"/> Ex-Dimming characteristic		
Characteristic curve		
	<b>linear</b>	The dimming characteristic curve of the dimming channel can be set here. User-defined characteristics allow the adjustment of brightness changes for time-controlled dimming operations. This means that - depending on the luminaire used - it is possible to adjust dimming operations to the brightness perception of the human eye.
	User-defined (2 ranges) User-defined (3 ranges) User-defined (4 ranges) User-defined (5 ranges)	The dimming characteristic is linear. During every relative or absolute dimming procedure, the entire brightness range is dimmed with the configured dimming increment speed.  The brightness curve between basic brightness / minimum brightness and maximum brightness can be adapted individually. For this purpose, the brightness range is subdivided in up to 5 sections. Each section can be configured with an independent dimming speed.
Range I Time between two dimming increments (1...255 ms)	<b>1...25...255</b>	In the case of a linear characteristic curve, the dimming increment speed is set here (time between two dimming values) for the entire dimming range. In the case of a user-defined characteristic curve, the dimming increment speed of the first section is set here.
Brightness limiting value Range I -> II	Basic brightness 5 % 10 % ...	The first brightness limiting value is configured here. This limiting value defines the boundary between the first and second section.

	<p><b>25 %</b> ... 95 % 100 %</p>	<p>Only visible if "characteristic curve = "user-defined".</p>
<p>Range II Time between two dimming increments (1...255 ms)</p>	<p>1...<b>20</b>...255</p>	<p>In the case of a user-defined characteristic curve, the dimming increment speed of the second section is set here. Only visible if "characteristic curve = "user-defined".</p>
<p>Brightness limiting value Range II -&gt; III</p>	<p>Basic brightness 5 % 10 % ... <b>50 %</b> ... 95 % 100 %</p>	<p>The second brightness limiting value is configured here. This limiting value defines the boundary between the second and third section. Only visible if "characteristic curve = "user-defined" with at least two limiting values.</p>
<p>Range III Time between two dimming increments (1...255 ms)</p>	<p>1...<b>15</b>...255</p>	<p>In the case of a user-defined characteristic curve, the dimming increment speed of the third section is set here. Only visible if "characteristic curve = "user-defined" with at least two limiting values.</p>
<p>Brightness limiting value Range III -&gt; IV</p>	<p>Basic brightness 5 % 10 % ... <b>75 %</b> ... 95 % 100 %</p>	<p>The third brightness limiting value is configured here. This limiting value defines the boundary between the third and fourth section. Only visible if "characteristic curve = "user-defined" with at least three limiting values.</p>
<p>Range IV Time between two dimming increments (1...255 ms)</p>	<p>1...<b>10</b>...255</p>	<p>In the case of a user-defined characteristic curve, the dimming increment speed of the fourth section is set here. Only visible if "characteristic curve = "user-defined" with at least three limiting values.</p>
<p>Brightness limiting value Range IV -&gt; V</p>	<p>Basic brightness 5 % 10 % ... <b>90 %</b> ... 95 %</p>	<p>The fourth brightness limiting value is configured here. This limiting value defines the boundary between the fourth and fifth section. Only visible if "Characteristic curve = user-defined" with at least four limiting values.</p>

100 %

Range IV  
Time between two  
dimming increments  
(1...255 ms)

1...**5**...255

In the case of a user-defined characteristic curve, the dimming increment speed of the fifth section is set here.  
Only visible if "Characteristic curve = user-defined" with at least four limiting values.

## 4.2.5.3 Parameters of the independent switching channels

Description	Values	Comment
<p>☐ Ax-General</p>		
Name of the switching channel	20-character free text	<p>The text entered in this parameter is applied to the name of the parameter page and is used to label the switching channel in the ETS parameter window (e.g. "Lighting, kitchen", "Path illumination").</p> <p>The text is not programmed in the device.</p>
Operating mode	<b>NO contact</b>	<p>The relay of a switching output can be configured as NO or NC contacts. In this way, the inversion of switching states is possible.</p> <p>Switching state = OFF ("0") -&gt; Relay contact opened Switching state = ON ("1") -&gt; Relay contact closed</p>
	NC contact	<p>Switching state = OFF ("0") -&gt; Relay contact closed Switching state = ON ("1") -&gt; Relay contact opened</p>
Behaviour after ETS programming	close contact	The relay contact is closed. If the relay is already in the correct position, then the actuator does not react.
	open contact	The relay contact is opened. If the relay is already in the correct position, then the actuator does not react.
	<b>No reaction</b>	After an ETS programming operation, the relay is switched to the most recently switching state defined by bus operation. This ensures that relays altered by a manual operation are in the right switching state. If the relay is already in the correct position, then the actuator does not react.
	As response to bus voltage return	After an ETS programming operation, the switching channel will behave in the manner defined in the parameter "Behaviour after bus voltage return". If the behaviour there is configured to "State as before bus voltage failure", then that switching state is also set after an ETS programming operation which was active at the time of the last bus

		voltage failure. An ETS programming operation does not overwrite the saved switching state.
Behaviour in case of bus voltage failure		The actuator permits setting of the reaction separately for each switching channel in case of bus voltage failure.
	close contact	The relay contact is closed. If the relay is already in the correct position, then the actuator does not react.
	open contact	The relay contact is opened. If the relay is already in the correct position, then the actuator does not react.
	<b>No reaction</b>	If there is a bus voltage failure, the relay is switched to the switching state most recently defined by bus operation. This ensures that relays altered by a manual operation are in the right switching state. If the relays are already in the correct position, then the actuator does not react.
Behaviour after bus voltage return		The actuator allows the reaction to be set separately for each switching channel after bus voltage return.
	close contact	The relay contact is closed. If the relay is already in the correct position, then the actuator does not react.
	open contact	The relay contact is opened. If the relay is already in the correct position, then the actuator does not react.
	<b>State before bus voltage failure</b>	After bus voltage return, the switching state last set and internally stored before bus failure will be tracked.
	No reaction	After bus voltage return, the brightness value and relay are brought into the state set on bus voltage failure (in accordance with the parameter "Behaviour on bus voltage failure"). If, during the bus failure, the relay was not moved manually, the actuator will not show any switching reaction. Otherwise, the relay switches to the specified position.
	Activating staircase function	The staircase function is – irrespective of the "Switching" object - activated after bus voltage return. This setting is only available when the staircase function is enabled.

<p>Assignment to cyclical monitoring?</p>		<p>The actuator offers the option of monitoring individual switching channels cyclically for the arrival of switching telegrams. In this way, the objects which must be updated cyclically by the KNX can be monitored. In so doing, the polarity of the telegram update ("0" or "1") is insignificant. If there is no update of the monitored objects within a specifically configured monitoring time, then the affected switching channels set themselves to the preferred predefined contact position. However, this does not disable the channels, so that, after the reception of a further switching telegram, the new switching state is set at the output.</p>
	no	Cyclical monitoring is deactivated.
	yes, "ON" when time has elapsed	Cyclical monitoring is activated. After the time has elapsed, the switching channel is switched on.
	yes, "OFF" when time has elapsed	Cyclical monitoring is activated. After the time has elapsed, the switching channel is switched off.
<p>Assignment to central function 1?</p>	<p>yes no</p>	<p>This parameter determines the assignment of the switching channel to the first central function. This parameter is visible only if the first central function is enabled (parameter page "General").</p>
<p>Assignment to central function 2?</p>	<p>yes no</p>	<p>This parameter determines the assignment of the switching channel to the second central function. This parameter is visible only if the second central function is enabled (parameter page "General").</p>
<p>Assignment to central function 3?</p>	<p>yes no</p>	<p>This parameter determines the assignment of the switching channel to the third central function. This parameter is visible only if the third central function is enabled (parameter page "General").</p>
<p><input type="checkbox"/> Ax-Enabled functions</p>		
<p>Feedback telegrams</p>	<p><b>Disabled</b>  enabled</p>	<p>This parameter can be used to disable or to enable the feedback functions. When the function is enabled, the required parameters will be displayed under "Ax –Feedbacks".</p>

Time delays	<b>Disabled</b> enabled	This parameter can be used to disable or to enable the time delays. When the function is enabled, the required parameters will be displayed under "Ax – Time delays". The parameter is preset to "Disabled" if cyclical monitoring is enabled.
Staircase function	<b>Disabled</b> enabled	This parameter can be used to disable or to enable the staircase function. When the function is enabled, the corresponding parameters will be displayed under "Ax Staircase function" and the necessary objects enabled. The parameter is preset to "Disabled" if cyclical monitoring is enabled.
Scene function	<b>Disabled</b> enabled	This parameter can be used disable or to enable the scene function. When the function is enabled, the corresponding parameters will be displayed under "Ax - Scene function" and the necessary objects are enabled. The parameter is preset to "Disabled" if cyclical monitoring is enabled.
Operating hours counter	<b>Disabled</b> enabled	The operating hours counter can be disabled or enabled here. When the function is enabled, the required parameters will be displayed under "Ax – Operating hours counter".
<input type="checkbox"/> Ax-Feedback telegrams Feedback switching status?	<b>none</b>  no inversion, active signalling object  no inversion, passive status object	The current switching state of the switching channel can be reported separately back to the bus.  The switching status feedback of the affected switching channel is deactivated.  A switching status is transmitted as soon as it is updated. An automatic telegram transmission of the feedback takes place after bus voltage return or after programming with the ETS. The switching status is written to the object in non-inverted form.  A switching status will be transmitted in response only if the feedback object is read out from by the bus. No automatic telegram transmission of the feedback takes place after bus voltage return or after programming with the ETS. The switching status is written to the object in non-inverted form.

inversion, active signalling object	A switching status is transmitted as soon as it is updated. An automatic telegram transmission of the feedback takes place after bus voltage return or after programming with the ETS. The switching status is written to the object in inverted form.
inversion, passive status object	A switching status will be transmitted in response only if the feedback object is read out from by the bus. No automatic telegram transmission of the feedback takes place after bus voltage return or after programming with the ETS. The switching status is written to the object in inverted form.
Updating the object value for switching status feedback	Here, you can specify when the actuator should update the feedback value for the switching status (object "Switching feedback") in case of an actively transmitting communication object. The object value updated by the actuator is then signalled actively to the bus. This parameter is only visible in case of an actively transmitting feedback.
after each update obj. "Switching"/"Central"	The actuator updates the feedback value in the object once a new telegram is received on the input objects "Switching" or "Central switching" or the switching state changes internally (e.g. through a time function). With an actively transmitting feedback object, a new telegram is also then actively transmitted to the bus each time. The telegram value of the feedback does not necessarily have to change in the process. Hence, a corresponding switching status feedback is also generated on the "Switching" object such as in the case of cyclical telegrams for example.
<b>only if the feedback value changes</b>	The actuator only updates the feedback value in the object if the telegram value (e.g. "OFF" to "ON") also changes or the switching state changes internally (e.g. through a time function). If the telegram value of the feedback does not change (e.g. in the case of cyclical telegrams to the "Switching" object with the same telegram value), the actuator does not transmit any feedback. Consequently, with an actively transmitting feedback object, no telegram with the same content will be transmitted repeatedly either.



<p>Time delay for feedback telegram after bus voltage return ?</p>	<p><b>yes</b> <b>no</b></p>	<p>The states of the switching status feedback can be transmitted to the bus with a delay after bus voltage return or after an ETS programming operation. The "Yes" setting activates the delay time in case of bus voltage return. The delay time is configured on the parameter page "Times". This parameter is only visible in case of an actively transmitting feedback.</p>
<p>Cyclical transmission of the feedback?</p>	<p><b>yes</b> <b>no</b></p>	<p>The switching status feedback telegrams can, if actively transmitting, also be transmitted cyclically, in addition to the transmission after updating. This parameter is only visible in case of an actively transmitting feedback.</p> <p>Cyclical transmission is activated.</p> <p>Cyclical transmission is deactivated so that the feedback is transmitted to the bus only when updated by the actuator.</p>
<p>☐ Ax-Time delays</p>		
<p>Selection of time delay</p>	<p><b>no time delay</b></p> <p>Switch-on delay</p> <p>Switch-off delay</p> <p>ON delay and OFF delay</p>	<p>The "switching" communication object can be evaluated with a time delay. By this setting the desired function of the time delay is selected and the additional parameters of the delay enabled.</p>
<p>Switch-on delay Minutes (0...59)</p>	<p><b>0...59</b></p>	<p>This parameter is used for setting the duration of the switch-on delay.</p> <p>Sets the switch-on delay minutes.</p>
<p>Seconds (0...59)</p>	<p><b>0...10...59</b></p>	<p>Sets the switch-on delay seconds.</p>
<p>Switch-on delay retriggerable?</p>	<p><b>yes</b> <b>no</b></p>	<p>A switch-on delay still in progress can be retriggered (setting "yes") by another "ON" telegram. Alternatively, the retriggering time can be suppressed (setting "no").</p> <p>The parameters for the switch-on delay are only visible if switch-on delay or switch-on and switch-off delay are activated.</p>
<p>Switch-off delay Minutes (0...59)</p>	<p><b>0...59</b></p>	<p>This parameter is used for setting the duration of the switch-off delay.</p> <p>Sets the switch-off delay minutes.</p>

Seconds (0...59)	0... <b>10</b> ...59	Sets the switch-off delay seconds.
Switch-off delay retriggerable?	yes <b>no</b>	A switch-off delay still in progress can be retriggered (setting "yes") by another "OFF" telegram. Alternatively, the retriggering time can be suppressed (setting "no").  The parameters for the switch-off delay are only visible if switch-on delay or switch-on and switch-off delay are activated.
☐ Ax-Staircase function		
Staircase time Hours (0...23)	<b>0</b> ...23	This parameter is used for programming the duration of the switch-on time for a scene recall.  Switch-on time hours setting.
Minutes (0...59)	0... <b>3</b> ...59	Switch-on time minutes setting.
Seconds (0...59)	<b>0</b> ...59	Switch-on time seconds setting.
Staircase time retriggerable	<b>yes</b>  no	An active switch-on time can be retriggered (setting "yes"). Alternatively, the retriggering time can be suppressed (setting "no"). This parameter is preset to "no" if the supplementary function "Time extension" is configured. Re-triggering will not be possible.
Reaction to OFF-telegram	<b>switch off</b>    ignore	An active switch-on time can be aborted prematurely by switching off the staircase function.  The switch-on time is aborted after receipt of an OFF telegram on the object "Staircase time start/stop". With the supplementary function "Time preset via the bus" and the setting "Staircase function activatable via object 'Staircase time' ? = yes", the switch-on time can also be prematurely ended by a factor of "0".  OFF Telegrams or "0" factors are ignored. The switch-on time will be executed completely to the end.
Supplementary function for staircase function		The staircase function can be extended by the two supplementary functions "Time extension" and "Time specifications via bus", which should be used alternatively.

		<p>This parameter enables the desired supplementary function and thereby activates the necessary parameters or objects.</p> <p>No supplementary function is enabled.</p> <p>The time extension is activated. This function permits retriggering an activated staircase lighting time span-times via the object "Staircase function start/stop".</p> <p>The time preset via the bus is activated. With this supplementary function, the configured switch-on time can be multiplied by a factor received via the KNX, thus it can be adapted dynamically.</p>
	<p><b>No supplementary function</b></p> <p>time extension</p> <p>Time preset via the bus</p>	
Maximum time extension	<p><b>1-fold time</b></p> <p>2-fold time</p> <p>3-fold time</p> <p>4-fold time</p> <p>5-fold time</p>	<p>In case of a time extension (retriggering the lighting time n-times via the object "Staircase function start/stop), the parameterized staircase lighting time will be extended by the value programmed in this parameter.</p> <p>"1-fold time" means that after the started staircase time has elapsed, it can be retriggered a maximum of one more time. The time is therefore extended two fold. The other settings behave in a similar manner.</p> <p>This parameter is visible only if the supplementary function "time extension" is set.</p>
Staircase function activatable via "Staircase time" object?	<p>yes</p> <p>no</p>	<p>A time preset via the bus can specify here whether the receipt of a new time factor also starts the switch-on time (setting "yes"). At the same time, the object "Staircase function start/stop" is hidden.</p> <p>If the setting is "no", the switch-on time can be activated exclusively via the object "Staircase function start/stop". This parameter is visible only if the supplementary function "Time preset via the bus" is set.</p>
Activate the switch-on delay for the staircase function?	<p>yes</p>	<p>The staircase function enables the activation of an own switch-on delay. This switch-on delay affects the trigger result of the staircase function and thus delays the switch-on.</p> <p>The switch-on delay for the staircase function is enabled. After reception of an ON telegram on the object "Staircase</p>

		function start/stop", the switch-on delay is started. Another ON-telegram triggers the time only when the parameter "Switch-on delay retriggerable?" is set to "yes". The staircase time is activated and the output is switched on only after the time delay has elapsed.
	<b>no</b>	The switch-on delay is deactivated. After reception of an ON telegram on the object "Staircase function start/stop", the staircase time is activated immediately and the output switched on.
Switch-on delay Hours (0...23)	<b>0...23</b>	This parameter is used for setting the duration of the switch-on delay.
		Sets the switch-on delay hours.
Minutes (0...59)	<b>0...59</b>	Sets the switch-on delay minutes.
Seconds (0...59)	<b>0...30...59</b>	Sets the switch-on delay seconds.
Switch-on delay retriggerable ?	<b>yes</b>	An active switch-on delay can be retriggered (setting "yes"). Alternatively, the retriggering time can be suppressed (setting "no").
	<b>no</b>	<p><b>i</b> This parameter is preset to "no" if the supplementary function "Time extension" is configured. Retriggering will not be possible.</p> <p><b>i</b> The parameters for the switch-on delay are only visible when the parameter "Activate switch-on delay for the staircase function?" is configured to "yes".</p>
Reaction at the end of the staircase time	<b>switch off</b>	At the end of the switch-on time, the actuator for the switching channel concerned displays the configured behaviour here. The channel can be set to switch off immediately or alternatively to execute a pre-warning function.
	Activate pre-warning time	At the end of the switch-on time, the actuator switches off the switching channel concerned.
		At the end of the switch-on time, the switching channel can generate a pre-warning prior to switching off. The pre-warning, for example, should warn any person still on the staircase that the light will soon be switched off.
Pre-warning time Minutes (0...59)	<b>0...59</b>	This parameter is used for setting the duration of the pre-warning time. The pre-warning time is added to the switch-on time.
		Sets the pre-warning time in minutes.

Seconds (0...59)	0... <b>30</b> ...59	Sets the pre-warning time in seconds. These parameters are visible only if the pre-warning function is enabled.
Number of pre-warnings(1...10)	1... <b>3</b> ..10	This parameter defines how often the switching channel is to switch off within the pre-warning time. i.e. how many pre-warnings will be generated.
Time for pre-warning interruptions Seconds (0...59)	<b>0</b> ...59	This parameter defines the duration of a pre-warning interruption, i.e. how long the switching channel is to remain off during a pre-warning interruption. The time should be customized individually to the switch-off behaviour of the lamp used.
Milliseconds (0...9 x 100)	0... <b>5</b> ...9	Sets the pre-warning interruption seconds. Sets the pre-warning interruption milliseconds.
<input type="checkbox"/> Ax-Scene function Delay scene recall?	yes <b>no</b>	A scene is recalled via the scene extension object. If needed, the scene recall on the actuator can be made with a delay after reception of a recall telegram (setting: "yes"). Alternatively, recall takes place immediately on reception of the telegram (setting: "no").
Delay time Minutes (0...59)	<b>0</b> ...59	This parameter is used for setting the duration of the scene delay time.
Seconds (0...59)	0... <b>10</b> ...59	Sets the scene delay time in minutes. Sets the scene delay time in seconds.
Overwrite values stored in the device during ETS download?	<b>yes</b> no	<b>i</b> The delay time parameters are only visible, if the parameter "Delay scene recall ?" is configured to "yes". During storage of a scene, the scene values (current states of the switching channels concerned) are stored internally in the device. To prevent the stored values from being replaced during an ETS programming operation by the originally programmed scene values, the actuator can inhibit

		overwriting of the scene values (setting: "no"). As an alternative, the original values can be reloaded into the device during each ETS programming operation (setting: "yes").
Use extended scene recall?	yes  no	The extended scene recall allows polling of the 10 scenes of the switching channel in sequence. Here, scene recall takes place via the 1-bit communication object "Extended scene recall". Each ON telegram received via this object recalls the next scene. Each OFF telegram received recalls the previous scene. This parameter enables extended scene recall, if required.
Scene X activatable by scene number (scene number "0" = scene deactivated)  X = depending on the scene (1...10)	0...1*...64  *: The predefined scene number is dependent on the scene (1...10).	The actuator distinguishes between up to 10 different scenes which are recalled via the scene extension object or stored. The datapoint type of the extension object, however, permits addressing a maximum of 64 scenes. This parameter defines the scene number (1...64) which is used to address the internal scene (1...10). A setting of "0" deactivates the corresponding scene.
Switching state for scene X  X = depending on the scene (1...10)	switch on <b>switch off</b>	This parameter is used for configuring the switching state which is set when the scene is recalled.
Storage function for scene X  X = depending on the scene (1...10)	yes  no	Setting "yes" enables the storage function of the scene. If the function is enabled, the current switching state can be stored internally via the extension object on receipt of a storage telegram. If "no" is selected, the storage telegrams are rejected.
<input type="checkbox"/> Ax-Operating hours counter		
Operating hours counter	<b>Disabled</b>  enabled	The operating hours counter can be enabled here. The operating hours counter determines the switch-on time of a relay. A relay output is actively on, when the relay contact is closed, i.e. when current is flowing to the load. In consequence, a closed contact is always evaluated, irrespective of the set relay operating mode for independent switching channels (NO or NC contact)

		<p>and the logical feedback of the switching status. Once the operating hours counter is enabled, the operating hours will be determined and added up by the ETS immediately after commissioning the actuator.</p> <p>If the operating hours counter is subsequently disabled again in the parameters and the actuator is programmed with this disabling function, all operating hours previously counted for a relay output will be deleted. When enabled again, the counter reading of the operating hours counter is always on "0 hours".</p> <p>Depending on activation by dimming channels or independent switching channels, the operating hours counter of a relay is activated on different parameter pages. This parameter is only available when a dimming channel independently affects one relay output. If a switching channel affects a relay, the operating hours counter must be activated on the parameter page "Ax - Enabled functions".</p>
Type of counter	<p><b>Up-counter</b></p> <p>Down-counter</p>	<p>The operating hours counter can be configured as an up-counter or down-counter. The setting here influences the visibility of the other parameters and objects of the operating hours counter.</p>
Start/Limiting value presetting?	<p><b>no</b></p> <p>yes, as received via object</p> <p>yes, as specified in parameter</p>	<p>If the down-counter is used, a start value can optionally be predefined. If the up-counter is used, a limiting value can optionally be predefined. This parameter defines whether the start or limiting value can be set via a separate parameter or adapted individually by a communication object from the bus. The setting "no" deactivates the start / limiting value.</p>
Start/limiting value (0...65535 hrs.)	<p>0...<b>65535</b></p>	<p>The start value of the down-counter or the limiting value of the up-counter is set here.</p> <p>This parameter is only visible if the parameter "Start / limiting value specification ?" is set to "Yes like the parameter".</p>
Automatic transmitting of the counter value		<p>The current meter reading of the operating hours counter can be transmitted actively to the bus via the</p>

		"value operating hours counter" communication object.
	cyclical	The meter reading is transmitted cyclically to the KNX and when there is a change. The cycle time is configured generally on the parameter page "Times".
	<b>after change by interval value</b>	The meter reading is transmitted to the bus only when there is a change.
Counting value interval (1...65535 h)	1...65535	The interval of the counter value is set here for automatic transmission. The current meter reading is transmitted to the KNX after the time value configured here. This parameter is only visible if the parameter "Automatic transmission of the number value" is set to "Change on interval value".
<input type="checkbox"/> Ax-Supplementary function		
Selection of supplementary function	<b>No supplementary function</b>	The supplementary function can be defined and enabled here. The disabling function is only configurable as an alternative to the forced position function.
	Disabling function	
	Forced position	
Polarity of the disabling object	<b>0 = disabled; 1 = enabled</b>  1 = enabled; 0 = disabled	This parameter defines the polarity of the disabling object. This parameter is visible only if the disabling function is enabled.
Behaviour at the beginning of the disabling function		The behaviour of the switching channel at the beginning of the disabling function can be configured. This parameter is visible only if the disabling function is enabled.
	No change to the switching state	The relay is switched to the most recently switching state defined by a bus operation. This ensures that relays altered by a manual operation are in the right switching state. If the relays are already in the correct position, then the actuator does not react.
	Switch off	At the beginning of the disabling function, the switching channel is switched off and locked.
	<b>Switch on</b>	At the beginning of the disabling function, the switching channel is switched on and locked.



	Flashing	The switching channel is switched on and off cyclically during the disabling. The "Time for flashing" is generally configured on the parameter page "Times". During flashing, the logical switching state of the switching channel is fed back as "Switched on".
Behaviour at the end of the disabling function		The behaviour of the switching channel at the end of the disabling function can be configured. This parameter is visible only if the disabling function is enabled.
	No change to the switching state	The relay is moved to the state set at the beginning of disabling. If, during the disabling function, the relays were not moved manually, the actuator will not show any switching reaction. Otherwise, the relay switches to the specified position.
	Switch off	At the end of the disabling function, the switching channel is switched off and enabled again.
	Switch on	At the end of the disabling function, the switching channel is switched on and enabled again.
	<b>Set tracked state</b>	The last switching state received during the disabling function or the switching state set before the disabling function will be tracked. Any time functions still in progress will also be taken into account if necessary.
	Flashing	The switching channel is switched on and off cyclically after the disabling. The flashing time is generally configured on the parameter page "Times". During flashing, the logical switching state of the channel is fed back as "Switched on". The flashing state remains active until another bus command is received and thereby predefines another switching state.
Behaviour for forced position "switch on, active"	<b>Switch on</b>	If the forced position is activated and restraint is "ON", the switching channel is always switched on. This parameter cannot be edited and is only visible when the forced position function is enabled.
	<b>Switch off</b>	If the forced position is activated and forced-position state is "OFF", the

Behaviour for forced position "active, switch off"	switching channel is always switched off. This parameter cannot be edited and is only visible when the forced position function is enabled.
Behaviour for forced position end "inactive"	The behaviour of the switching channel at the end of the forced-position can be configured here. This parameter is only visible when the forced position function is enabled.
<b>tracking the switching state</b>	The state received during the forced position function or the switching state set before the function can be tracked at the end of the forced position. Any time functions still in progress will also be taken into account if necessary.
No change to the switching state	The relay is moved to the state set at the beginning of the restraint. If, during the forced position, the relays were not moved manually, the actuator will not show any switching reaction. Otherwise, the relay switches to the specified position.
Switch off	At the end of the forced position, the switching channel is switched off and enabled again.
Switch on	At the end of the forced position, the switching channel is switched on and enabled again.
Behaviour after bus voltage return	The forced position communication object can be initialised after bus voltage return. The switching state of the switching channel can be influenced when the forced position function is being activated. This parameter is only visible when the forced position function is enabled.
<b>no forced position</b>	The force-independent parameter "Behaviour after bus voltage return" (parameter page "Ax - General") will be executed on return of bus voltage.
Forced position active, switch on	The forced position is activated. The dimming channel is switched on to the brightness value predefined by the parameter "Behaviour for forced position 'active, switch on'".
Forced position active, switch off	The forced position is activated. The dimming channel is switched off under forced control.
State before bus voltage failure	After bus voltage return, the forced position state last selected and internally

		<p>stored before bus voltage failure will be tracked. An ETS programming operation deletes the stored state (reaction in that case same as with "no forced position active"). If the tracked state corresponds to "No forced position", the force-independent parameter "Behaviour after bus voltage return" (parameter page "Ax - General") will be executed on return of bus voltage.</p>
Logic operation function?	<p>yes</p> <p><b>no</b></p>	<p>This parameter can be used to enable the logic operation function (setting "yes").</p> <p>The parameter is preset to "No" if the staircase function or cyclical monitoring is enabled.</p>
Type of logic operation function	<p><b>OR</b></p> <p>AND</p> <p>AND with feedback</p>	<p>This parameter defines the logical type of the logic operation function. The object "logic operation" is linked to the logic switching state of the switching channel (object "switching" after evaluation of the configured time delays if necessary) using the logic operation function set here.</p> <p>This parameter is only visible when the logic operation function is enabled.</p>
Object value of logic operation obj. after bus voltage return	<p><b>0 (OFF)</b></p> <p>1 (ON)</p>	<p>After bus voltage return, the object value of the logic operation object is initialised here with the preset value.</p> <p>This parameter is only visible when the logic operation function is enabled.</p>
Object value of logic operation obj. after ETS download	<p><b>0 (OFF)</b></p> <p>1 (ON)</p>	<p>After programming the application or the parameters in the ETS, the object value of the logic operation object is initialised here with the preset value.</p> <p>This parameter is only visible when the logic operation function is enabled.</p>

## 5 Appendix

### 5.1 Index

#### B

Basic brightness..... 37

#### C

central function..... 31

continuous light switching..... 61,91

continuous lighting..... 61,65

#### D

disabling..... 77,100

#### E

ETS search paths..... 13

#### F

Feedback brightness value..... 51

forced position function..... 77,100

#### L

logic operation..... 77,100

#### M

Minimum brightness..... 38

#### O

operating hours counter..... 104

#### P

pre-warning function..... 61,64

#### S

Safe-state mode..... 16

scenes..... 70,97

soft-functions..... 57

staircase function..... 61,91

Supplementary functions..... 77,100

Switching feedback..... 51

#### T

time extension function..... 67

time functions..... 56,90

**Gira**  
**Giersiepen GmbH & Co. KG**  
Elektro-Installations-  
Systeme

Industriegebiet Mermbach  
Dahlienstraße  
42477 Radevormwald

Postfach 12 20  
42461 Radevormwald

Deutschland

Tel +49(0)21 95 - 602-0  
Fax +49(0)21 95 - 602-191

[www.gira.de](http://www.gira.de)  
[info@gira.de](mailto:info@gira.de)