

Issue:
28.08.2015
22103100

Brightness controller Mini

Order No. 2210 00



Table of Contents

1	Product definition	3
1.1	Product catalogue	3
1.2	Function	3
1.3	Accessories	4
2	Installation, electrical connection and operation	5
2.1	Safety instructions	5
2.2	Device components	6
2.3	Fitting and electrical connection	7
2.4	Commissioning	12
2.5	Operation	13
3	Technical data	14
4	Software description	15
4.1	Software specification	15
4.2	Software "Brightness controller A01711"	16
4.2.1	Scope of functions	16
4.2.2	Notes on software	17
4.2.3	Object table	18
4.2.3.1	Objects for the sensor	18
4.2.3.2	Objects for the light control	19
4.2.3.3	Objects for the brightness limiting values	26
4.2.4	Functional description	30
4.2.4.1	Brightness sensor	30
4.2.4.2	Light control	34
4.2.4.2.1	Application basics	34
4.2.4.2.2	Operation of the light control	36
4.2.4.2.3	Brightness setpoint	37
4.2.4.2.4	Channel configuration	41
4.2.4.2.5	Control behaviour	45
4.2.4.2.6	Disabling function	54
4.2.4.2.7	Superimposed operation	56
4.2.4.2.8	Application examples	57
4.2.4.2.9	Behaviour after a device reset	59
4.2.4.3	Brightness limiting values	60
4.2.4.3.1	Limiting value definition	60
4.2.4.3.2	Limiting value presetting	62
4.2.4.3.3	Disabling function	64
4.2.4.4	General reset behaviour	65
4.2.4.5	Delivery state	66
4.2.5	Parameters	67
5	Appendix	94
5.1	Index	94

1 Product definition

1.1 Product catalogue

Product name: Brightness controller Mini

Use: Physical sensor

Design: Installation
Flush-mounted with flush-mounting kit (accessories)
Surface-mounted with surface-mounting kit (accessories)

Order No. 2210 00

1.2 Function

Application

The brightness controller is installed on a horizontal ceiling and measures the reflected brightness of an area located below it. The device is used for the requirement-orientated control of lighting systems in interior rooms and, due to its compact design, is suitable both for ceiling mounting (clamping mounting) in dry false ceilings and for ceiling mounting in flush or surface-mounted appliance boxes (accessory).

Brightness sensor

To determine the workplace brightness or ambient brightness, the device possesses a brightness sensor, located behind the lens. The sensor detects the reflected mixed light composed of artificial light and daylight from the area or objects below the device. A reflection coefficient programmed at the factory enables the device to determine the effective brightness of the workplace surface or floor surface. The reflection coefficient of the device can be adapted to other workplace or floor surfaces by using the calibration function if required.

The brightness value determined by the device can be made available to other bus subscribers via an object for the purpose of display or evaluation. In addition, the brightness controller has up to three mutually independent brightness limiting values that are continuously compared with the detected brightness value. If a limiting value configured in the ETS or predefined externally is exceeded or fallen below, the device can transmit switching, brightness value or scene recall telegrams to the bus and thus trigger appropriate reactions in other bus subscribers.

Light control

A complete and multi-functional light control can be implemented in the brightness controller. The light control makes it possible to keep the brightness level of an assigned lighting device constantly at a preset brightness setpoint even under changing external light influences (daylight and/or artificial light). The light control is activated and deactivated by means of presence information. This presence information is transmitted from another bus subscriber

(e.g. another presence detector, motion detector or pushbutton) to the light control.

The light control makes it possible to control up to three separate dimming channels and allows extensive adjustment of the brightness setpoint even during ongoing operation of the device (setpoint shift, external presetting, Teach). Startup control phase, control phase and step down control phase can be adjusted individually to the control requirement.

Installation

The device is supplied via the bus voltage. An additional power supply is not necessary.

1.3 Accessories

Mounting kit for flush-mounted installation
Mounting kit for surface-mounted installation

Order No. 2241 00
Order No. 2242 00

2 Installation, electrical connection and operation

2.1 Safety instructions

Electrical equipment may only be installed and fitted by electrically skilled persons.

Failure to observe the instructions may cause damage to the device and result in fire and other hazards.

Do not open device or operate it beyond the technical specification.

Do not press on the sensor window. Device can be damaged.

The device is not suitable for use as a burglar alarm or other alarm.

Caution. Damage to sensors may result due to high thermal radiation. Avoid direct sunlight penetration in the sensor window.

2.2 Device components

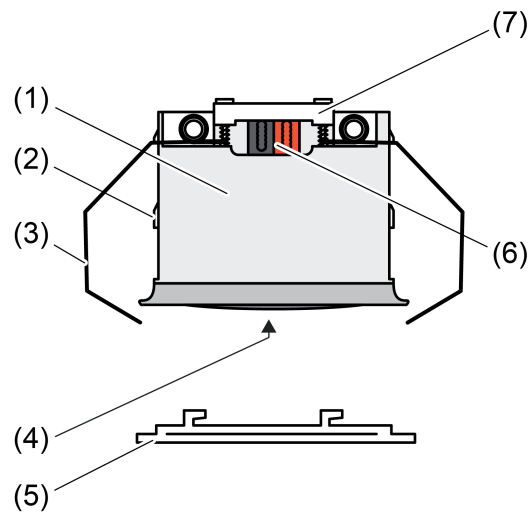

Figure 1: Device components

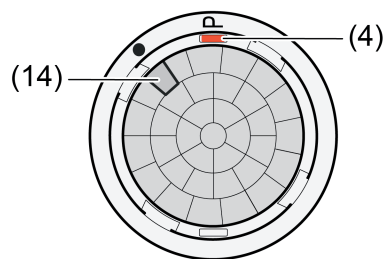

Figure 2: Top view

- (1) Brightness controller
- (2) Guide for clamping springs
- (3) Spring clamp
- (4) Programming button (red)
- (5) Design ring
- (6) KNX bus connection
- (7) Cable fixation
- (14) Brightness sensor

2.3 Fitting and electrical connection

Aligning the device

The brightness controller (1) is ideally mounted on the ceiling above a workplace or a bright surface. The device measures the reflected brightness (mixed light of artificial light and daylight) of the areas beneath. The brightness sensor (14) is attached on the side in the sensor housing and thus enables an asymmetric measuring surface. In this way, for example, it is possible to include several work places in the measurement without any laterally entering light distorting the measurement.

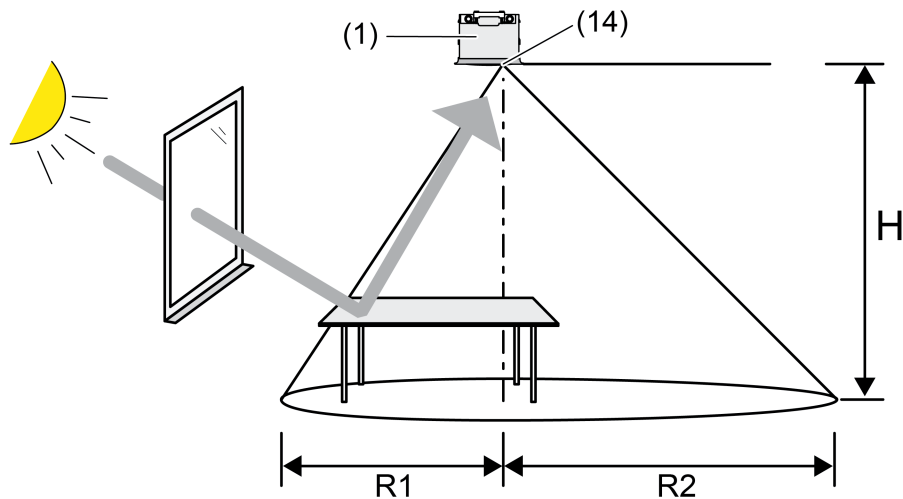

Figure 3: Alignment of the brightness sensor

- Select a vibration-free installation location. Strong vibrations can lead to varying brightness measurements.
- When mounting, align the device so that the brightness sensor (14) is not facing the window.
- i** Already pay attention to correct alignment when mounting.
- i** To avoid unfavourably influencing the brightness measurement, care must already be taken when mounting the device to ensure that no direct light falls onto the lens (e.g. through sunlight or direct lighting aligned upwards). Strong reflections can also influence the brightness measurement if they fall directly onto the device lens.

Installation height H	R1	R2
2.20 m	1.5 m	2.3 m
2.50 m	1.8 m	2.6 m
3.00 m	2.0 m	3.0 m
3.50 m	2.5 m	3.6 m
4.00 m	2.8 m	4.2 m
5.00 m	3.5 m	5.2 m

Radii of the asymmetrical measuring area, dependent on the installation height

Connecting and mounting the device in the suspended ceiling

In the delivered state, the device is prepared for mounting in a suspended ceiling. The spring clamps are premounted.

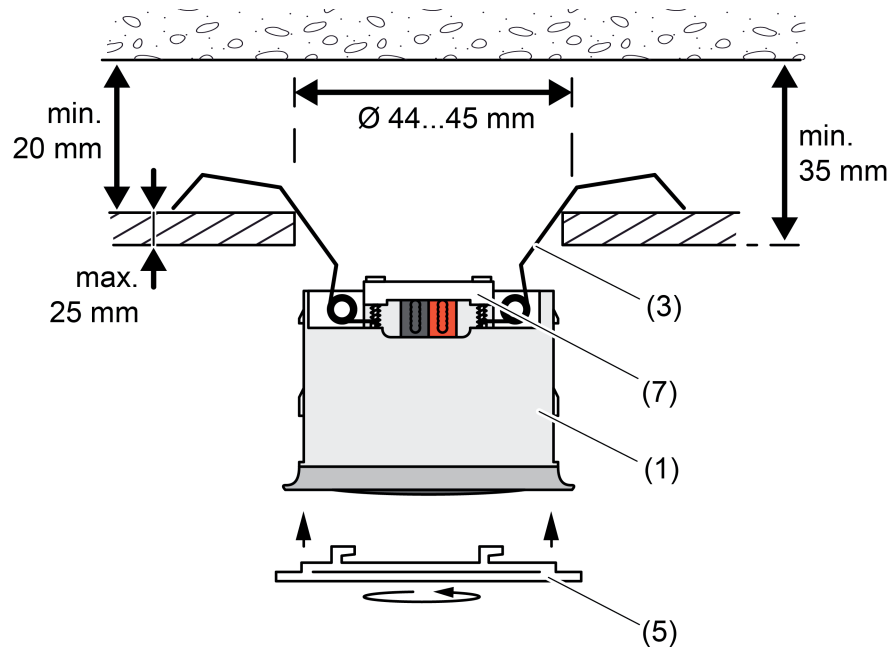

Figure 4: Mounting in a suspended ceiling

Max. thickness of the suspended ceiling approx. 25 mm. Installation depth min. 35 mm. Distance between concrete ceiling and suspended ceiling min. 20 mm. Ceiling cut-out 44 ... 45 mm.

- Connect the KNX bus line.
- Clamp the KNX bus line with cable fixation (7).
- Bend back the spring clamps (3) and push the brightness controller (1) into the suspended ceiling.
- Attach the large design ring (5) and rotate it in clockwise direction.

Mounting in combination with the mounting kit for flush or surface-mounted box mounting

For mounting in a flush or surface-mounted box, it is necessary to dismantle the premounted spring clamp and mount the clamping springs. The clamping springs are contained in the mounting kits (see accessories).

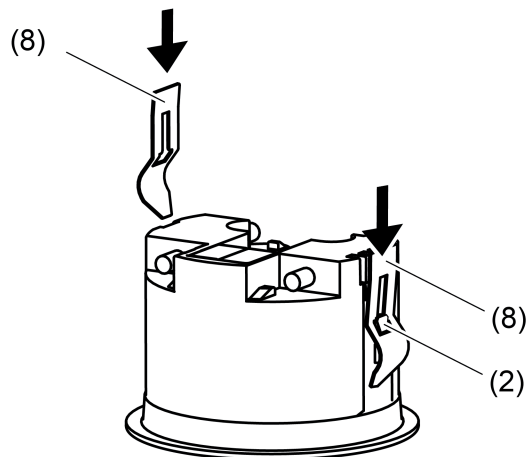

Figure 5: Mounting the clamping springs as preparation for flush or surface box mounting

- Remove spring clamp.
- Push the clamping springs (8) in the right orientation on the side guides (2) from behind until they snap into place.

Connecting and fitting the device in a flush-mounted box

The clamping springs must have been mounted in advance.

A suitable flush-mounted appliance box is mounted in the ceiling at the designated installation location.

The large design ring is included in the mounting kit for flush box mounting (see accessories).

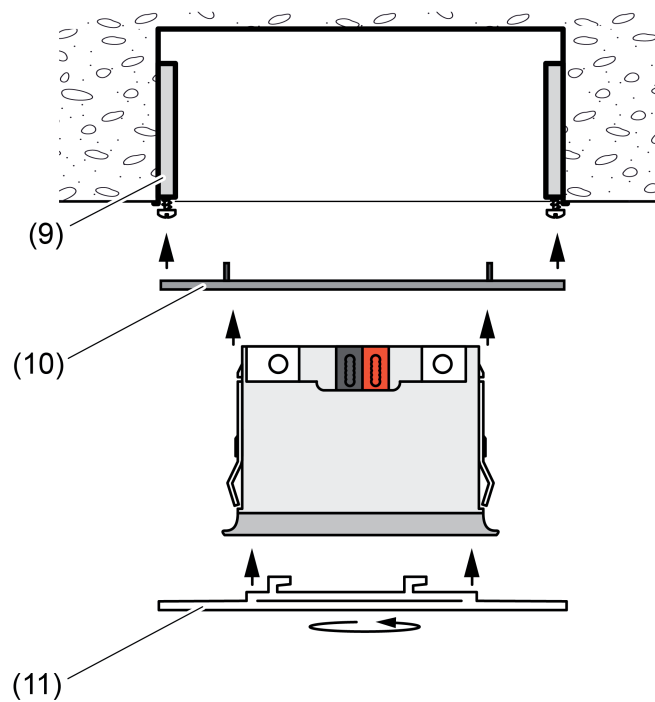

Figure 6: Mounting in a flush-mounted/cavity wall appliance box

- Mount supporting frame (10) on the flush-mounted boxes (9).
- Connect the KNX bus line.
- Snap the brightness controller into the supporting frame.
- Attach the large design ring (11) and rotate it in clockwise direction.

Connecting and fitting device in a surface-mounted housing

The clamping springs must have been mounted in advance.

Use the surface-mounted housing contained in the mounting kit for surface box mounting.

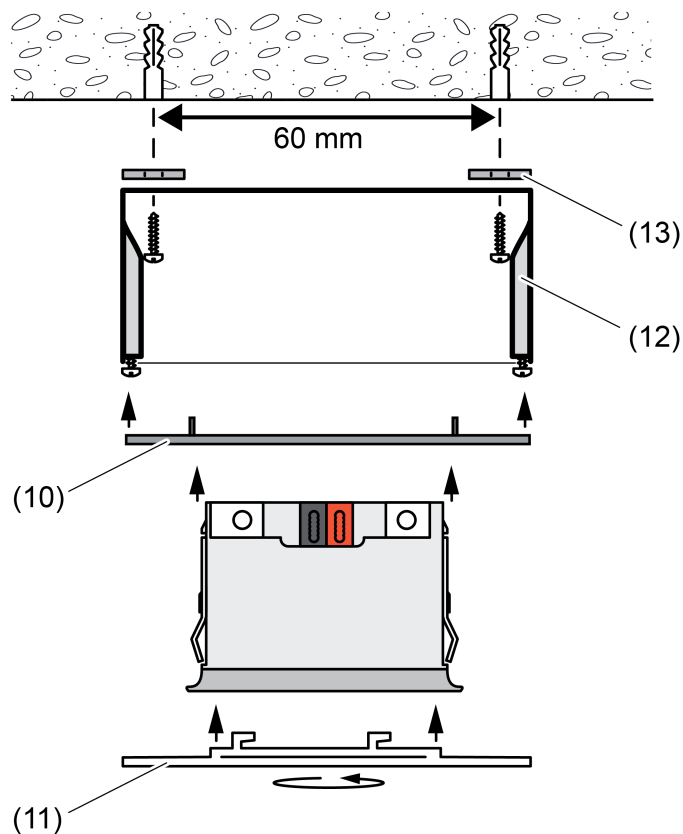

Figure 7: Mounting in the flush-mounted housing (accessories)

- In humid environments and for IP44 mounting: Insert the supplied seals (13) into the screw holes of the surface-mounted housing (12).
- Seal the cable entry with the supplied rubber grommet. Cut the rubber grommet appropriately for the bus cable. Route the bus line into the box.
- Mount the surface-mounted housing on the room ceiling at the designated installation location.
Hole spacing 60 mm.
- Mount the supporting frame (10) on the surface-mounted housing (12).
- Connect the KNX bus line.
- Snap the brightness controller into the supporting frame.
- Attach the large design ring (11) and rotate it in clockwise direction.

2.4 Commissioning

Programming the physical address and application program

Project design and commissioning of the device using ETS3 (from Version 3.0d), ETS4 or ETS5.

The device must have been connected and ready for use.

If mounted: Remove the design ring.

An appropriate device must be created and configured in the ETS project.

- Switch on the bus voltage.
- Press the red programming button (4).
The red programming LED in the sensor window lights up. The device displays the programming status in this way.
- Program the physical address with the help of the ETS.
The programming LED goes out.
- Label device on the side with physical address.
- Load the application program into the device using the ETS.

2.5 Operation

Operating element on the device

Dismantling the design ring makes the programming button accessible.

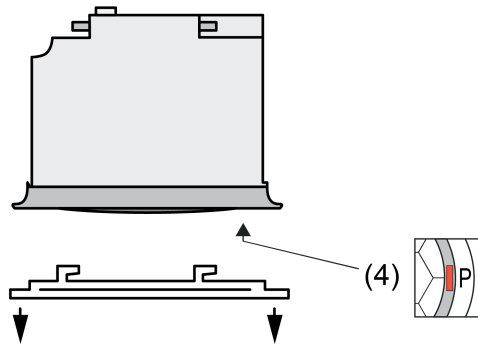

Figure 8: Programming button on the device

(4) Programming button (red)

3 Technical data

General

Protection class	III
Degree of protection	IP 44 (depending on installation)
Mark of approval	KNX/EIB
Ambient temperature	-25 ... +55 °C
Storage/transport temperature	-25 ... +70 °C
Relative humidity	10 ... 100 % (No moisture condensation)
Dimensions Ø×H	53.5 × 38 mm (with design ring)
Ceiling cut-out Ø×D	44 × 35 mm
Mounting position	horizontal

KNX supply

KNX medium	TP
Commissioning mode	S-mode
Rated voltage KNX	DC 21 ... 32 V SELV
Current consumption KNX	max. 10 mA
Connection, Bus	Connection terminal

Brightness sensor

Measuring range	10 ... 2000 lx
Accuracy (> 80 lx)	± 5%
Accuracy (≤ 80 lx)	± 10 lx
Resolution	1.9 lx

4 Software description

4.1 Software specification

ETS search paths: Phys. sensors / brightness / Brightness controller Mini
Configuration: S-mode standard
PEI type: "00"_{Hex} / "0"_{Dec}
PEI connector: no connector

Applications for brightness controllers:

No.	Short description	Name	Version	from mask version
1	Multifunction brightness controller application: Light control and brightness limiting values.	Brightness controller A01711	1.1 for ETS3.0 Version d onwards, ETS4 and ETS5	705

4.2 Software "Brightness controller A01711"

4.2.1 Scope of functions

- Brightness sensor for determining the workplace brightness or ambient brightness. Determination of the effective brightness of the workplace or floor surface by means of a reflection coefficient programmed at the factory. Adjustment of the reflection coefficient to other workplace or floor surfaces by calibration function if required.
- Evaluation of the measured brightness by up to three mutually independent brightness limiting values. If a limiting value configured in the ETS or predefined externally is exceeded or fallen below, the device can transmit switching, brightness value or scene recall telegrams to the bus.
- A complete and multi-functional light control can be implemented in the device. The light control makes it possible to keep the brightness level of an assigned lighting device constantly at a preset brightness setpoint even under changing external light influences (daylight and/or artificial light). Activation and deactivation of the light control by means of presence information. This presence information must be transmitted from another bus subscriber (e.g. another presence detector, motion detector or pushbutton) to the light control.
- The light control makes it possible to control up to three separate dimming channels and allows extensive adjustment of the brightness setpoint even during ongoing operation of the device (setpoint shift, external presetting, Teach). Startup control phase, control phase and step down control phase can be adjusted individually to the control requirement.

4.2.2 Notes on software

ETS project design and commissioning

For project design and commissioning of the device, ETS3.0d or more recent ETS version is required. We recommend using ETS4 from version 4.1.8 or ETS5.
No product database is available for ETS2 and older versions of ETS3.

Unloading the application program and non-executable application

After the application program has been unloaded by the ETS, the device has no function. The delivery state (see page 66) described can be restored by unloading with the ETS.

4.2.3 Object table

Number of communication objects: 35
 (max. object number 114 - gaps in between)

Number of addresses (max): 254

Number of assignments (max): 255



4.2.3.1 Objects for the sensor

Function:	Brightness sensor				
Object	Function	Name	Type	DPT	Flag
 ¹	Measured brightness value	Brightness sensor - Output	2 byte	9.004	C, -, T, R
Description	2-byte object that can transmit the brightness value of the room determined by the internal brightness sensor of the device to the bus. The device can transmit the brightness value actively and/or cyclically for a configured brightness change. It is also possible to only provide the brightness value passively and to transmit this on request (parameter-dependent).				

Function:	Brightness sensor				
Object	Function	Name	Type	DPT	Flag
 ²	Sensor calibration	Brightness sensor - Input	2 byte	9.004	C, W, -, -
Description	2-byte object that can supply an external brightness reference value to the device during the sensor calibration. During calibration, the device assigns the measured value specified via this object to the current, measured brightness value, whereby the measured value curve is adapted in the device.				

4.2.3.2 Objects for the light control

Objects of the output channels

Function: Output channels - activation of the KNX actuator					
Object	Function	Name	Type	DPT	Flag
 78	Switching	LC - Output channel 1	1-bit	1.001	C, -, T, -
Description: 1-bit object for switching activation of the KNX actuator of lighting channel 1. Its use depends on the configuration of the data formats of the control phases. This also makes combined activations possible by means of switching and dimming commands (objects 79, 80). It is recommended to link this object to the objects of the dimmable KNX actuator of channel 1 with the same function via a separate group address regardless of the control phase configuration. The application examples in this documentation show the necessary links of all communication objects.					
Function: Output channels - activation of the KNX actuator					
Object	Function	Name	Type	DPT	Flag
 79	Dimming	LC - Output channel 1	4-bit	3.007	C, -, T, -
Description: 4-bit object for activating the KNX actuator of lighting channel 1 via relative dimming commands. Its use depends on the configuration of the data formats of the control phases. This also makes combined activations possible by means of switching and dimming commands (objects 78, 80). It is recommended to link this object to the objects of the dimmable KNX actuator of channel 1 with the same function via a separate group address regardless of the control phase configuration. The application examples in this documentation show the necessary links of all communication objects.					
Function: Output channels - activation of the KNX actuator					
Object	Function	Name	Type	DPT	Flag
 80	Brightness value	LC - Output channel 1	1 byte	5.001	C, -, T, -
Description: 1-bit object for activating the KNX actuator of lighting channel 1 via absolute dimming values. Its use depends on the configuration of the data formats of the control phases. This also makes combined activations possible by means of switching and dimming commands (objects 78, 79). It is recommended to link this object to the objects of the dimmable KNX actuator of channel 1 with the same function via a separate group address regardless of the control phase configuration. The application examples in this documentation show the necessary links of all communication objects.					

Function: Output channels - activation of the KNX actuator

Object	Function	Name	Type	DPT	Flag
 81	Switching	LC - Output channel 2	1-bit	1.001	C, -, T, -

Description 1-bit object for switching activation of the KNX actuator of lighting channel 2. Its use depends on the configuration of the data formats of the control phases. This also makes combined activations possible by means of switching and dimming commands (object 82). It is recommended to link this object to the objects of the dimmable KNX actuator of channel 2 with the same function via a separate group address regardless of the control phase configuration. The application examples in this documentation show the necessary links of all communication objects.
This object is only visible if channel 2 is used.

Function: Output channels - activation of the KNX actuator

Object	Function	Name	Type	DPT	Flag
 82	Brightness value	LC - Output channel 2	1 byte	5.001	C, -, T, -

Description 1-bit object for activating the KNX actuator of lighting channel 2 via absolute dimming values. Its use depends on the configuration of the data formats of the control phases. This also makes combined activations possible by means of switching and dimming commands (object 81). It is recommended to link this object to the objects of the dimmable KNX actuator of channel 2 with the same function via a separate group address regardless of the control phase configuration. The application examples in this documentation show the necessary links of all communication objects.
To ensure that the superimposed operation works correctly in multichannel operation, the brightness value-feedback of an actuator must lead from channel 2 to this object whereby it is always essential to additionally set the "write" flag!
This object is only visible if channel 2 is used.

Function: Output channels - activation of the KNX actuator

Object	Function	Name	Type	DPT	Flag
 83	Switching	LC - Output channel 3	1-bit	1.001	C, -, T, -

Description 1-bit object for switching activation of the KNX actuator of lighting channel 3. Its use depends on the configuration of the data formats of the control phases. This also makes combined activations possible by means of switching and dimming commands (object 84). It is recommended to link this object to the objects of the dimmable KNX actuator of channel 3 with the same function via a separate group address regardless of the control phase configuration. The application examples in this documentation show the necessary links of all communication objects.
This object is only visible if channel 3 is used.

Function: Output channels - activation of the KNX actuator

Object	Function	Name	Type	DPT	Flag
 84	Brightness value	LC - Output channel 3	1 byte	5.001	C, -, T, -

Description 1-bit object for activating the KNX actuator of lighting channel 3 via absolute dimming values. Its use depends on the configuration of the data formats of the control phases. This also makes combined activations possible by means of switching and dimming commands (object 83). It is recommended to link this object to the objects of the dimmable KNX actuator of channel 3 with the same function via a separate group address regardless of the control phase configuration. The application examples in this documentation show the necessary links of all communication objects.
To ensure that the superimposed operation works correctly in multichannel operation, the brightness value-feedback of an actuator must lead from channel 3 to this object whereby it is always essential to additionally set the "write" flag!
This object is only visible if channel 3 is used.

Function: Output channel - Feedback of the KNX actuator

Object	Function	Name	Type	DPT	Flag
 85	Feedback brightness value	LC - Input channel 1	1 byte	5.001	C, W, T, A

Description 1-byte object via which the light control receives the current brightness value of the KNX actuator from channel 1. This information is important for some control processes. In the configuration, the light control must be informed as to how the actuator performs the feedback. This can take place by active, or alternatively, passive transmission (is then requested by this object). This object must always be linked to the brightness value feedback object of an activated KNX actuator from channel 1!
The basic regulation (control output calculation) always relates to channel 1. The control outputs of channels 2 and 3 are always calculated in relation to the control output of the first channel via corresponding offset settings. For this reason, only this one feedback object from channel 1 is necessary.

Objects for the setpoint

Function: Setpoint

Object	Function	Name	Type	DPT	Flag
 86	Setpoint preset	LC - Input	2 byte	9.004	C, W, -, -

Description 2-byte object for setting a basic setpoint. The setpoint received via this object remains unchanged until a new setpoint presetting (by means of external setpoint presetting, setpoint shift or Teach) or until a new reset command to the object "Setpoint Reset". Even a bus voltage failure will not reset the brightness setpoint received via the bus.
This object is only visible if the external setpoint presetting is enabled.

Function: Setpoint

Object	Function	Name	Type	DPT	Flag
 87	Setpoint Shift	LC - Input	4-bit	3.007	C, W, -, -

Description 4-bit object for relative shift of the active setpoint. With the setpoint shift the setpoint can be changed within the configured limits during the control phase by direct control of the assigned lighting.
 The setpoint shift is started by transmitting relative 4-bit dimming telegrams to the object "setpoint shift" during the control phase. At the same time, the light control controls the lighting via the relative dimming object of the first channel and thereby sets another brightness value. When the desired brightness is reached, a stop telegram must be received via the object "setpoint shift" which is then transmitted to channel 1 and output to the lighting.
 This object is only visible if the setpoint shift is enabled.

Function: Setpoint

Object	Function	Name	Type	DPT	Flag
 88	Reset setpoint	LC - Input	1-bit	1.015	C, W, -, -

Description 1-bit object for resetting the setpoint to the ETS presetting ("1" = reset setpoint, "0" = no reaction). It makes no difference which function changed the setpoint.

Function: Setpoint

Object	Function	Name	Type	DPT	Flag
 89	Setpoint Teach	LC - Input	1-bit	1.017	C, W, -, -

Description 1-bit object for triggering a Teach operation for learning a setpoint. With the Teach function, the effective brightness value is applied instantly by transmitting a corresponding telegram to this object as a new setpoint. The telegram polarity can be configured.
 This object is only visible if the Teach function for the setpoint presetting is enabled.

Function: Setpoint

Object	Function	Name	Type	DPT	Flag
 90	Setpoint effective	LC - Feedback - Output	2 byte	9.004	C, -, (T), (R)

Description 2-byte object for the feedback of the active setpoint of the light control. This object can optionally act as an active signalling object or passive status object (read out object). As an active signalling object, the current setpoint is transmitted once to the bus on each change of the setpoint, after ETS programming or after bus voltage return (optionally delayed).
 This object is only visible if the setpoint presetting is enabled.

Objects for disabling function and for superimposed operation

Function: Disabling function

Object	Function	Name	Type	DPT	Flag
 ⁹¹	Disabling	LC - Input	1-bit	1.003	C, W, -, -

Description: 1-bit object for activation and deactivation of the disabling function (telegram polarity configurable).

Function: Superimposed operation

Object	Function	Name	Type	DPT	Flag
 ⁹²	Switching	LC - Input / superimposed operation	1-bit	1.001	C, W, -, -

Description: 1-bit object for transmitting a superimposed operation in the data format "switching" to the light control. With the superimposed operation, the assigned lighting device can be activated directly, for example, via a pushbutton or operating panel. The manually triggered switching commands to the lighting also have to be transmitted to the lighting control via this object. By "listening in" to the telegrams, the light control is disabled during the superimposed operation, whereby the lighting is no longer influenced by the control but only by the user.
To make it possible to exit an application, the presence object or disabling object must be configured (parameter-dependent)!
This object is only visible if superimposed operation is enabled.

Function: Superimposed operation

Object	Function	Name	Type	DPT	Flag
 ⁹³	Dimming	LC - Input / superimposed operation	4-bit	3.007	C, W, -, -

Description: 4-bit object for transmitting a superimposed operation in the data format "dimming" to the light control. With the superimposed operation, the assigned lighting device can be activated directly, for example, via a pushbutton or operating panel. The manually triggered dimming commands to the lighting also have to be transmitted to the lighting control via this object. By "listening in" to the telegrams, the light control is disabled during the superimposed operation, whereby the lighting is no longer influenced by the control but only by the user.
To make it possible to exit an application, the presence object or disabling object must be configured (parameter-dependent)!
This object is only visible if superimposed operation is enabled.

 Function: Superimposed operation

Object	Function	Name	Type	DPT	Flag
 ⁹⁴	Brightness value	LC - Input / superimposed operation	1 byte	5.001	C, W, -, -

Description 1-byte object for transmitting a superimposed operation in the data format "brightness value" to the light control. With the superimposed operation, the assigned lighting device can be activated directly, for example, via a pushbutton or operating panel. The manually triggered brightness value commands to the lighting also have to be transmitted to the light control via this object. By "listening in" to the telegrams, the light control is disabled during the superimposed operation, whereby the lighting is no longer influenced by the control but only by the user.
To make it possible to exit an application, the presence object or disabling object must be configured (parameter-dependent)!
This object is only visible if superimposed operation is enabled.

 Function: Superimposed operation

Object	Function	Name	Type	DPT	Flag
 ⁹⁵	Scene extension	LC - Input / superimposed operation	1 byte	18.001	C, W, -, -

Description 1-byte object for transmitting a superimposed operation in the data format "scene recall" to the light control. With the superimposed operation, the assigned lighting device can be activated directly, for example, via a pushbutton or operating panel. The manually triggered scene recall commands to the lighting also have to be transmitted to the light control via this object. By "listening in" to the telegrams, the light control is disabled during the superimposed operation, whereby the lighting is no longer influenced by the control but only by the user.
To make it possible to exit an application, the presence object or disabling object must be configured (parameter-dependent)!
This object is only visible if superimposed operation is enabled.

 Function: Disabling status

Object	Function	Name	Type	DPT	Flag
 ⁹⁶	Status disabling fct light ctr	LC - Feedback - Output	1-bit	1.003	C, -, (T), (R)

Description 1-bit object for the feedback of the current disabling status of the light control. This object takes into account disabling operations of the light control by the disabling function or by a superimposed operation ("1" = light control disabled, "0" = light control in operation).
This object can optionally act as an active signalling object or passive status object (read out object). As an active signalling object, the current state is transmitted once to the bus on each change of the disabling state, after ETS programming or after bus voltage return (optionally delayed).
This object is only visible if the status function is enabled.

Object for the presence signal

Function: Presence control

Object	Function	Name	Type	DPT	Flag
 ⁹⁷	Presence	LC - Input	1-bit	1.010	C, W, -, -

Description 1-bit object for transmitting the presence information to the light control ("1" = presence exists, "0" = presence does not exist). The light control is activated (startup control phase) and deactivated (step down control phase) by means of the presence information.

4.2.3.3 Objects for the brightness limiting values

Objects for the output limiting values

Function:	Limiting value				
Object	Function	Name	Type	DPT	Flag
 ¹⁰²	Limit. value 1 switching	BLV - Output	1-bit	1.001	C, -, T, -
Description	1-bit object via which the first limiting value transmits the switching command if the limiting value thresholds are exceeded or not reached. This object is only visible if the function of the first limiting value is configured to "switching".				

Function:	Limiting value				
Object	Function	Name	Type	DPT	Flag
 ¹⁰²	Limit. value 1 brightness val.	BLV - Output	1 byte	5.001	C, -, T, -
Description	1-byte object via which the first limiting value transmits the brightness value command if the limiting value thresholds are exceeded or not reached. This object is only visible if the function of the first limiting value is configured to "brightness value".				

Function:	Limiting value				
Object	Function	Name	Type	DPT	Flag
 ¹⁰²	Limit. value 1 scene extension	BLV - Output	1 byte	18.001	C, -, T, -
Description	1-byte object via which the first limiting value transmits the scene recall command if the limiting value thresholds are exceeded or not reached. This object is only visible if the function of the first limiting value is configured to "scene extension".				

Function:	Limiting value				
Object	Function	Name	Type	DPT	Flag
 ¹⁰³	Limit. value 2 switching	BLV - Output	1-bit	1.001	C, -, T, -
Description	1-bit object via which the second limiting value transmits the switching command if the limiting value thresholds are exceeded or not reached. This object is only visible if the function of the second limiting value is configured to "switching". This object is only visible if the second limiting value is enabled.				

Function:	Limiting value				
Object	Function	Name	Type	DPT	Flag
 ¹⁰³	Limit. value 2 brightness val.	BLV - Output	1 byte	5.001	C, -, T, -
Description	<p>1-byte object via which the second limiting value transmits the brightness value command if the limiting value thresholds are exceeded or not reached. This object is only visible if the function of the second limiting value is configured to "brightness value".</p> <p>This object is only visible if the second limiting value is enabled.</p>				

Function:	Limiting value				
Object	Function	Name	Type	DPT	Flag
 ¹⁰³	Limit. value 2 scene extension	BLV - Output	1 byte	18.001	C, -, T, -
Description	<p>1-byte object via which the second limiting value transmits the scene recall command if the limiting value thresholds are exceeded or not reached. This object is only visible if the function of the second limiting value is configured to "scene extension".</p> <p>This object is only visible if the second limiting value is enabled.</p>				

Function:	Limiting value				
Object	Function	Name	Type	DPT	Flag
 ¹⁰⁴	Limit. value 3 switching	BLV - Output	1-bit	1.001	C, -, T, -
Description	<p>1-bit object via which the third limiting value transmits the switching command if the limiting value thresholds are exceeded or not reached. This object is only visible if the function of the third limiting value is configured to "switching".</p> <p>This object is only visible if the third limiting value is enabled.</p>				

Function:	Limiting value				
Object	Function	Name	Type	DPT	Flag
 ¹⁰⁴	Limit. value 3 brightness val.	BLV - Output	1 byte	5.001	C, -, T, -
Description	<p>1-byte object via which the third limiting value transmits the brightness value command if the limiting value thresholds are exceeded or not reached. This object is only visible if the function of the third limiting value is configured to "brightness value".</p> <p>This object is only visible if the third limiting value is enabled.</p>				

Function:		Limiting value				
Object	Function	Name	Type	DPT	Flag	
 104	Limit. value 3 scene extension	BLV - Output	1 byte	18.001	C, -, T, -	
Description	1-byte object via which the third limiting value transmits the scene recall command if the limiting value thresholds are exceeded or not reached. This object is only visible if the function of the third limiting value is configured to "scene extension". This object is only visible if the third limiting value is enabled.					

Objects for supplementary functions of the limiting values

Function:		Limiting value external presetting				
Object	Function	Name	Type	DPT	Flag	
 105, 108, 111	Limiting value x external presetting (x = 1, 2, 3)	BLV - Input	2 byte	9.004	C, W, -, -	
Description	2-byte object for presetting an external limiting value (10...2,000 Lux). The relative hysteresis value configured in the ETS results in a new value for both brightness thresholds depending on the type of limiting value definition. The new limiting value remains unchanged until a new presetting (externally via object or via Teach function). This object is only visible if the limiting value presetting is enabled.					

Function:		Limiting value Teach				
Object	Function	Name	Type	DPT	Flag	
 106, 109, 112	Limiting value x Teach (x = 1, 2, 3)	BLV - Input	1-bit	1.017	C, W, -, -	
Description	1-bit object for triggering a Teach operation for learning a limiting value. With the Teach function, the effective brightness value is applied instantly by transmitting a corresponding telegram to this object as a new limiting value. The telegram polarity can be configured. This object is only visible if the Teach function is enabled.					

Function:		Limiting value feedback				
Object	Function	Name	Type	DPT	Flag	
 107, 110, 113	Limiting value x effective (x = 1, 2, 3)	BLV - Feedback - Output	2 byte	9.004	C, -, (T), (R)	
Description	2-byte object for the feedback of an active limiting value. This object can optionally act as an active signalling object or passive status object (read out object). As an active signalling object, the current limiting value is transmitted once to the bus on each change of the limiting value, after ETS programming or after bus voltage return (optionally delayed). This object is only visible if the feedback is enabled.					

Objects for the disabling function

Function: Disabling function

Object	Function	Name	Type	DPT	Flag
 ¹¹⁴	Disabling	BLV - Input	1-bit	1.003	C, W, -, -

Description 1-bit object for activation and deactivation of the disabling function (telegram polarity configurable).
This object is only visible if the disabling function is enabled.

4.2.4 Functional description

4.2.4.1 Brightness sensor

Brightness measurement

To determine the workplace brightness or ambient brightness, the device possesses a brightness sensor, located behind the lens. The sensor detects the reflected mixed light composed of artificial light and daylight from the area or objects below the device. A reflection coefficient programmed at the factory enables the device to determine the effective brightness of the workplace surface or floor surface. The reflection coefficient of the device can be adapted to other workplace or floor surfaces by using the calibration function if required.

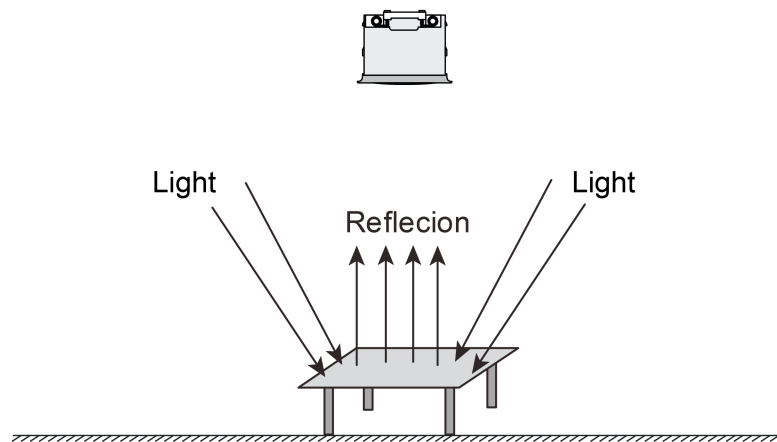

Figure 9: Brightness determination by measuring reflected mixed light composed of artificial light and daylight

The brightness value determined by the device can be made available to the KNX system via the 2 byte-communication object "Measured brightness value". The device can transmit the brightness value actively and/or cyclically for a configured brightness change. It is also possible to only provide the brightness value passively and to transmit this on request.

Calibration function

The value for the brightness to be determined on the work surface or floor surface by the device depends on the measured brightness. This is derived from the reflected brightness on the underlying surface. To determine the brightness on the measuring surface from the measured brightness on the device, the reflection coefficient of the surface must be known. In the factory calibration, the reflection coefficient for the measuring surface is set to 0.3. This already makes an adjustment to many surfaces possible.

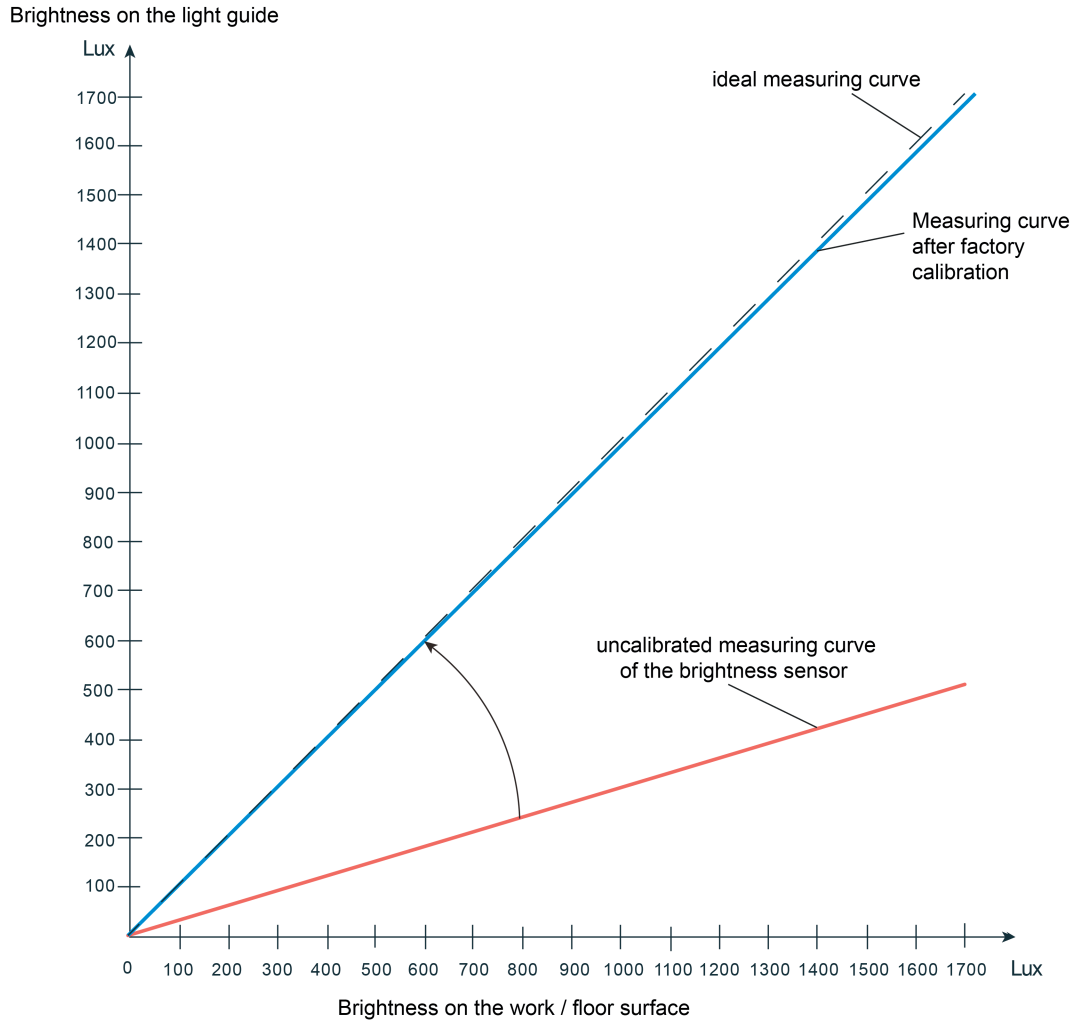

Figure 10: Determining the brightness on the work / floor surface during factory calibration
 Reflection coefficient 0.3 corresponds to surface finish (grey desktop)

To compensate for any deviations between the brightness determined during factory calibration and the real brightness on the work surface, the brightness measurement can be calibrated using a calibration function (adjustment of the reflection coefficient) and thus adapted to special surface finishes. During calibration, an externally preset brightness value at the workplace is assigned to the currently measured brightness. This presetting is made via the 2-byte communication object "sensor calibration". The sensor calibration in the ETS must be activated on the parameter page "Light sensor" by the parameter of the same name so that this object can be visible and subsequent calibration possible. For this purpose, this parameter must be set from "factory calibration" to "calibration by telegram".

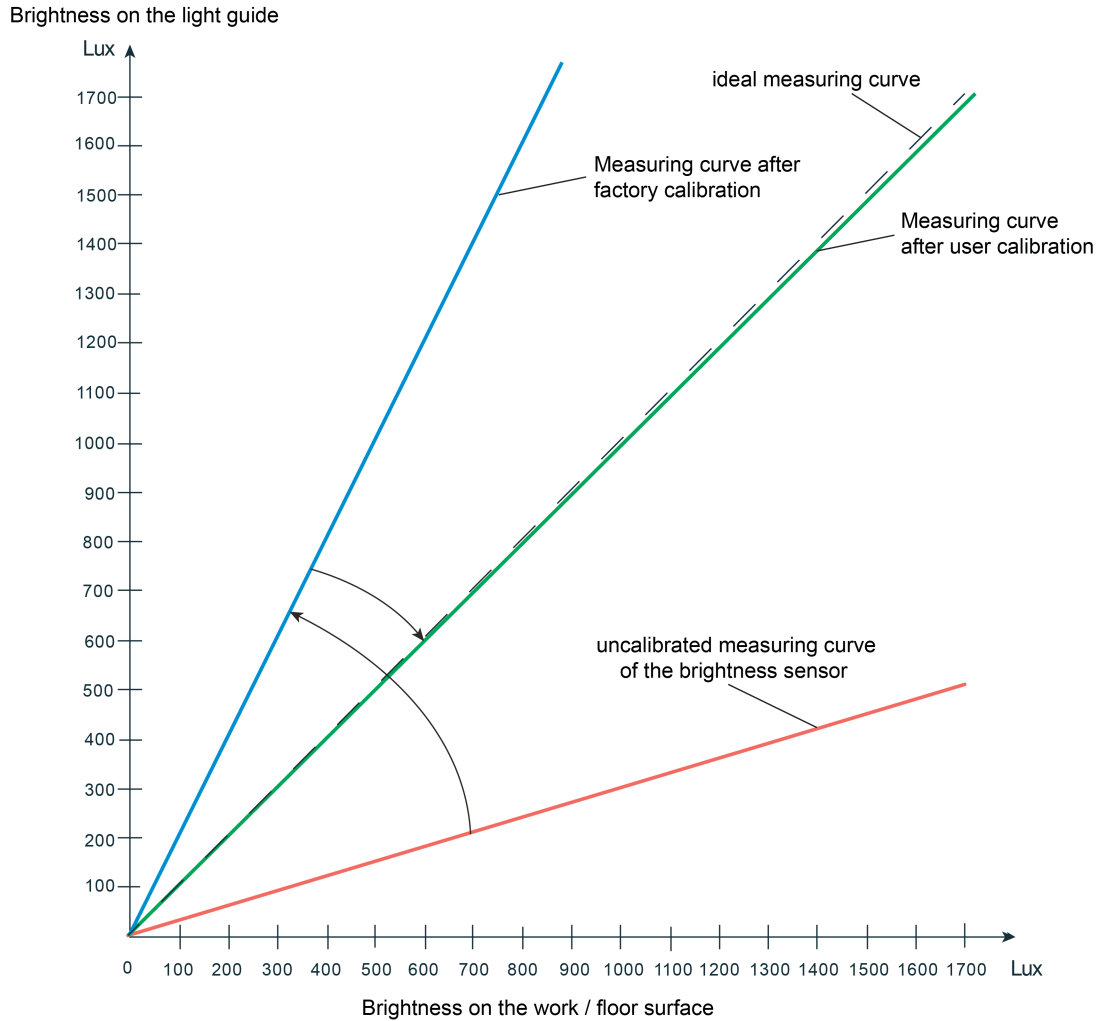

Figure 11: Correction of the determined brightness on the work / floor surface by means of user calibration
e.g. reflection coefficient 0.5 corresponds to surface finish (light floor covering)

Whether or not a subsequent user calibration is necessary can be determined purely subjectively or by reference measurement. A user calibration should be performed if the light control can be evaluated subjectively as "not adequate" by persons present. Alternatively, it is possible to determine whether subsequent calibration is necessary immediately after commissioning by reading out the brightness value determined by the device during factory calibration via the object "Measured brightness value". Here, the read out brightness value must be compared with the measured value of a suitable brightness meter (calibrated luxmeter) located on the work surface or floor surface. If the deviation between the brightness values is too great, a user calibration should be performed. During the comparison measurement on the surface, several measurements should be made at various points. The individual measurement results must then be averaged and compared with the measured value of the device. Since the reflection coefficient set by the factory calibration is correct in most cases, a user calibration is not necessary.

- i A user calibration is necessary if an unfavourable mounting location has been chosen for the device or the device measures the reflected light of a dark floor surface.

The following steps must be carried out for a user calibration...

- Set the brightness level in the room as desired.

- Then transmit the brightness on the work / floor surface (measuring surface) that was measured several times and averaged - with the aid of the ETS, for example - to the object "sensor calibration". As a result, the device assigns the predefined measured value to the currently measured brightness value, whereby the measured value curve is adapted in the device.

If the parameter "sensor calibration" in the ETS is set to "calibration by telegram", the device will not evaluate any brightness until a user calibration has been carried out! In this case, the light control will therefore have no function until a calibration has been carried out properly. The brightness value tracked via the object "Measured brightness value" can be influenced by the parameter "Behaviour in case calibration not carried out" in the event of a calibration not yet carried out. Depending on the setting, the device will either transmit no brightness value (value "0" in the object) or the value "7FFF" (hexadecimal) to indicate an invalid brightness measured value.

-  An old user calibration is replaced permanently by a new calibration (is preserved even after bus voltage failure). The sensor calibration can be reset to factory calibration at any time by the parameter in the ETS.

4.2.4.2 Light control

4.2.4.2.1 Application basics

A complete and multi-functional light control can be implemented in the device. The light control makes it possible to keep the brightness level of an assigned lighting device constantly at a preset brightness setpoint even under changing external light influences (daylight and/or artificial light). The light control is activated and deactivated by means of presence information. This presence information must be transmitted from another bus subscriber (e.g. another presence detector, motion detector or pushbutton) to the light control.

The light control makes it possible to control up to three separate dimming channels and allows extensive adjustment of the brightness setpoint even during ongoing operation of the device (setpoint shift, external presetting, Teach). Startup control phase, control phase and step down control phase can be adjusted individually to the control requirement.

- i** The lighting control assumes that a dimmable lighting system is activated (KNX actuator comprising e.g. dimmer actuators, DALI-Gateways, 1-10V control units). The light control cannot be used for only switchable lighting systems. In these cases, the device function "Brightness limit values" is a sensible alternative. This allows the implementation of switching light control.

Control operation

The entire control operation of the controller is always divided into four states/phases executed in succession...

- Phase 1: State OFF (basic state)
In the OFF state, no presence signal is present (presence = 0, no motion detected) and the controlled artificial light is switched off.
- Phase 2: Start up control state
As soon as a presence signal (presence = 1) is received in the OFF state, the controller changes to the startup control state. The presence information must be received via the object "Presence". In the startup control state, the currently measured brightness is first compared with the preset setpoint, and depending on this, the following steps are then taken:
Brightness value < setpoint: The configured behaviour (telegram output) for switching on the lighting is executed. After a configured waiting time, the state changes to control.
Brightness value >= setpoint: The state changes immediately to control without switching on the lighting.
- Phase 3: Control state
In the Control state, the controller tries to compensate light fluctuations (due to daylight and/or extraneous light) by dimming the connected lighting up and down so that the measured brightness value is within the hysteresis range of the setpoint as constantly as possible. In the course of this, it is also possible to switch off the lighting completely within the control phase if there is sufficient basic brightness. The lighting can be dimmed up and down with relative (4-bit) or absolute (1-byte) dimming commands (control outputs) depending on configuration. Once a presence signal is no longer present (presence = 0), the controller changes to the step down state.
- Phase 4: Step down control state
In the step down control state, the controller can optionally switch off the lighting directly or first dim it down to a brightness and then switch it off after a configurable additional waiting time. Once the lighting has been switched off or the waiting time has elapsed, the controller changes to the OFF state.

The process of a possible control operation is shown in the figure below.

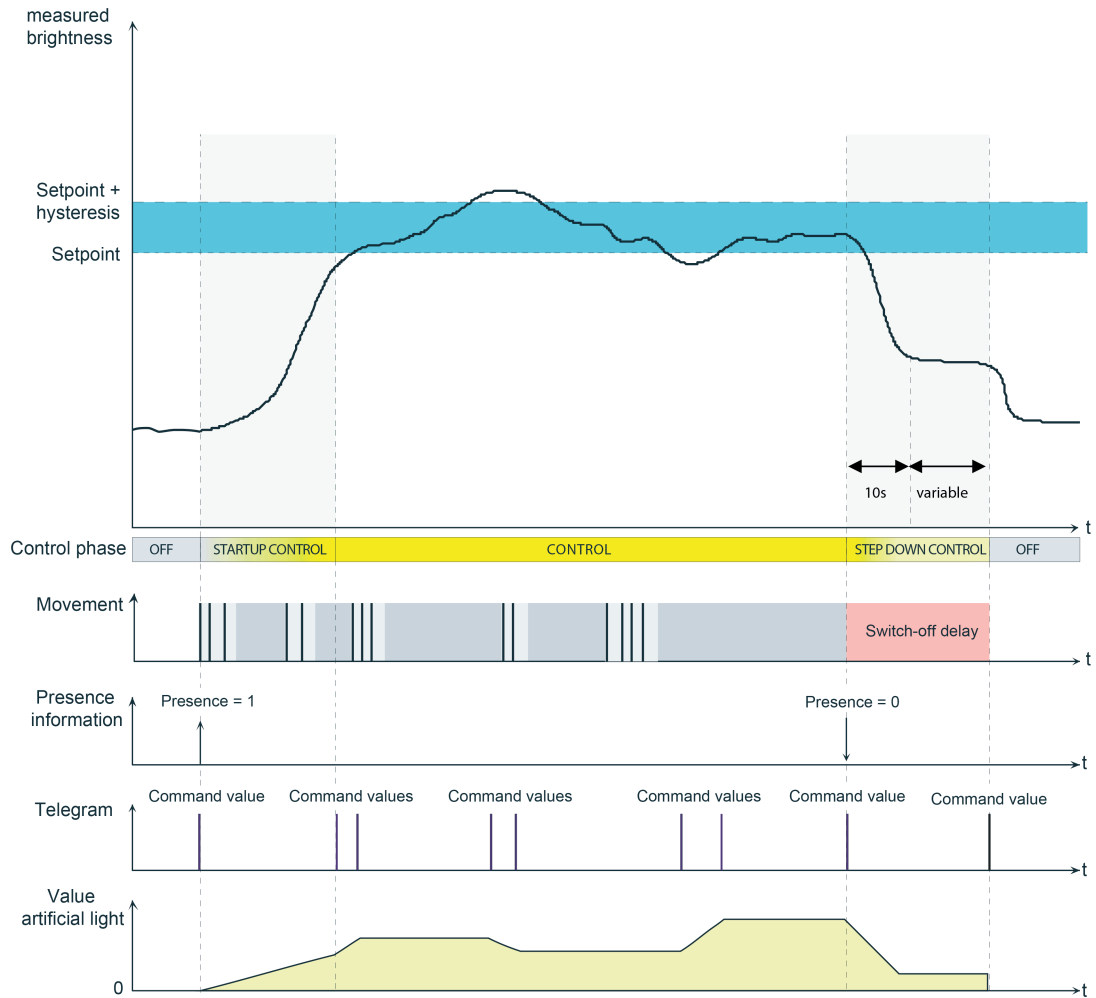

Figure 12: Example of a control process with all control phases

- i The exact behaviour of the individual control phases can be adapted by an appropriate configuration (setpoint presetting and control strategy).

4.2.4.2.2 Operation of the light control

Light control is always operated autonomously on the brightness controller. When the function "light control" is enabled on the parameter page of the same name, it can be used. Light control is activated and deactivated by an external presence detection via the object "Presence" (e.g. from an external presence detector, pushbutton or similar device).

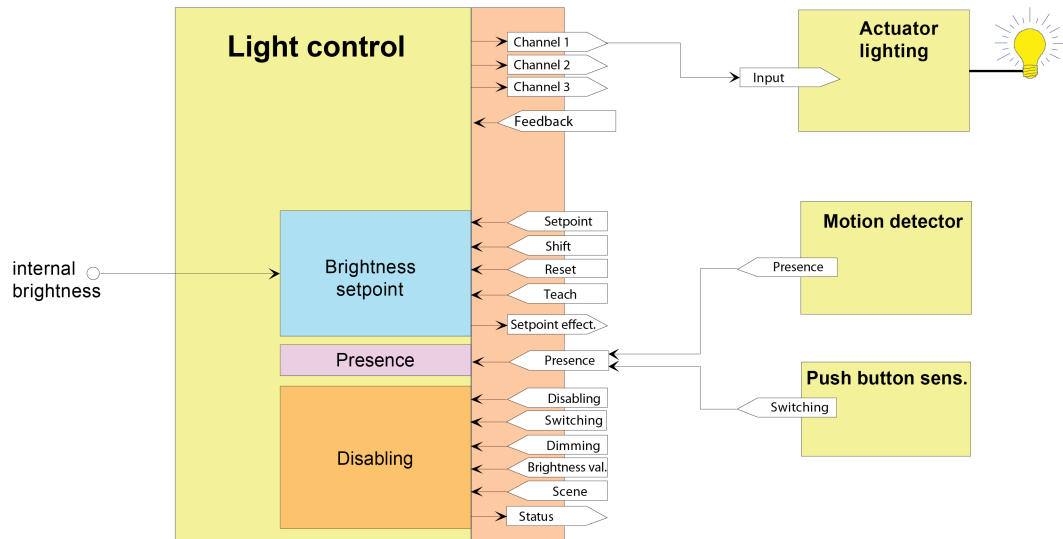

Figure 13: Application example for light control

4.2.4.2.3 Brightness setpoint

Introduction

The brightness setpoint corresponds to the value of the desired brightness that the light control is to set and keep as constant as possible with the aid of an assigned lighting device while taking changing external light influences into account. In order to avoid permanent readjustment of the connected lighting device due to slight brightness and measurement value fluctuations, a setpoint range with a lower and upper limiting value is defined for the setpoint presetting (Figure 14).

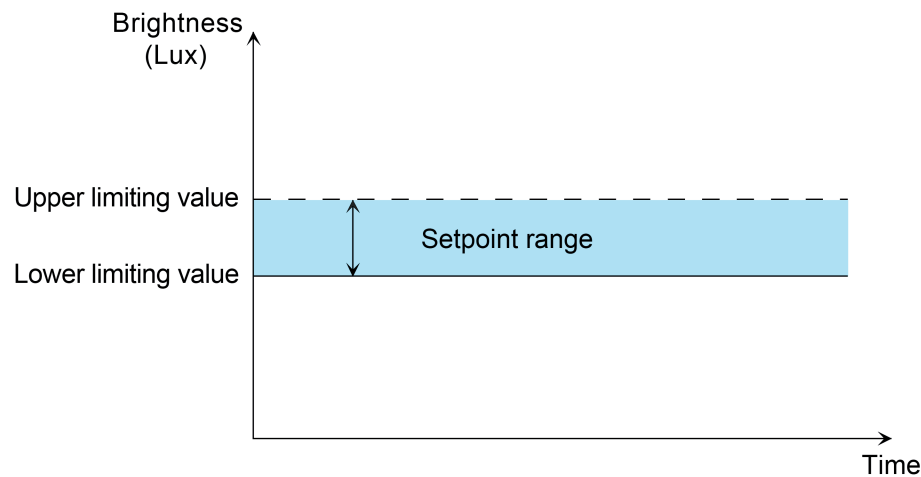

Figure 14: Setpoint range of the light control

During the control phase, the lighting is only readjusted if the measured brightness value is not within the preset setpoint range. The lower limiting value of the setpoint range is preset directly by the "setpoint". The "setpoint" thus represents the minimum brightness to be maintained. The upper limiting value is determined by the presetting of a relative hysteresis value (percentage) in relation to the setpoint.

Example:

Setpoint = 400 Lux, hysteresis value = 20 %

-> Setpoint range: lower limiting value = 400 Lux, upper limiting value = 480 Lux

In addition to the basic presetting of the setpoint by the parameter "setpoint" in the ETS, this can also be changed by an external setpoint presetting or by the Teach function and thus adapted to user requirements. If the setpoint is changed, the value of the upper limit of the setpoint range is also recalculated automatically by the device. The size of the setpoint range changes accordingly as a result of the relative hysteresis value (Figure 15).

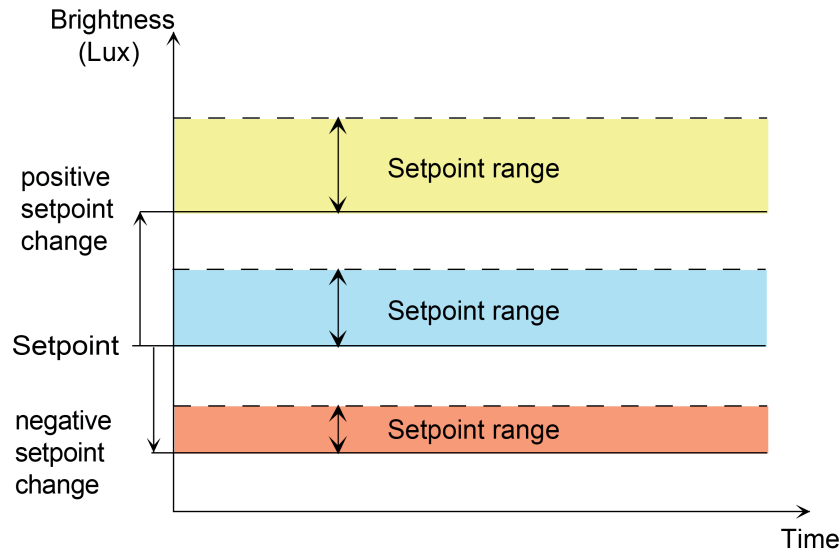

Figure 15: Shift of the setpoint range by means of setpoint adjustment

The object "setpoint effective" can be used for the feedback of the setpoint set effectively in the light control (lower limit of setpoint range). This object contains the active setpoint of the light control and can either transmit the value actively on change, or make it available passively. As an active signalling object, the current value is transmitted once automatically to the bus on each change of the setpoint, after ETS programming or after bus voltage return (optionally delayed).

- i** The possible adjustment range of the parameter "setpoint" depends on the configuration of the control dynamic in the ETS. In a standard control dynamic, the setpoint can be configured within the range from 20 Lux to 1,000 Lux (from 50 Lux in 50-Lux increments). As a result, virtually all standard applications are covered. In user-defined control dynamic, the setpoint in the ETS is continuously configurable within a range from 10 Lux to 2,000 Lux. This allows extended setpoint presettings for special applications.

External setpoint presetting

The currently set brightness setpoint can be reset in accordance with DPT 9.004 by transmitting a 2-byte brightness value to the object "Preset setpoint". This object is configurable if the parameter "object 'Setpoint presetting'" is set to "enabled" on the parameter page "LC - General". The setpoint received via the object remains unchanged until a new setpoint presetting (by means of external setpoint presetting, setpoint shift or Teach) or until a new reset command to the object "Setpoint Reset". Even a bus voltage failure will not reset the brightness setpoint received via the bus. ETS programming resets the setpoint automatically to the ETS presettings if this is provided for in the configuration (see below).

- i** The disabling function, the superimposed operation or current control status have no effect on the external setpoint presetting.

Setpoint shift

With the setpoint shift the setpoint can be changed within the configured limits during the control phase by direct control of the assigned lighting. The setpoint shift is started by transmitting relative 4-bit dimming telegrams to the object "setpoint shift" during the control phase. At the same time, the light control controls the lighting via the relative dimming object of the first channel and thereby sets another brightness value. When the desired brightness is reached, a stop telegram must be received via the object "setpoint shift" which is then transmitted to channel 1 and output to the lighting.

The new brightness set in this way is measured by the brightness sensor of the device after a delay time of approx. 2 seconds has elapsed and applied as a new setpoint. If no stop telegram is received after the last dimming telegram of the setpoint shift, the device transmits a stop telegram automatically to the lighting via channel 1 after 30 seconds. After a further 2 seconds, the determined brightness value is then saved as a new setpoint.

In the ETS, limiting values of the setpoint shift can be configured. If a configured limiting value is exceeded during the setpoint shift, the setpoint shift stops automatically after detecting that the limiting value has been exceeded. The device then transmits a stop telegram to the bus via channel 1. The corresponding limiting value is then applied as new setpoint value instead of the set brightness value.

With the parameter "Validity of the setpoint shift" it is possible to define in the ETS whether a setpoint shift should only apply temporarily for the control phase currently active, or alternatively, should be applied permanently. If the setpoint shift is applied permanently, the set setpoint remains unchanged until a new setpoint presetting (by means of external setpoint presetting, setpoint shift or Teach) or until a new reset command via the object "Setpoint Reset". Even a bus voltage failure will not reset the brightness setpoint value. ETS programming resets the setpoint automatically to the ETS presettings if this is provided for in the configuration (see below).

- i** If the lighting channels 2 or 3 are also in use (Figure 16) during the light control, the 4-bit dimming objects of the dimmer actuators activated via these channels must be connected to the object "Output channel 1 dimming" of the light control (same group address as dimmer actuator in channel 1).

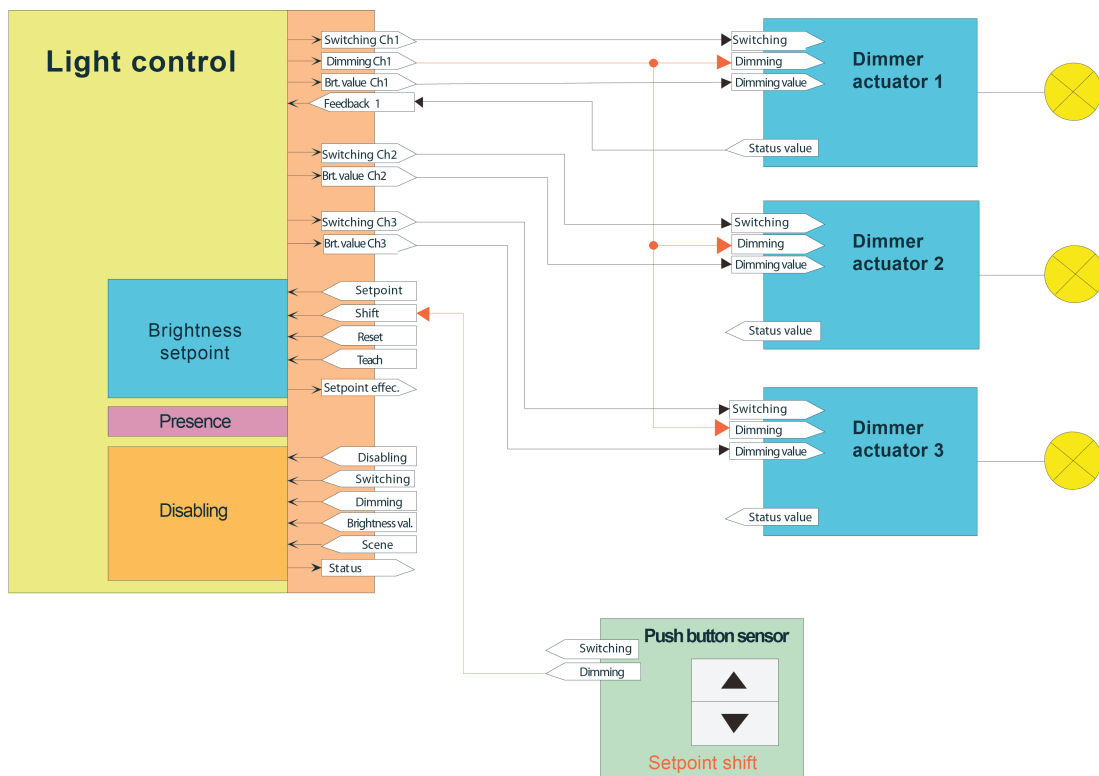

Figure 16: Application example for the setpoint shift with 3 lighting channels

Teach function

The Teach function is another possibility for the external presetting of the brightness setpoint. With the Teach function, the currently measured brightness value is applied instantly by transmitting a corresponding telegram to the 1-bit object "Setpoint Teach" as a new brightness

setpoint. This object is configurable if the parameter "Teach function" is set to "enabled" on the parameter page "LC - General".

The polarity of a Teach telegram is configurable by the parameter "Teach operating mode". Depending on the configuration, it is possible to reset to the configured setpoint upon receiving the opposite object value (Teach inactive). The setpoint previously learned will be lost in the process. If, however, the Teach operating mode is configured to "1"- and "0"-active, it is not possible anymore to reset to the configured setpoint via this object during ongoing operation of the device! The new setpoint set with the teach function remains unchanged until a new setpoint presetting (by means of external setpoint presetting, setpoint shift or a by a new Teach) or by a new reset command to the object "Setpoint Reset". Even a bus voltage failure will not reset the new brightness setpoint value. ETS programming resets the setpoint automatically to the ETS presettings if this is provided for in the configuration (see below).

- i** The disabling function, the superimposed operation or current control status have no effect on the Teach function.

Setpoint Reset

The currently set brightness setpoint can always be reset to the value configured in the ETS via the 1-bit object "Setpoint Reset". It makes no difference which function changed the setpoint.

- i** The disabling function, the superimposed operation or current control status have no effect on the setpoint reset.

Setpoint presetting with ETS programming

The parameter "Overwrite setpoint in device for ETS-download?" determines whether an actively set and active setpoint by previous external object presetting or by Teach is overwritten automatically by the setpoint configured in the ETS during ETS programming. If the setting is "yes", the last value preset externally or by Teach and still active is replaced by the ETS presetting. If the setting is "no", the last setpoint preset externally or by Teach still remains active even after ETS programming.

- i** If the parameter "Overwrite setpoint in device for ETS-download?" is set to "no" and no external presetting has been made yet - if provided for in the configuration - via the 2-byte object or by Teach after the first ETS commissioning, the device always works with the value configured in the ETS. The ETS parameter only becomes invalid within the above configuration after an external presetting or after a Teach.

4.2.4.2.4 Channel configuration

The light control can control up to three lighting groups. Up to 3 output channels are available for this purpose. It is possible to adapt control outputs for various installation locations of the lighting groups in the room by using several channels, for example. Thus, a lighting group near the window, for example, can be controlled by small control outputs as lighting in the centre of the room. These with less control outputs, used in turn as lighting in a remote recess.

The number of channels can be defined via the parameter "Number of lighting channels to be controlled" on the parameter page "LC - General". If several channels are used, the control output of the feedback control in the startup and main control phase only takes place with absolute 1-byte dimming values. The basic regulation (control output calculation) always relates to channel 1. The control outputs of channels 2 and 3 are always calculated in relation to the control output of the first channel via corresponding offset settings. Three methods are available for calculating the control outputs of channel 2 and 3. The parameter "Offset behaviour" defines which method is used.

Method 1: Fixed offset with increasing control output

If this method is chosen, a fixed offset value is selected for channels 2 and 3 for the output control of the first channel. The offset remain constant across the entire control output range.

The offset calculation always starts from the control output "1" of channel 1. For the control output "0" (OFF), the control outputs of channel 2 and 3 are also set to "0".

To prevent channels 2 and 3 from being switched too frequently in the case of negative offset in the threshold range, an ON-OFF hysteresis can be configured in relation to the control outputs of channel 1. The ON-OFF hysteresis should be less than the offset value for channel 1.

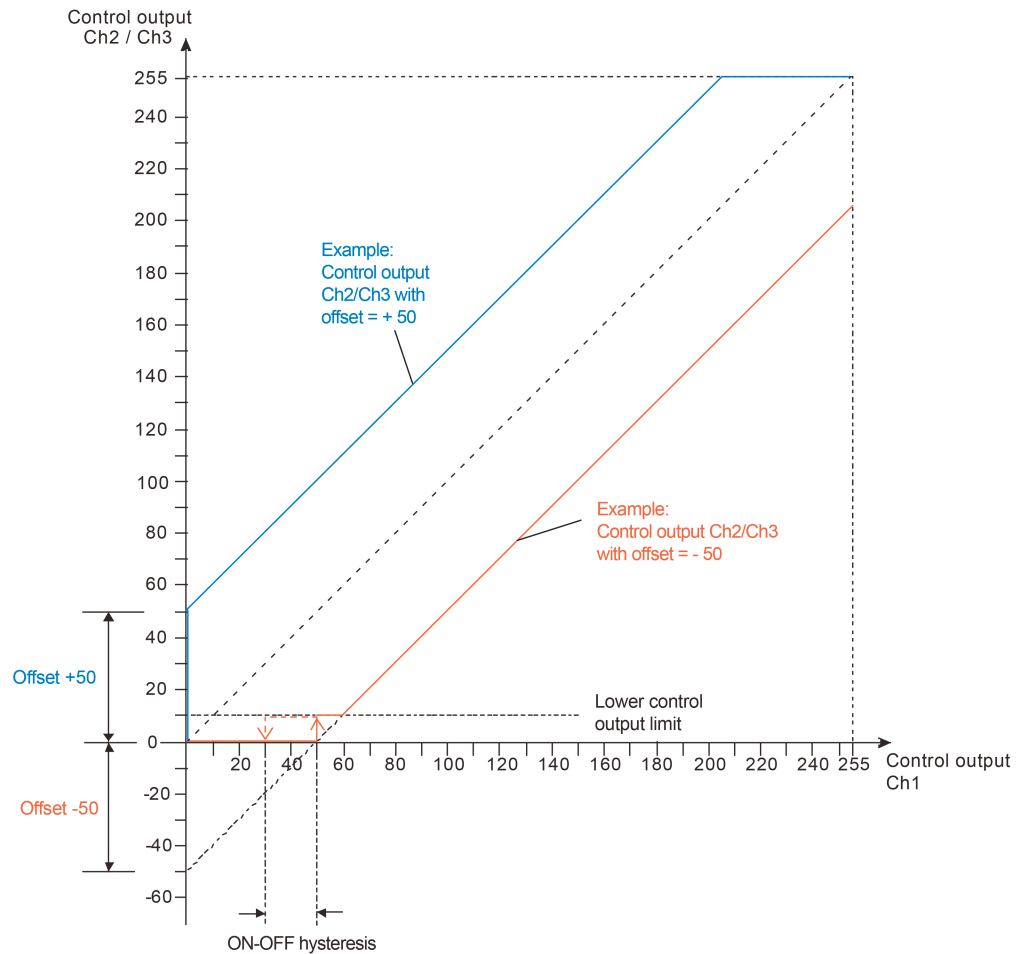

Figure 17: Control outputs of channels 2 or 3 dependent on the control output of channel 1
Method 1: Fixed offset with increasing control output

Example:

Channel configuration: Channel 1 and 2
 Offset behaviour: Offset fixed with increasing control output
 Offset channel 2 to channel 1: -50
 Lower control output limit: 10 (see main control phase)
 ON-OFF hysteresis: 20

Command value channel 1: 128 (50%) -> Command value channel 2: 78 (30%)
 Command value channel 1: 20 (8%) -> Command value channel 2: 0 (0%)

Method 2: Offset increasing with increasing control output

With this method, the offset value is increased for channel 2 or 3 with increasing control outputs of channel 1. This takes place until channel 2 or 3 has reached the limiting value 255. The offset settings for the control outputs of channel 2 and 3 are specified in percentage relative to the control output of channel 1. Offset settings less than 100 % result in a negative offset value and offset settings greater than 100 % result in a positive offset value for the control output of the first channel.

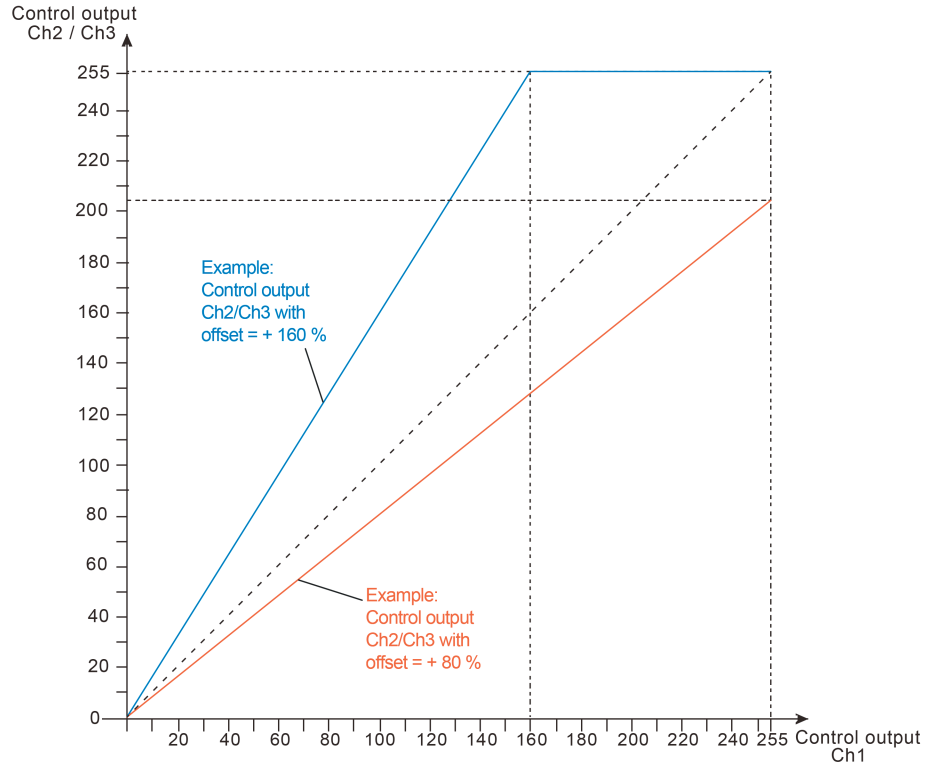

Figure 18: Control outputs of channels 2 or 3 dependent on the control output of channel 1
Method 2: Offset increasing with increasing control output

Example:

Channel configuration: Channel 1, 2 and 3

Offset behaviour: Offset increasing with increasing control output

Offset channel 2 to channel 1: 160 %

Offset channel 3 to channel 1: 80 %

Command value channel 1: 128 (50%) -> Command value channel 2: 204 (80%), Command value channel 3: 102 (40%)

Command value channel 1: 20 (8%) -> Command value channel 2: 32 (12%), Command value channel 3: 16 (6%)

Method 3: Offset decreasing with increasing control output

With this setting, the offset value for channel 2 or 3 is reduced continuously from the start offset with increasing control outputs of the first channel until a limiting control output of channel 1.

The offset for channels 2 and 3 is always "0" from the limiting control output of channel 1 which results in a synchronization of the output channels. The offset calculation always starts from the control output "1" of channel 1. For the control output "0" (OFF), the control outputs of channel 2 and 3 are also set to "0". To configure this offset setting, a start offset for channels 2 and 3 and the control output from channel 1 for the synchronization must be preset.

To prevent channels 2 and 3 from being switched too frequently in the case of negative offset in the threshold range, an ON-OFF hysteresis can be configured in relation to the control outputs of channel 1. The ON-OFF hysteresis must be adjusted appropriately to the start offset.

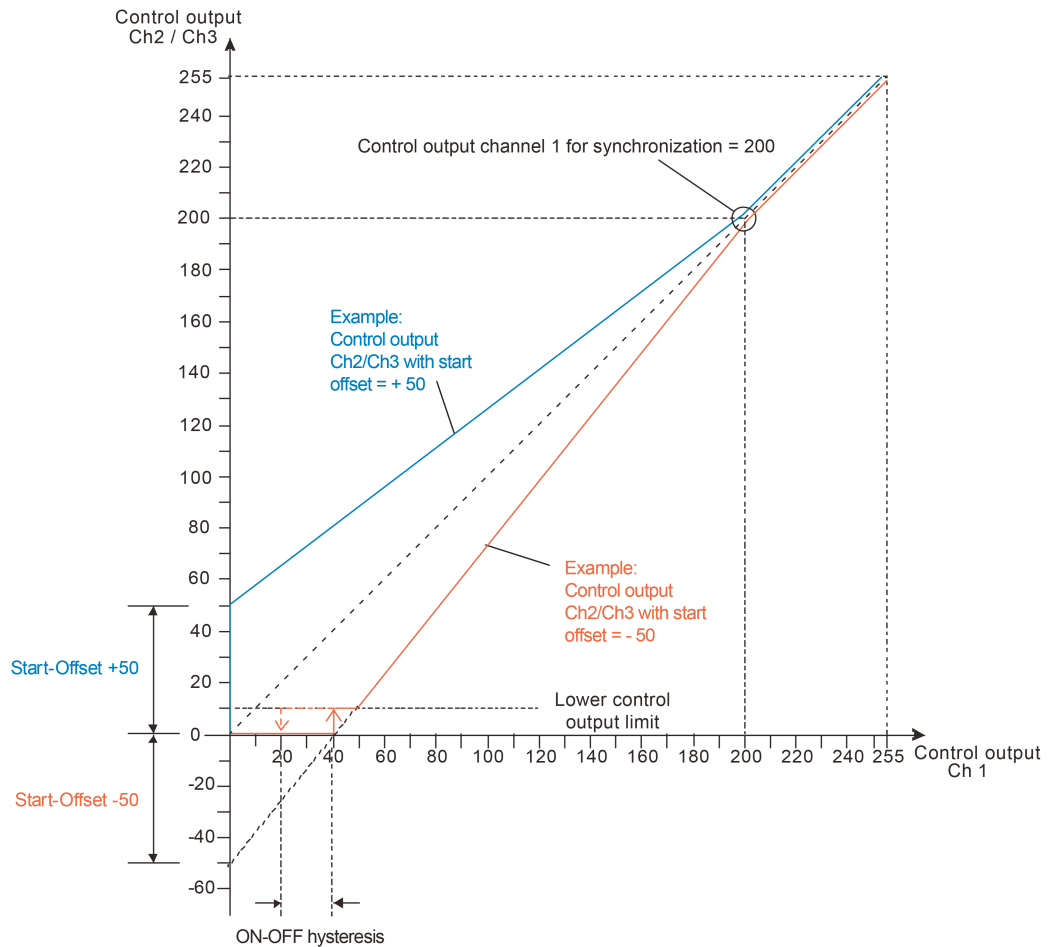

Figure 19: Control outputs of channels 2 or 3 dependent on the control output of channel 1
Method 3: Offset decreasing with increasing control output

Example:

Channel configuration: Channel 1, 2 and 3

Offset behaviour: Offset decreasing with increasing control output

Start offset channel 2 to channel 1: +50

Start offset channel 3 to channel 1: -50

Control output from channel 1 for synchronization to channel 2: 200

Control output from channel 1 for synchronization to channel 3: 200

Lower control output limit: 10 (see main control phase)

ON-OFF hysteresis: 20

Command value channel 1: 180 (70%) -> Command value channel 2: 185 (72%), Command value channel 3: 175 (68%)

Command value channel 1: 60 (23%) -> Command value channel 2: 95 (12%), Command value channel 3: 25 (6%)

4.2.4.2.5 Control behaviour

Startup control phase

The start up control phase represents the start behaviour of the light control and should quickly ensure sufficient brightness in the room. For this purpose, the brightness value setpoint is compared with the measured brightness value at the beginning of the startup control phase. If the measured value is greater or equal to the setpoint, the main control state is changed to immediately. If the measured value is below the setpoint, the configured startup control behaviour is executed. At the same time, there are the following settings in the ETS...

- Startup control behaviour = "Switching on"
If the currently determined brightness value is less than the preset setpoint, the light control switches on the assigned lighting via a switching telegram (1-bit). The lighting is activated by the channel object "Switching".

i This setting is only available if just one output channel is configured.

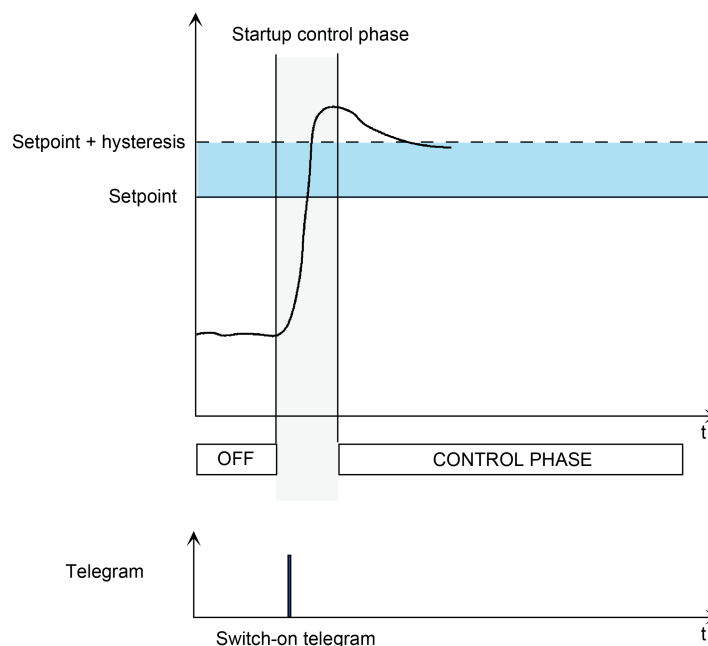

Figure 20: Startup control behaviour with switching telegram (1-bit)

- Startup control behaviour = "control output presetting (relative dimming)"
If the currently determined brightness value is less than the preset setpoint, the light control dims up the lighting via cyclically output dimming step telegrams until the brightness value has reached or even exceeded the setpoint. The increment of the dimming telegrams and the time for the telegram repetition are configurable (optional). After reaching or exceeding the setpoint limit, a stop telegram is transmitted. In the case of dimmer actuators with steep dimming curves, slight overshooting may occur that is then offset again by the main control phase.

The lighting is activated by the channel object "Switching".

i This setting is only available if just one output channel is configured.

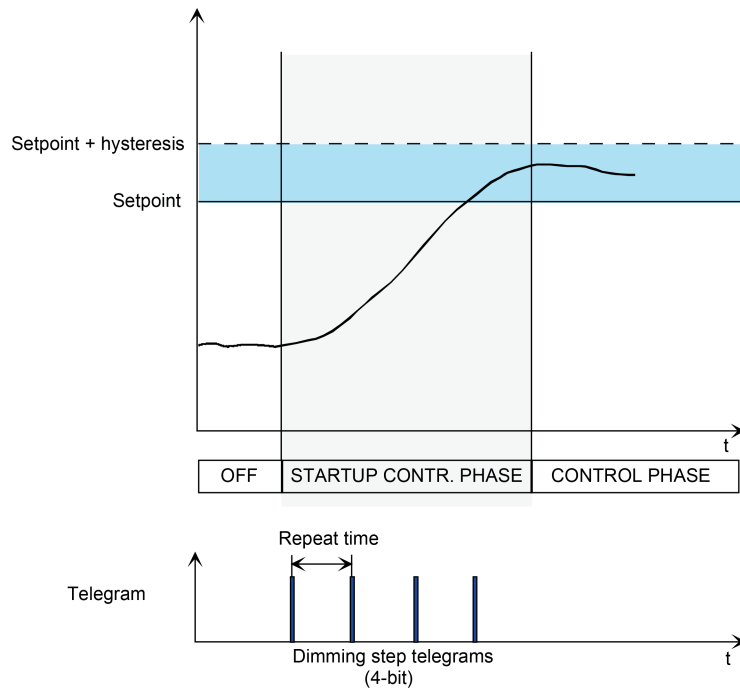

Figure 21: Startup control behaviour with relative dimming step telegrams (4-bit)

- Startup control behaviour = "control output presetting (brightness value)"
 If the light control detects a lower brightness value than the preset setpoint, the lighting is then switched on by transmission of a configured dimming value. If a higher brightness value is preset (e.g. 100 %), this results in a brightness jump (like when switching on), which is then offset again by the main control phase if the higher brightness value is not required.
 The lighting is activated by the channel object "brightness value".

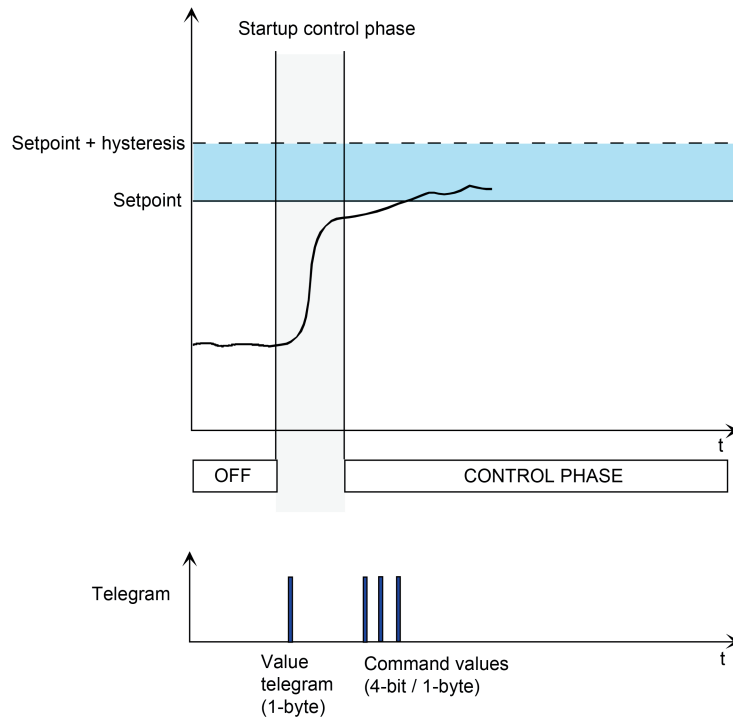

Figure 22: Startup control behaviour with absolute value telegrams (1-byte)

- Startup control behaviour = "control output adaptive (brightness value)"
 With this startup control behaviour, depending on the currently measured brightness by the light control, a control output (1-byte) is calculated and transmitted automatically by means of the setpoint presetting and defined brightness range in order to approximately reach the exact setpoint range.
 The lighting is activated by the channel object "brightness value".

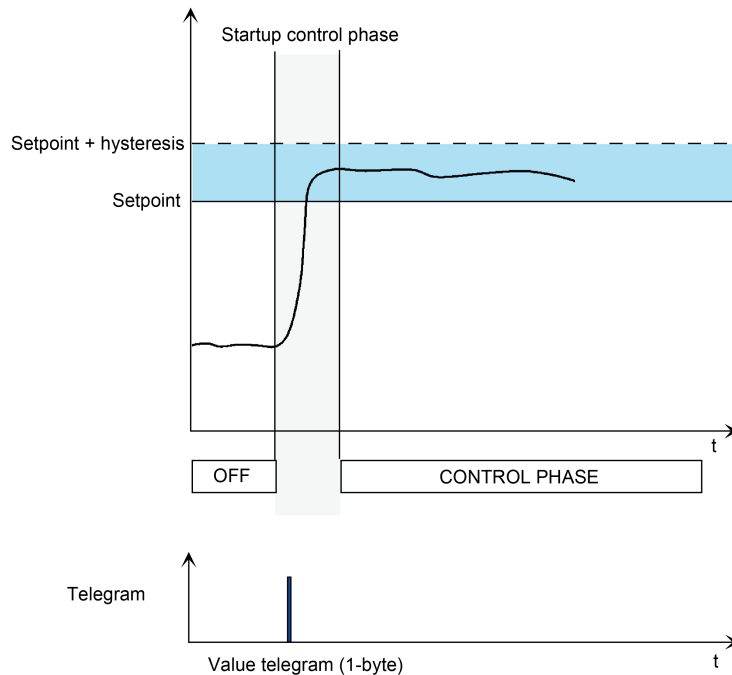

Figure 23: Startup control behaviour with adaptive control output presetting (1-byte)

Waiting time after start up control

Before changing from the start up control phase to the main control phase, the activated actuator should have reached its final value so that the feedback control can control with stable actuator states. For this purpose, a configurable waiting time is started after the startup control phase. The main control phase is only changed to after this waiting time has elapsed. The length of the waiting time should be adapted to the startup control method used (e.g. longer waiting time with relative startup control behaviour) and the characteristics of the connected actuator (fast or slow dimming speed).

Main control phase

In the main control phase, the light control adjusts the brightness of the lighting continuously to the active setpoint. At the same time, the data format used of the control outputs is configurable by the ETS parameter "control behaviour". Alternatively, the lighting can be activated by absolute brightness value telegrams (channel object "brightness value") or by relative dimming step telegrams (channel object "dimming"). The parameters "minimum dimming step width" (in the case of relative control output presetting) and "minimum control output change per dimming step" (in the case of absolute control output presetting) define in which steps the light control can dim the lighting by one telegram each. The parameter "minimum repeat time for control outputs" specifies for the light control how long the minimum waiting time must be between two control output telegrams.

Small dimming steps (relative 1...3% / absolute 2...10) with short repeat times (2...10 seconds) should normally be specified so that the light control is executed interruption-free and is subjectively pleasant. Since the dimming speed is primarily defined by the configuration of the actuator, the parameter of the light control should therefore be adapted to the dimming times of the actuators.

Lower control output limit and switch-off brightness

When switching off the lighting in the room using the light control, it should be ensured that the lighting is not switched on again immediately by falling below the setpoint due to the light jump.

For this purpose, the lower control output limit can be evaluated and a switch-off brightness can be configured.

After reaching the lower control output limit, the switch-off brightness in the room must also be reached or exceeded so that the lighting is switched off automatically during the main control phase. The switch-off brightness is above the setpoint + hysteresis. The switch-off brightness is derived from an additional relative hysteresis value that is added to the hysteresis value of the setpoint: Switch-off brightness = setpoint + (setpoint x (hysteresis setpoint + additional hysteresis switch-off brightness))

The additional hysteresis for the switch-off brightness is configured separately in the ETS.

Example:

Setpoint = 300 Lux, hysteresis setpoint = 10 %,

Additional hysteresis switch-off brightness = 10 %

-> Upper setpoint limit = 330 Lux, switch-off brightness = 360 Lux

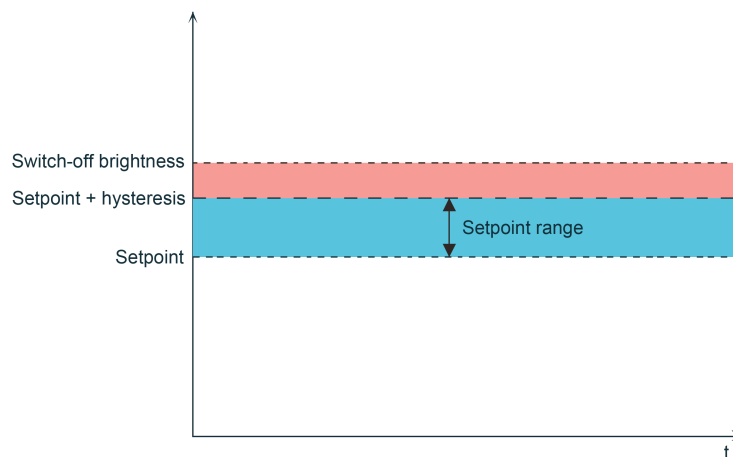

Figure 24: The switch-off brightness results relatively from the setpoint and hysteresis value of the setpoint

The light control only evaluates the lower control output limit if the parameter "influence behaviour in case of lower control output limit?" is set to "Yes". In this case, the "behaviour if lower control output limit is fallen below" is configurable as follows...

- Setting "Switch off at switch-off brightness"
As soon as the lower control output limit is reached and the switch-off brightness in the room has also been reached or exceeded, the light control switches off the lighting. The additional hysteresis for the switch-off brightness can only be configured in this setting.
- Setting "no reaction"
Once the lower control output limit is reached, the light control no longer reacts. A switch-off does not take place. The control output remains unchanged until the control has to dim up the lighting again or until the step down control phase is started due to the presence signal.

i In the case of an absolute control output presetting, the lower control output limit is defined by the parameter of the same name within the range of 1...128 (0.4%...50%). In the case of relative control output presetting, the lower control output limit cannot be configured. In this configuration, the device calculates rather the lower control output limit itself by means of the configured minimum dimming step width. The relative dimming step telegrams transmitted to the actuator then enable the light control to detect during the ongoing control process whether or not the lower control output limit has been reached. It is important that the activated KNX dimmer actuators can be dimmed to the lowest brightness level (basic brightness). The dimmable brightness range must not be limited by a minimum brightness on the actuators!

If the parameter "influence behaviour in case of lower control output limit?" is configured to "No", the light control never responds once the lower control output limit is reached. Here too, the control output remains unchanged until the control has to dim up the lighting again or until the step down control phase is started due to the presence signal.

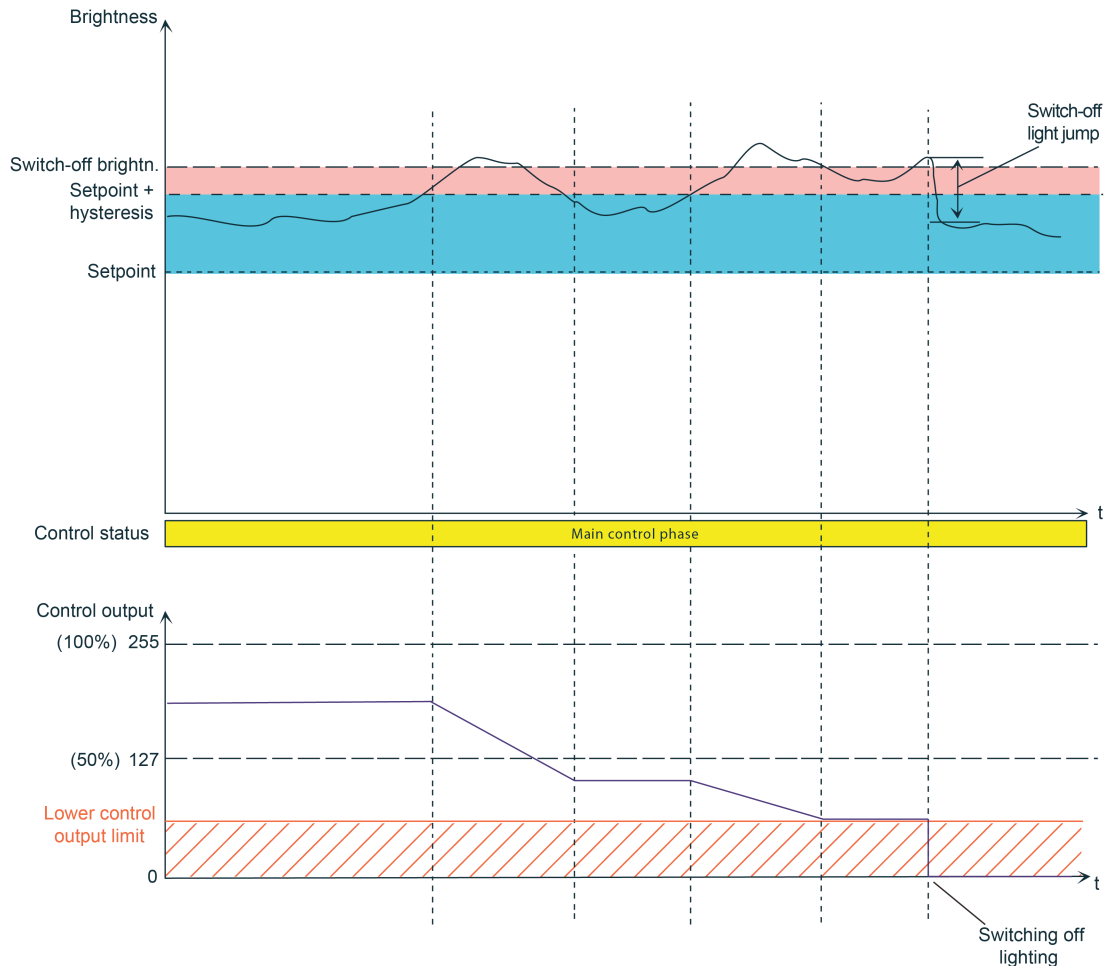

Figure 25: Example of a control output presetting with evaluation of the lower control output limit

The relative setting of the additional hysteresis for the switch-off brightness also influences the interval of the switch-off brightness for the upper setpoint limit during a setpoint shift (Figure 26).

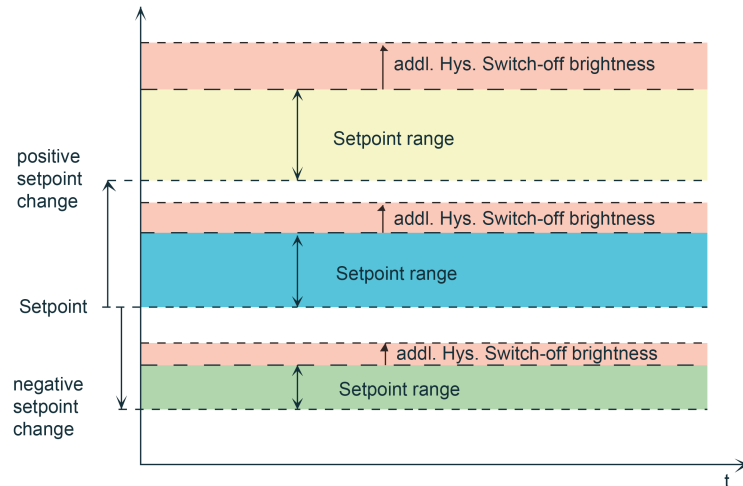

Figure 26: Dependency of the additional hysteresis for the switch-off brightness during a setpoint shift

Step down control phase

The behaviour at the end of the control is determined in the step down control phase. Here, - defined by the parameter "Behaviour at the beginning of the step down control phase - the assigned lighting device can optionally be switched off immediately, or first dimmed down to minimum brightness by transmitting the minimum control output. As a further alternative, it is possible for the device to transmit a configured control output (1...100 %). When transmitting the minimum control output, it is necessary to define with which data format this takes place. This defines the parameter "step down control behaviour" (value telegram "1" or dimming step telegram 100%).

When dimming down to minimum brightness or when dimming to the configured control output, a delay time is started at the beginning of the dimming process. The duration of the waiting time is derived from a standard waiting time (10 seconds) plus an additional waiting time that can be configured in the ETS. The standard waiting time ensures that the minimum or preset brightness also can actually be set by the activated dimmer actuators before the end of the step down process.

After the waiting time has elapsed, the parameter "Behaviour after waiting time has elapsed" decides which state the lighting adopts at the end of the control process. With the setting "switch off", the light control finally switches off the lighting. The parameter "switch off by" defines with which data format this takes place. As an alternative to switching off, the control output can also be kept constant. This setting is appropriate, for example, if a permanent basic brightness is to be set in the room (e.g. in long corridors or passageways).

During an ongoing waiting time in the step down control phase, a new presence can be transferred to the light control if, for example, people are present again in the room. In this case, the parameter "Behaviour on new presence detection during waiting time" defines how the light control should behave. The presence detection can either be ignored. The light control then executes the step down control phase interruption-free until the end as preset. If the presence signal is still present at the end of the step down control phase, the light control restarts the startup control phase.

Alternatively, the step down control phase can be cancelled immediately during the detection of a new presence and the startup control phase started at once interruption-free.

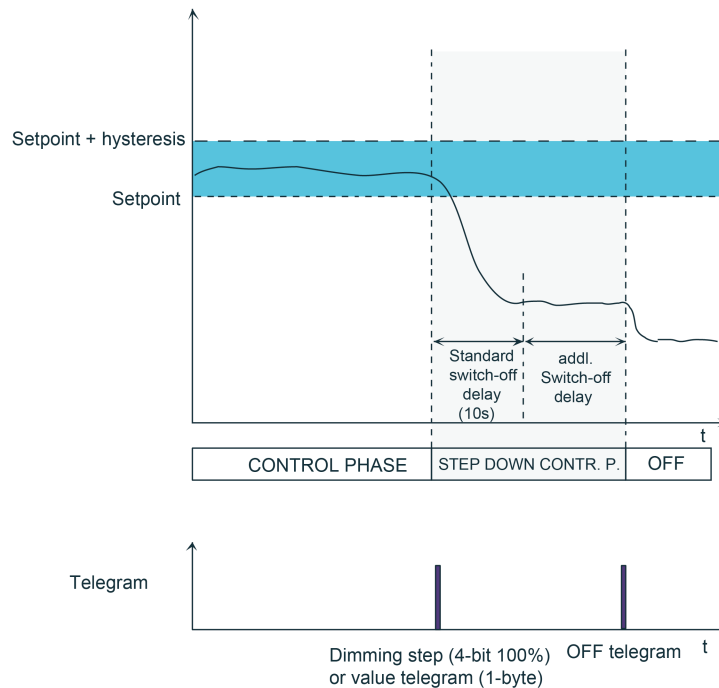

Figure 27: Step down control behaviour with waiting time

Definition of the brightness range

The light control needs certain parameters that define the brightness range in the room. These parameters are important for calculating certain control characteristics from which, among other things, the control dynamic and thus the subjective perceived comfort of the feedback control are derived. The required control parameters include, firstly, the information regarding which maximum illuminance can be set by the lighting in the room (artificial light). In the case of a large difference between the brightness in the room and the setpoint, this maximum value defines larger control output changes or increments and thus increases the control dynamic (fast adjustment to the setpoint by larger control output commands). The maximum illuminance is also used for calculating the control output for the adaptive start up control. This control parameter must be configured to the maximum brightness value adjustable by the lighting (P-component of the light control). The maximum value of the lighting is typically a factor of 1.2 higher than the setpoint configured in the ETS.

Secondly, the darkness value of the room lighting (lower brightness threshold) is decisive for the light control. If the lower brightness threshold is fallen below, the time between the control output telegrams is shortened thereby resulting in a higher control dynamic here as well.

The parameter "Adaptation of the control dynamic in the brightness range" defines whether the light control works with standard control parameters that Gira has predefined and generally adapted to many applications, or whether the control parameters can be customized...

- Setting "Standard":

The light control works with a standard configuration preset by Gira. The control dynamic is thus adapted effectively to very many applications. The maximum illuminance is then not configurable in the ETS. This is calculated automatically depending on the setpoint configured in the ETS (factor x 1.2) and entered in the light control. When dimensioning the lighting system on-site, it must be ensured that the installed lighting can always supply brightness levels that correspond to the value "configured setpoint x 1.2".

The lower brightness threshold is preconfigured to 0 Lux with this setting (no special control dynamic in the lower brightness range).

- Setting "user-defined":
With user-defined control dynamic the maximum illuminance (10...2,000 Lux) and lower brightness threshold (0...2,000 Lux) can be configured in the ETS. In this way, it is possible to customize the control parameters to special applications.
When configuring the control parameters, the following dependency should be noted:
Lower brightness threshold < Setpoint < Maximum illuminance.

- i The possible adjustment range of the parameter "setpoint" depends on the configuration of the control dynamic in the ETS. In a standard control dynamic, the setpoint can be configured within the range from 20 Lux to 1,000 Lux (from 50 Lux in 50-Lux increments). As a result, virtually all standard applications are covered. In user-defined control dynamic, the setpoint in the ETS is continuously configurable within a range from 10 Lux to 2,000 Lux. This allows extended setpoint presettings for special applications.

4.2.4.2.6 Disabling function

The light control can be disabled via the disabling function, meaning that it is deactivated. It can be brought to a defined state at the beginning or end of the disabling function.

The disabling function of the light control is activated via a separate disabling object. The disabling function can be activated by force after bus voltage return or after ETS programming.

Behaviour at the beginning of the disabling function

The parameter "Behaviour at the beginning of the disabling function" defines the behaviour of the light control if the disabling function is activated. The following settings are possible...

- "disable and send no telegram":
At the start of disabling, no telegrams are transmitted via the outputs. The assigned lighting is not influenced.
- "Disable and transmit telegram":
At the start of the disabling function, freely configurable switching or brightness value telegrams can be output via the output channels in order to set the assigned lighting to the desired state. The telegrams are configured in the ETS separately for each channel.
- "Execute disable and step down control behaviour":
With this setting, the configured step down control behaviour is executed on activation of the disabling function. Presence signals are ignored during execution of the step down control behaviour.

Behaviour at the end of the disabling function

On ending the disabling function, the light control is reset. The device then stops ongoing disabling reactions (e.g. step down control behaviour) immediately. The parameter "Behaviour at the end of the disabling function" defines the behaviour of the light control at the end of the disabling function. The following settings are possible here...

- "enable and send no telegram":
With this setting, the light control after enabling is internally in the state OFF and reacts to the newly received presence according to the configuration. The lighting state, which might have been changed externally during an active disabling function depending on the application, must be taken into account when enabling! At the end of the disabling function, the current existing lighting state will not be changed until new presence information by the light control. If control output presettings are made via absolute brightness values, the 1-byte object "Feedback brightness value" of the light control must be connected to an actuator feedback object of channel 1 so that the light control knows the output state of the lighting. Otherwise, the light control may be adversely affected thereby resulting in erratic control behaviour.
- "enable and switch off":
At the end of the disabling function, the assigned lighting is switched off via the switching outputs in order to restore a defined basic state of the lighting. If a presence exists or a new presence is received, the control is restarted according to the measured brightness.
- "execute enable and startup control behaviour":
With this setting, a presence signal is activated artificially at the end of the disabling function. As a result, the startup control behaviour is executed automatically at the appropriate brightness value (determined brightness < value setpoint). The main control phase is then changed to. The further behaviour of the control process is dependent on the actual presence information.

Optionally, the disabling status of the light control can be made available via the 1-bit object "Status disabling function light control". For this purpose, the parameter "Feedback 'Status disabling function light control'?" must be configured to "Yes" on the parameter page "LC - Disable / Superimposed operation". The light control - if the object was enabled - transmits its own disabling status depending on the parameter "Effect of the feedback" either actively to the

bus on each change, or it only provides the object value passively (object is readable).
The disabling status is influenced by the disabling function and by the superimposed operation.
A "1" indicates an active disabling function of the light control.

4.2.4.2.7 Superimposed operation

Superimposed operation

With the superimposed operation, the assigned lighting device can be activated directly, for example, via a pushbutton or operating panel. In addition, the manually triggered switching or dimming commands to the lighting also have to be transmitted to the lighting control. For this purpose, the light control has 4 objects each with different data formats ("Input superimposed operation" - 1-bit switching, 4-bit relative dimming, 1-byte brightness value, 1-byte scene extension). By "listening in" to the telegrams via the named objects, the light control is disabled during the superimposed operation, whereby the lighting is no longer influenced by the control but only by the user.

If the device detects a superimposed operation, the presence signal of the light control is then internally activated automatically (an active motion detection is simulated). Additionally, the evaluation of the presence information remains functional via the object of the light control, so that the presence signal can be tracked (optional for enabling after superimposed operation).

The behaviour of the light control at the end of the superimposed operation is defined by the parameter "enabling after superimposed operation". The following settings are possible...

- "automatic at the end of the presence":
With this setting, the control is enabled automatically at the end of the tracked presence detection and the step down control behaviour is executed. With this application, the end of the presence (deactivation of the presence information) must be received actively via the object "Presence" in order to end the superimposed operation and execute the step down control behaviour. In this case, the superimposed operation can be ended alternatively via the disabling object (see setting "only via disabling object").
- "only via disabling object":
With this setting, the disabling of the control after a superimposed operation can only be cancelled with an enabling telegram via the disabling object. With the enabling telegram the configured behaviour is executed at the end of the disabling function.

- i** To ensure that the superimposed operation works correctly in multichannel operation, the brightness value-feedbacks of the actuators must lead from channel 2 and 3 to the channel value objects of the light control (objects 82 and 84), whereby it is always essential to additionally set the "write" flags of these objects!
- i** Optionally, the disabling status of the light control can be made available via the 1-bit object "Status disabling function light control". For this purpose, the parameter "Feedback 'Status disabling function light control?'" must be configured to "Yes" on the parameter page "LC - Disable / Superimposed operation". The light control - if the object was enabled - transmits its own disabling status depending on the parameter "Effect of the feedback" either actively to the bus on each change, or it only provides the object value passively (object is readable).

The disabling status is influenced by the disabling function and by the superimposed operation. A "1" indicates an active disabling function of the light control.

4.2.4.2.8 Application examples

Two application examples are shown below, which illustrate the linking of all necessary communication objects between sensors, the device incl. light control and actuators.

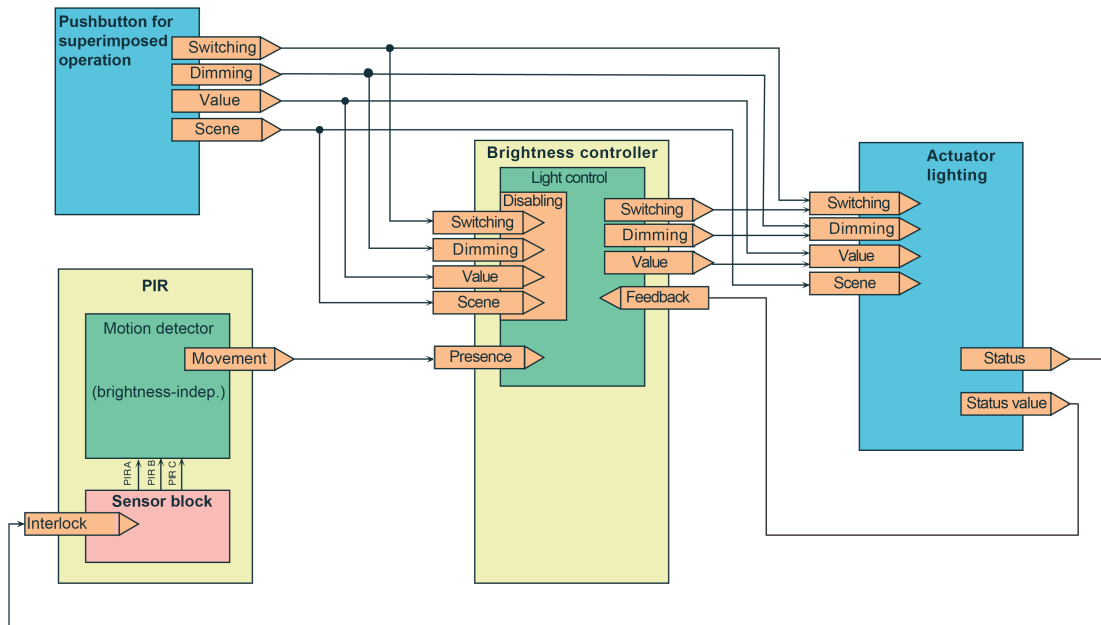

Figure 28: Application example 1
Light control with external presence detector and pushbutton sensors for superimposed operation and manual switch ON/OFF

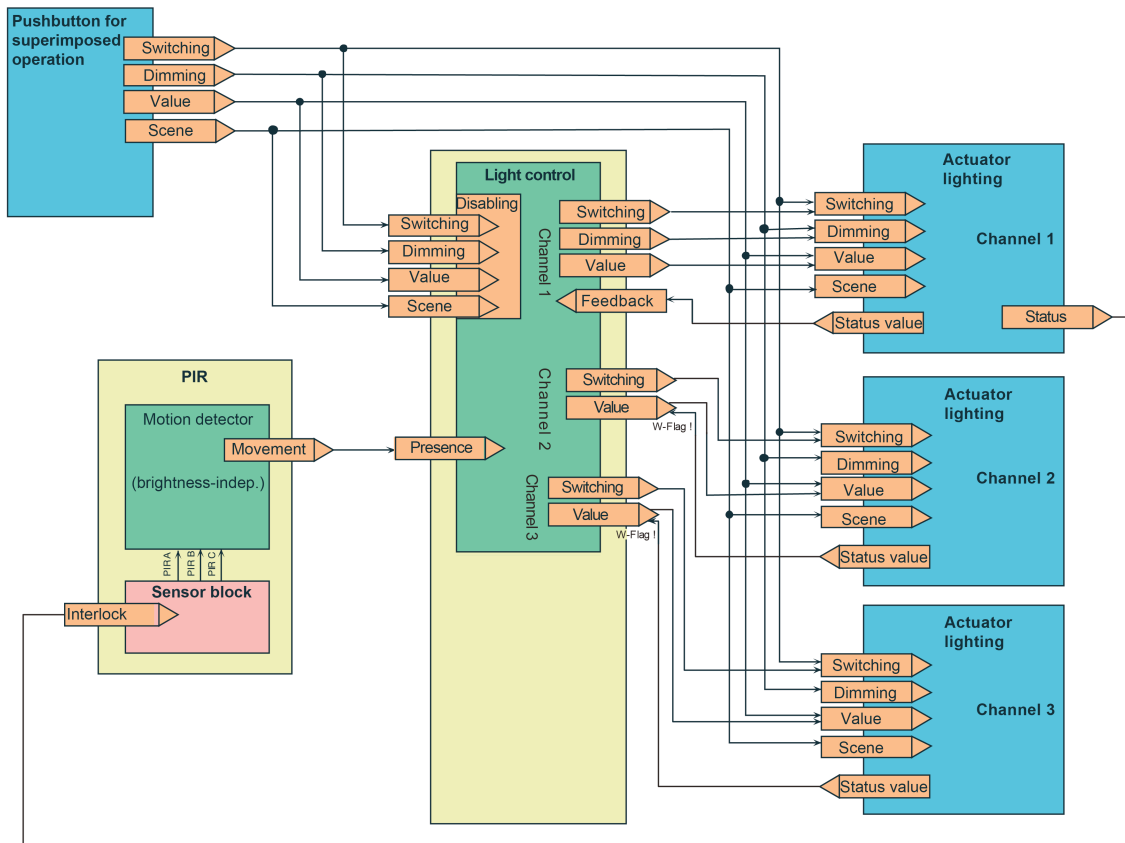

Figure 29: Application example 2
Light control with 3 lighting channels and with external presence detector and pushbutton for superimposed operation

4.2.4.2.9 Behaviour after a device reset

Behaviour after bus voltage return

The behaviour of the light control after bus voltage return is defined by the parameter "Behaviour after bus voltage return" on the parameter page "LC - General". The following settings are available...

- "No reaction"
With this configuration, the light control is in normal state after bus voltage return. It can be activated and operated regularly.
- "Activate disabling function"
With this setting, the light control is set to the disabling state after bus voltage return. The configured behaviour is executed at the beginning of the disabling function.
- "State of disable fct as before bus voltage failure"
With this setting, the disabling state of the light control is adopted as it was before bus voltage failure. If the disabling function should be activated, the configured behaviour is executed at the beginning of the disabling function.

Behaviour after ETS programming

The behaviour of the light control is also definable after ETS programming. The behaviour is defined by the parameter "Behaviour after ETS programming operation" on the parameter page "LC - General". The following settings are available...

- "No reaction"
With this configuration, the light control is in normal state after ETS programming. It can be activated and operated regularly.
- "Activate disabling function"
With this setting, the light control is set to the disabling state after ETS programming. The configured behaviour is executed at the beginning of the disabling function.

4.2.4.3 Brightness limiting values

The device has up to three mutually independent brightness limiting values that are continuously compared with the brightness value detected. If a limiting value configured in the ETS or predefined externally is exceeded or fallen below, the device can transmit switching, brightness value or scene recall telegrams to the bus and thus trigger appropriate reactions in other bus subscribers.

The "Function brightness limiting values" must be enabled in the ETS by the parameter of the same name on the parameter page "Brightness limiting values (BLV)" so that the function can be configured and used.

Output functions

Up to three limiting values can be evaluated. Each limiting value has its own output object. The parameter "Number of limiting values to be controlled" defines how many limiting values and thus how many output objects are configurable in the ETS.

Each output can be configured independently to one of the following data formats by the parameter "Function"...

- "Switching" function:
1-bit switching telegrams (ON / OFF) can be output.
- "Brightness value" function:
It is possible to output 1-byte brightness value telegrams (0...100 %).
- "Scene extension" function:
It is possible to execute a 1-byte scene recall (0...64) in another bus subscriber via the output object of a limiting value.

4.2.4.3.1 Limiting value definition

A brightness limiting value to be monitored always consists of an upper and lower brightness threshold. The brightness thresholds are assigned via a limiting value and hysteresis derived relatively from the limiting value. The type of limiting value (upper or lower threshold) must be preset accordingly by the parameter "Limiting value definition".

Depending on the configuration, a limiting value output can transmit a telegram if the brightness value exceeds the upper threshold and/or falls below the lower threshold.

i The limiting value is configured in the ETS and can be changed during ongoing operation of the device either by an external presetting via the 2-byte object "Limiting value 1 external presetting" or by the Teach function (see page 62-63).

The hysteresis is a static value that is configured in the ETS. The hysteresis cannot be adapted during operation of the device. The device recalculates the hysteresis automatically if a new limiting value is preset.

Example of the limiting value definition:

1. Brightness limiting value = Upper threshold (Figure 30)
-> Lower threshold = brightness limiting value - hysteresis

2. Brightness limiting value = Lower threshold (Figure 31)
-> Upper threshold = brightness limiting value + hysteresis

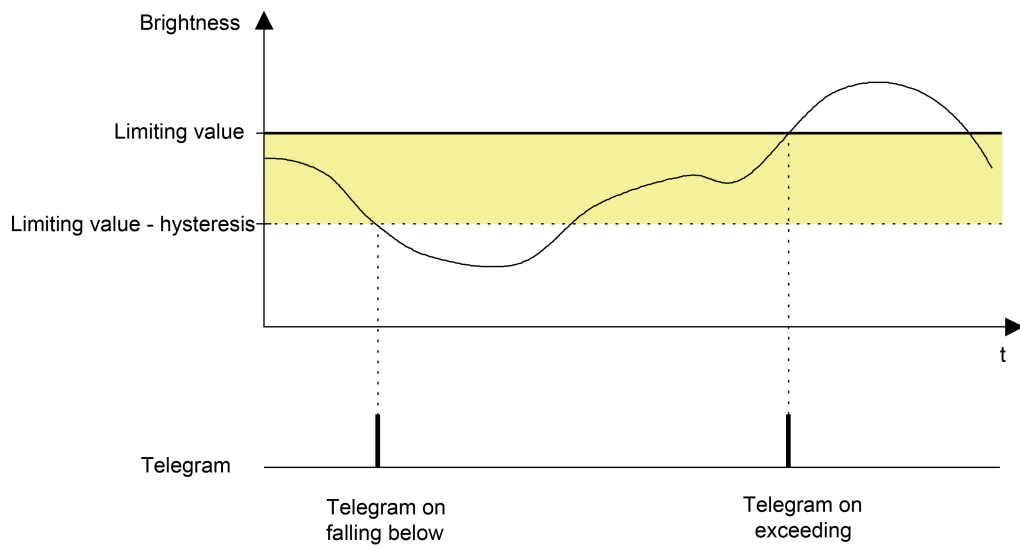

Figure 30: Example 1 of the limiting value definition
Limiting value is upper threshold

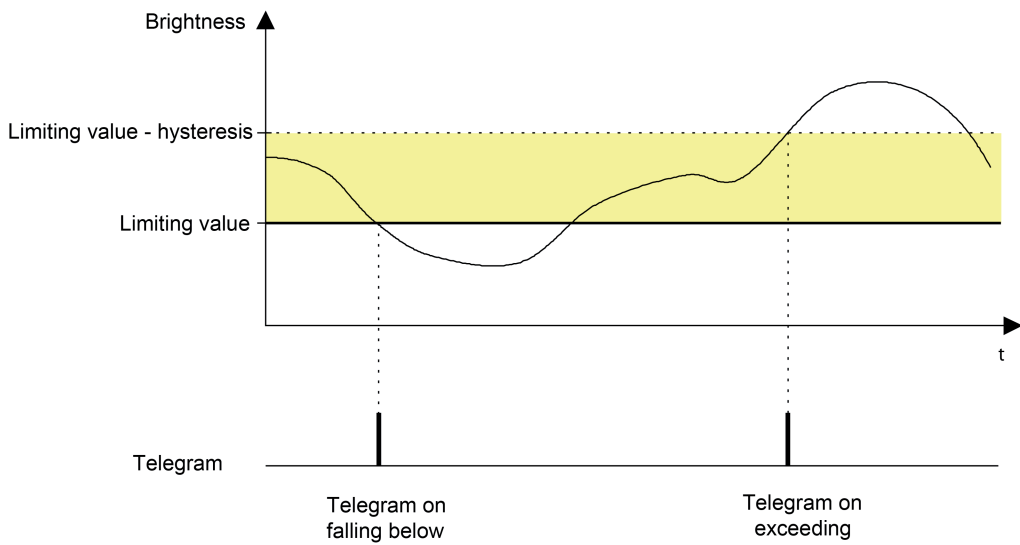

Figure 31: Example 2 of the limiting value definition
Limiting value is lower threshold

4.2.4.3.2 Limiting value presetting

During ongoing operation of the device, a brightness limiting value can be changed by an external presetting of a 2-byte brightness value via the object "Limiting value x external presetting" or by the Teach function and thus adapted to user requirements.

The 2-byte objects "limiting value x effective" can be used for the feedback of the limiting values evaluated by the device. These objects are configurable with group addresses if the parameter "Feedback 'limiting value effective'?" is set to "yes" per limiting value.

The feedback can optionally take place actively or passively (object is readable). In the function as an active signalling object, the current value is transmitted once automatically to the bus on each change of the brightness limiting value, after ETS programming or after bus voltage return (optionally delayed).

External presetting of the brightness limiting value

The brightness limiting value is reset in the device in accordance with DPT 9.004 by transmitting a 2-byte brightness value to the object "Limiting value x external presetting". The relative hysteresis value configured in the ETS results in a new value for both brightness thresholds depending on the type of limiting value definition. The new limiting value remains unchanged until a new presetting (externally via object or via Teach function). An ETS programming operation resets a limiting value automatically to the ETS presettings if this is provided for in the configuration (see below).

- i** A limiting value set via the 2-byte object will be lost during execution of the Teach function (see below).

Teach function

The Teach function is another possibility for the external presetting of a limiting value. With the Teach function, the currently measured brightness value is applied instantly by transmitting a corresponding telegram to the 1-bit object "Limiting value x Teach" as a new limiting value. The relative hysteresis value configured in the ETS results in a new value for both brightness thresholds depending on the type of limiting value definition.

The Teach object is configurable if the parameter "Teach function" is set to "enabled" on the parameter page "BLV - General". The polarity of a Teach telegram is configurable by the parameter "Teach operating mode". Depending on the configuration, it is possible to reset to the configured limiting value upon receiving the opposite object value (Teach inactive). The limiting value previously learned will be lost in the process. If, however, the Teach operating mode is configured to "1"- and "0"-active, it is not possible anymore to reset to the configured limiting value via this object during ongoing operation of the device! The new limiting value set with the Teach function remains unchanged until a new presetting (externally via object or by a new Teach function). An ETS programming operation resets a limiting value automatically to the ETS presettings if this is provided for in the configuration (see below).

- i** A limiting value set previously via the 2-byte object will be lost during execution of the Teach function. With the "Teach inactive" command, the brightness limiting value programmed by the ETS is always switched over to.
- i** Whenever several telegrams of the same polarity are received in succession on the Teach object with the "Teach active" command, a new save operation of the brightness limiting value is executed.

Limiting value presetting with ETS programming

The parameter "Overwrite limiting value in device for ETS download?" determines whether an actively set and active limiting value by previous external object presetting or by Teach is overwritten by the limiting value configured in the ETS during ETS programming. If the setting is "yes", the last value preset externally or by Teach and still active is replaced automatically by

the ETS presetting. If the setting is "no", the last limiting value preset externally or by Teach still remains active even after ETS programming.

- i If the parameter "Overwrite limiting value in device for ETS download?" is set to "no" and no external presetting has been made yet - if provided for in the configuration - via the 2-byte object or by Teach after the first ETS commissioning, the device always works with the value configured in the ETS. The ETS parameter only becomes invalid within the above configuration after an external presetting or after a Teach.
- i A bus voltage failure does not reset limiting values preset by the 2-byte object or by Teach. The disabling function has no effect on the external presetting of a new limiting value.

4.2.4.3.3 Disabling function

The limiting value evaluation can be disabled independently of the other functional units via the disabling function. A disabled limiting value evaluation is deactivated. No telegrams are then transmitted anymore via the output objects. The presetting of new brightness limiting values by an external brightness value or by the Teach function is not influenced by the disabling function, however.

The disabling function can be used if the parameter "Use disabling function?" is configured on the parameter page "BLV - Disable" to "yes". The disabling function is then activated and deactivated via the object "BLV - Disable input" in which the ETS telegram polarity is configurable. The disabling function can be activated by force after bus voltage return or after ETS programming.

Disabling function after bus voltage return

The state of the disabling function after bus voltage return is configurable and can be configured to the following settings...

- Setting "deactivated":
After bus voltage return, the brightness limiting values are ready for operation immediately. The configured thresholds for each output are compared with the current brightness value and evaluated. If the brightness value exceeds or does not reach the corresponding thresholds, the configured telegrams are transmitted.
- Setting "activated":
After bus voltage return, all brightness limiting values are disabled. The configured thresholds are not evaluated with the current brightness value. Thus, no telegram is transmitted via any output.
- Setting "state as before bus voltage failure":
If the device detects a bus voltage failure, it saves the current state of the disabling function. After bus voltage return, the disabling function adopts the saved state again (active or inactive).

Disabling function after ETS programming

The state of the disabling function after ETS programming is also configurable. The state can be configured as follows...

- Setting "deactivated":
After ETS programming, the brightness limiting values are ready for operation immediately. The configured thresholds for each output are compared with the current brightness value and evaluated. If the brightness value exceeds or does not reach the corresponding thresholds, the configured telegrams are transmitted.
- Setting "activated":
After ETS programming, all brightness limiting values are disabled. The configured thresholds are not evaluated with the current brightness value. Thus, no telegram is transmitted via any output.

4.2.4.4 General reset behaviour

The device - depending on configuration - has various feedback objects. These objects can be configured as "actively transmitting" so that a feedback telegram can be transmitted automatically to the bus when the state changes. These objects then transmit the current object value constantly even after bus voltage return in order to initialize other bus subscribers. A high telegram load can result after bus voltage return, particularly in large KNX systems with many sensors. To counteract such an overload, a transmission delay after bus voltage return is configurable with this device. This transmission delay only takes effect for automatically transmitting objects of the device after bus voltage return and is configured by the parameter "delay after bus voltage return" on the parameter page "General". It is recommended to configure different delay times in the individual sensors so that the devices do not transmit at the same time.

-  The delay is not active after ETS programming. In this case, the actively transmitting objects transmit their status immediately once the device has been restarted after the reset.

The light control can be set by configuration to a defined behaviour after bus voltage return or after ETS programming. For this purpose, the parameters "Behaviour after bus voltage return" and "Behaviour after ETS programming" are provided and are available on the parameter page of the light control.

The disabling function of the brightness limiting values can also be active automatically after bus voltage return or an ETS programming operation, depending on requirements. The disabling function has its own parameters for this purpose.

4.2.4.5 Delivery state

In the unprogrammed delivery state, the device behaves passively. It transmits no telegrams to the bus. As soon as the device has been programmed in the ETS, it is ready for operation.

4.2.5 Parameters

Description	Values	Comment
<input type="checkbox"/> General		
Delay after bus voltage return Minutes (0...59)	0...59	<p>The device - depending on configuration - has various feedback objects. These objects can be configured as "actively transmitting" so that a feedback telegram can be transmitted automatically to the bus when the state changes. These objects then transmit the current object value constantly even after bus voltage return in order to initialize other bus subscribers. A high telegram load can result after bus voltage return, particularly in large KNX systems with many sensors. To counteract such an overload, a transmission delay after bus voltage return is configurable here. This transmission delay only takes effect for automatically transmitting objects of the device after bus voltage return. It is recommended to configure different delay times in the individual sensors so that the devices do not transmit at the same time.</p> <p>The delay is not active after ETS programming. In this case, the actively transmitting objects transmit their status immediately once the device has been restarted after the reset.</p> <p>Setting the delay time minutes.</p>
Seconds (0...59)	0...17...59	<p>Setting the delay time seconds.</p>
<input type="checkbox"/> Light sensor		
Transmitting the brightness value	on change cyclical on change and cyclical only on read request	<p>The brightness value determined by the device can be made available to the KNX system via the 2 byte-communication object "Measured brightness value". The device can transmit the brightness value actively and/or cyclically for a configured brightness change. It is also possible to only provide the brightness value passively and to transmit this on request. This parameter determines the transmission behaviour.</p>
Transmit on brightness change by (5...200 Lux)	5 Lux...20 Lux...200 Lux in 5-Lux increments	<p>This parameter defines the value by which the brightness value determined by the device must change so that this can be transmitted automatically to the bus.</p> <p>This parameter is only visible with the setting "transmission of the brightness value = on change" or "transmission of</p>

		the brightness value = on change and cyclical".
Time for cyclical transmission Minutes (0...59)	0... 3 ...59	This parameter defines the time interval between two telegrams for the cyclical transmission of the brightness value. Setting the cycle time minutes.
Seconds (0...59)	0 ...59	Setting the cycle time seconds. These parameters are only visible with the setting "transmission of the brightness value = cyclical" or "transmission of the brightness value = on change and cyclical".
Sensor calibration	Factory calibration Calibration by telegram	The value for the brightness to be determined on the work surface or floor surface by the device depends on the measured brightness. The brightness is derived from the reflected brightness on the underlying surface. To determine the brightness on the measuring surface from the measured brightness, the reflection coefficient of the surface must be known. In the factory calibration, the reflection coefficient for the measuring surface is set to 0.3. This already makes an adjustment to many surfaces possible. To compensate for any deviations of the determined brightness during factory calibration to the real brightness on the work surface, the brightness measurement can be calibrated using a calibration function (adjustment of the reflection coefficient) and thus adapted to special surface finishes (setting: "Calibration by telegram"). During calibration, an externally preset brightness value at the workplace is assigned to the currently measured brightness on the light guide. This presetting is made via the 2-byte communication object "sensor calibration".
Behaviour in the event of a calibration not carried out	Do not transmit brightness value transmit invalid brightness value (\$7FFF)	When the parameter "sensor calibration" is set to "calibration by telegram", the device will not evaluate any brightness until a user calibration has been carried out. In this case, the light control will therefore have no function until a calibration has been carried out properly. The brightness value tracked via the object "Measured brightness value" can be influenced by this parameter in the event of a calibration not yet carried out. Depending on the

		setting, the device will either transmit no brightness value (value "0" in the object) or the value "7FFF" (hexadecimal) to indicate an invalid brightness measured value.
☐ Light control (LC)		
Light control	disabled enabled	This parameter enables the light control. If light control is enabled, all parameters and communication objects necessary for the light control are visible.
☐ LC - General		
Effect of the brightness value-feedback on the actuator	active signalling object passive status object	It is necessary to know the current brightness level of the activated KNX actuator for some control processes (e.g. after ETS programming, after bus voltage return or after manual control intervention in the lighting). For this purpose, the brightness value-feedback of an actuator from output channel 1 must always be linked to the object "Feedback brightness value" of the light control. This parameter informs the light control as to how the actuator performs the feedback. This can then take place by actively transmitting (the actuator transmits the brightness value independently on change) or alternatively, passively (the actuator does not transmit independently / it is requested by the object of the light control via a read telegram). Thus, the setting of this parameter must be adapted to the configuration of the actuator.
Behaviour after bus voltage return		The behaviour of the light control after bus voltage return can be defined here.
	no reaction	With this setting, the light control is in normal state after bus voltage return. It can be activated and operated regularly.
	Activate disabling function	With this setting, the light control is set to the disabling state after bus voltage return. The configured behaviour is executed at the beginning of the disabling function.
	state of disable fct as before bus voltage failure	With this setting, the disabling state of the light control is adopted as it was before bus voltage failure. If the disabling function should be activated, the configured behaviour is executed at the beginning of the disabling function.

Behaviour after ETS programming

no reaction

The behaviour of the light control after ETS programming is definable here.

With this setting, the light control is in normal state after ETS programming. It can be activated and operated regularly.

Activate disabling function

With this setting, the light control is set to the disabling state after ETS programming. The configured behaviour is executed at the beginning of the disabling function.

Adaptation of the control dynamic in the brightness range

The light control needs certain parameters that define the brightness range in the room. These parameters are important for calculating certain control characteristics from which, among other things, the control dynamic and thus the subjective perceived comfort of the feedback control are derived. This parameter defines whether the light control works with standard control parameters that the manufacturer has predefined and generally adapted to many applications, or whether the control parameters can be customized.

Standard

The light control works with a standard configuration preset by the manufacturer. The control dynamic is thus adapted effectively to very many applications. The maximum illuminance is then not configurable in the ETS. This is calculated automatically depending on the setpoint configured in the ETS (factor x 1.2) and entered in the light control. When dimensioning the lighting system on-site, it must be ensured that the installed lighting can always supply brightness levels that correspond to the value "configured setpoint x 1.2". The lower brightness threshold is preconfigured to 0 Lux with this setting (no special control dynamic in the lower brightness range).

user-defined

With user-defined control dynamic the maximum illuminance (10...2,000 Lux) and lower brightness threshold (0...2,000 Lux) can be configured in the ETS. In this way, it is possible to customize the control parameters to special applications.

<p>Maximum illuminance "Maximum value" (10...2,000 Lux)</p>	<p>10...720...2,000</p>	<p>The required control parameters in user-defined setting include the information regarding which maximum illuminance can be set by the lighting in the room (artificial light). In the case of a large difference between the brightness in the room and the setpoint, this maximum value defines larger control output changes or increments and thus increases the control dynamic (fast adjustment to the setpoint by larger control output commands). The maximum illuminance is also used for calculating the control output for the adaptive start up control. This control parameter must be configured to the maximum brightness value adjustable by the lighting (P-component of the light control). The maximum value of the lighting is typically a factor of 1.2 higher than the setpoint configured in the ETS. When configuring the control parameters, the following dependency should be noted: Lower brightness threshold < Setpoint < Maximum illuminance.</p>
<p>Lower brightness threshold "darkness value" (0...2,000 Lux)</p>	<p>0...200...2,000</p>	<p>The darkness value of the room lighting (lower brightness threshold) is also decisive for the light control. If the lower brightness threshold is fallen below, the time between the control output telegrams is shortened thereby resulting in a higher control dynamic here as well. When configuring the control parameters, the following dependency should be noted: Lower brightness threshold < Setpoint < Maximum illuminance.</p>
<p>Setpoint</p>	<p>20 Lux, 50 Lux, 100 Lux, ... 600 Lux, ... 1,000 lux from 50 Lux in 50-Lux increments</p>	<p>The brightness setpoint corresponds to the value of the desired brightness that the light control is to set and keep as constant as possible with the aid of an assigned lighting device while taking changing external light influences into account. During the control phase, the lighting is only readjusted if the measured brightness value is not within the preset setpoint range. The lower limiting value of the setpoint range is preset directly by the "setpoint" (Setpoint range = setpoint + hysteresis). The "setpoint" thus represents the minimum brightness to be maintained. This parameter defines the setpoint. The possible adjustment range of the parameter depends on the configuration</p>

		of the control dynamic. In a standard control dynamic, this parameter is visible. The setpoint can thus be configured within the range from 20 Lux to 1,000 Lux. As a result, virtually all standard applications are covered.
Setpoint (10...2,000 Lux)	10... 600 ...2,000	<p>The brightness setpoint corresponds to the value of the desired brightness that the light control is to set and keep as constant as possible with the aid of an assigned lighting device while taking changing external light influences into account. During the control phase, the lighting is only readjusted if the measured brightness value is not within the preset setpoint range. The lower limiting value of the setpoint range is preset directly by the "setpoint" (Setpoint range = setpoint + hysteresis). The "setpoint" thus represents the minimum brightness to be maintained.</p> <p>This parameter defines the setpoint. The possible adjustment range of the parameter depends on the configuration of the control dynamic. In user-defined control dynamic, this parameter is visible. The setpoint is thus continuously configurable within a range from 10 Lux to 2,000 Lux. This allows extended setpoint presettings for special applications.</p>
Hysteresis setpoint (+10...+50 %)	10 ...50	<p>In order to avoid permanent readjustment of the connected lighting device due to slight brightness and measurement value fluctuations, a setpoint range with a lower and upper limiting value is defined for the setpoint presetting. The upper limiting value is determined by the presetting of a relative hysteresis value (percentage) in relation to the setpoint.</p> <p>This parameter defines the hysteresis value. In this way, the upper limit of the setpoint range is derived directly from the effective setpoint.</p>
Overwrite setpoint in device for ETS-download?	yes no	<p>This parameter determines whether an actively set and active setpoint set by previous external object presetting or by Teach is overwritten automatically by the setpoint configured in the ETS during ETS programming. If the setting is "yes", the last value preset externally or by Teach and still active is replaced by the ETS presetting. If the setting is "no", the last setpoint preset externally</p>

		<p>or by Teach still remains active even after ETS programming. If the parameter is set to "no" and no external presetting has been made yet - if provided for in the configuration - via the 2-byte object or by Teach after the initial ETS commissioning, the device always works with the value configured in the ETS. The ETS parameter only becomes invalid within the above configuration after an external presetting or after a Teach.</p>
Object "Preset setpoint"	<p>disabled</p> <p>enabled</p>	<p>The currently set brightness setpoint can be reset in accordance with DPT 9.004 by transmitting a 2-byte brightness value to the object "Preset setpoint". The object is configurable if this parameter is set to "enabled". The setpoint received via the object remains unchanged until a new setpoint presetting (by means of external setpoint presetting, setpoint shift or Teach) or until a new reset command to the object "Setpoint Reset". Even a bus voltage failure will not reset the brightness setpoint received via the bus. An ETS programming operation resets the setpoint automatically to the ETS presettings if this is provided for in the configuration.</p>
Allow setpoint shift?	<p>yes</p> <p>no</p>	<p>With the setpoint shift the setpoint can be changed within the configured limits during the control phase by direct control of the assigned lighting. The setpoint shift is enabled when this parameter is set to "yes". The setpoint shift is started by transmitting relative 4-bit dimming telegrams to the object "setpoint shift" during the control phase. At the same time, the light control controls the lighting via the relative dimming object of the first channel and thereby sets another brightness value. When the desired brightness is reached, a stop telegram must be received via the object "setpoint shift" which is then transmitted to channel 1 and output to the lighting.</p>
Upper limit setpoint shift (10...2,000 Lux)	<p>10...2,000</p>	<p>The upper limiting value of the setpoint shift is configured here. If this upper limiting value is exceeded during the setpoint shift, the setpoint shift then stops automatically after detecting that the limiting value has been exceeded. The device then transmits a stop telegram to the bus via channel 1. The</p>

		<p>corresponding limiting value is then applied as new setpoint value instead of the set brightness value. This parameter is only visible if setpoint shift is enabled.</p>
<p>Lower limit setpoint shift (10...2,000 Lux)</p>	<p>10...2,000</p>	<p>The lower limiting value of the setpoint shift is configured here. If this lower limiting value is fallen below during the setpoint shift, the setpoint shift stops automatically after detecting this. The device then transmits a stop telegram to the bus via channel 1. The corresponding limiting value is then applied as new setpoint value instead of the set brightness value. This parameter is only visible if setpoint shift is enabled.</p>
<p>Validity of the setpoint shift</p>	<p>temporary till end of the current control phase</p> <p>permanently</p>	<p>With this parameter it is possible to define in the ETS whether a setpoint shift should only apply temporarily for the control phase that is currently active, or alternatively, should be applied permanently. If the setpoint shift is applied permanently, the set setpoint remains unchanged until a new setpoint presetting (by means of external setpoint presetting, setpoint shift or Teach) or until a new reset command via the object "Setpoint Reset". Even a bus voltage failure will not reset the brightness setpoint value. An ETS programming operation resets the setpoint automatically to the ETS presettings if this is provided for in the configuration. This parameter is only visible if setpoint shift is enabled.</p>
<p>Teach function</p>	<p>disabled</p> <p>enabled</p>	<p>With the Teach function, the effective brightness value is applied instantly by transmitting a corresponding telegram to the 1-bit object "Setpoint Teach" as a new brightness setpoint. The object is configurable if this parameter is set to "enabled".</p>
<p>Teach operating mode</p>	<p>0 = inactive / 1 = active</p> <p>0 = active / 1 = inactive</p> <p>0 = active / 1 = active</p>	<p>The polarity of a Teach telegram is configurable by this parameter. Depending on the configuration, it is possible to reset to the configured setpoint upon receiving the opposite object value (Teach inactive). The setpoint previously learned will be lost in the process. If, however, the Teach</p>

		<p>polarity is configured to "1"- and "0"-active, it is not possible anymore to reset to the configured setpoint via this object during ongoing operation of the device!</p> <p>This parameter is visible only if the teach function is enabled.</p>
Feedback "Setpoint effective"?	<p>yes</p> <p>no</p>	<p>The object "setpoint effective" that can be enabled by this parameter can be used for the feedback of the setpoint set effectively in the light control (lower limit setpoint range).</p>
Effect of the feedback	<p>active signalling object</p> <p>passive status object</p>	<p>The object "setpoint effective" contains the active setpoint of the light control and can either transmit the value actively on change, or make it available passively. As an active signalling object, the current value is transmitted once automatically to the bus on each change of the setpoint, after ETS programming or after bus voltage return (optionally delayed).</p> <p>This parameter is only visible if the feedback object is enabled.</p>
Number of lighting channels to be controlled	<p>1 (Channel 1)</p> <p>2 (Channel 1, 2)</p> <p>3 (Channel 1, 2, 3)</p>	<p>The light control can control up to three lighting groups. Up to 3 output channels are available for this purpose. It is possible to adapt control outputs for various installation locations of the lighting groups in the room by using several channels, for example. Thus, a lighting group near the window, for example, can be controlled by small control outputs as lighting in the centre of the room. These with less control outputs, used in turn as lighting in a remote recess.</p> <p>The number of channels can be defined via this parameter.</p>
<p>The following parameters is only configurable in the case of 2 or 3 channels...</p>		
Offset behaviour for channel 2 / for channel 2 and 3		<p>If several channels are used, the control output of the feedback control in the startup and main control phase only takes place with absolute 1-byte dimming values. The basic regulation</p>

		(control output calculation) always relates to channel 1. The control outputs of channels 2 and 3 are always calculated in relation to the control output of the first channel via corresponding offset settings. Three methods are available for calculating the control outputs of channel 2 and 3. This parameter defines which method is used.
	Offset fixed with increasing control output	If this method is chosen, a fixed offset value is selected for channels 2 and 3 for the output control of the first channel. The offset remain constant across the entire control output range. The offset calculation always starts from the control output "1" of channel 1. For the control output "0" (OFF), the control outputs of channel 2 and 3 are also set to "0".
	Offset increasing with increasing control output	With this method, the offset value is increased for channel 2 or 3 with increasing control outputs of channel 1. This takes place until channel 2 or 3 has reached the limiting value 255. The offset settings for the control outputs of channel 2 and 3 are specified in percentage relative to the control output of channel 1. Offset settings less than 100 % result in a negative offset value and offset settings greater than 100 % result in a positive offset value for the control output of the first channel.
	Offset decreasing with increasing control output	With this setting, the offset value for channel 2 or 3 is reduced continuously from the start offset with increasing control outputs of the first channel until a limiting control output of channel 1. The offset for channels 2 and 3 is always "0" from the limiting control output of channel 1 which results in a synchronization of the output channels. The offset calculation always starts from the control output "1" of channel 1. For the control output "0" (OFF), the control outputs of channel 2 and 3 are also set to "0".
ON-OFF hysteresis in the case of negative offset Channel 2 / Channel 2 und 3 (0...90)	0... 20 ...90	To prevent channels 2 and 3 from being switched too frequently in the case of negative offset in the threshold range, an ON-OFF hysteresis can be configured in relation to the control outputs of channel 1. The ON-OFF hysteresis should be less than the offset value for channel 1 or less than the start offset. This parameter is only visible with the offset behaviour "Offset fixed with increasing control output" and "Offset

		decreasing with increasing control output".
Offset Channel 2 to channel 1 (-128...127)	-128... 50 ...127	This parameter defines the static offset to channel 1 for the second channel with the offset behaviour "Offset fixed with increasing control output".
Offset Channel 3 to channel 1 (-128...127)	-128... -50 ...127	This parameter defines the static offset to channel 1 for the third channel with the offset behaviour "Offset fixed with increasing control output". This parameter is only visible if 3 channels are available.
Offset Channel 2 to channel 1 (1...200 %)	0... 150 ...200	This parameter defines the relative offset to channel 1 for the second channel with the offset behaviour "Offset increasing with increasing control output".
Offset Channel 3 to channel 1 (1...200 %)	0... 50 ...200	This parameter defines the relative offset to channel 1 for the third channel with the offset behaviour "Offset increasing with increasing control output". This parameter is only visible if 3 channels are available.
Start offset Channel 2 to channel 1 (-128...127)	-128... 50 ...127	To configure the offset setting "Offset decreasing with increasing control output", a start offset must be preset for channel 2.
Start offset Channel 3 to channel 1 (-128...127)	-128... -50 ...127	To configure the offset setting "Offset decreasing with increasing control output", a start offset must be preset for channel 3. This parameter is only visible if 3 channels are available.
Control output from channel 1 for synchronization to Channel 2 (0...255)	0... 200 ...255	To configure the offset behaviour "Offset decreasing with increasing control output", a control output from channel 1 must be preset for the synchronization to channel 2 (no more offset available in the case of larger control outputs).
Control output from channel 1 for	0... 200 ...255	To configure the offset behaviour "Offset decreasing with increasing control

synchronization to
Channel 3
(0...255)

output", a control output from channel 1 must be preset for the synchronization to channel 3 (no more offset available in the case of larger control outputs). This parameter is only visible if 3 channels are available.

☐ LC - Control behaviour

Startup control
behaviour

The start up control phase represents the start behaviour of the light control and should quickly ensure sufficient brightness in the room. For this purpose, the brightness value setpoint is compared with the measured brightness value at the beginning of the startup control phase. If the measured value is greater or equal to the setpoint, the main control state is changed to immediately. If the measured value is below the setpoint, the configured startup control behaviour is executed.

Switch on

If the currently determined brightness value is less than the preset setpoint, the light control switches on the assigned lighting via a switching telegram (1-bit). The lighting is activated by the channel object "Switching". This setting cannot be selected in the case of 2 or 3 channels.

Control output presetting
(relative dimming)

If the currently determined brightness value is less than the preset setpoint, the light control dims up the lighting via cyclically output dimming step telegrams until the brightness value has reached or even exceeded the setpoint. The increment of the dimming telegrams and the time for the telegram repetition are configurable (optional). After reaching or exceeding the setpoint limit, a stop telegram is transmitted. In the case of dimmer actuators with steep dimming curves, slight overshooting may occur that is then offset again by the main control phase. The lighting is activated by the channel object "Switching". This setting cannot be selected in the case of 2 or 3 channels.

**Control output presetting
(brightness value)**

If the light control detects a lower brightness value than the preset setpoint, the lighting is then switched on by transmission of a configured dimming value. If a higher brightness value is preset (e.g. 100 %), this results in a brightness jump (like when switching on), which is then offset again by the main control phase if the higher brightness value is not required. The

		lighting is activated by the channel object "brightness value".
	Ctr output presetting adaptive (brightness value)	With this startup control behaviour, depending on the currently measured brightness by the light control, a control output (1-byte) is calculated and transmitted automatically by means of the setpoint presetting and defined brightness range in order to approximately reach the exact setpoint range. The lighting is activated by the channel object "brightness value".
Dimming step width	100 % 50 % 25 % 12.5 % 6 % 3 % 1 %	If the startup control behaviour is executed via relative dimming commands (4-bit), the dimming step width can be configured here.
Telegram repetition	yes no	If the startup control behaviour is executed via relative dimming commands (4-bit), a telegram repetition can be configured here. A telegram repetition is advisable if the dimming step width is configured to values less than 100 % and should still be dimmed across the entire brightness range. Dimming processes can thus also be executed more smoothly in the actuators even in the case of steep dimming curves.
Time for telegram repetition Seconds (0...59)	0...59	The time for the cyclical telegram repetition is configure here. Setting the telegram repetition seconds.
Milliseconds (0...9 x 100)	0...5...9	Setting the telegram repetition milliseconds. This parameter is only visible if the telegram repetition is activated.
Waiting time after start up control Seconds (1...59)	1...5...59	Before changing from the start up control phase to the main control phase, the activated actuator should have reached its final value so that the feedback control can control with stable actuator states. For this purpose, the waiting time configurable here is started after the startup control phase. The main control phase is only changed to after this waiting time has elapsed. The length of the waiting time should be adapted to the startup control method used (e.g. longer waiting time with

		relative startup control behaviour) and the characteristics of the connected actuator (fast or slow dimming speed).
Control behaviour	Control output presetting (relative dimming) Control output presetting (brightness value)	In the main control phase, the light control adjusts the brightness of the lighting continuously to the active setpoint. At the same time, the data format used of the control outputs is configurable by the ETS parameter "control behaviour". Alternatively, the lighting can be activated by absolute brightness value telegrams (channel object "brightness value") or by relative dimming step telegrams (channel object "dimming"). The setting "control output presetting (relative dimming)" cannot be selected in the case of 2 or 3 channels.
Minimum dimming step width	12.5 % 6 % 3 % 1 %	This parameter defines in which steps the light control can dim the lighting by one telegram each, in the case of relative control output presetting.
Minimum control output change per dimming step (2...32)	2... 4 ...32	This parameter defines in which steps the light control can dim the lighting by one telegram each, in the case of absolute control output presetting.
Minimum repeat time for control outputs Seconds (1...59)	1... 2 ...59	This parameter specifies for the light control how long the minimum waiting time between two control output telegrams must be. Small dimming steps (relative 1...3% / absolute 2...10) with short repeat times (2...10 seconds) should normally be specified so that the light control is executed interruption-free and is subjectively pleasant. Since the dimming speed is primarily defined by the configuration of the actuator, the parameter of the light control should therefore be adapted to the dimming times of the actuators.
Influence behaviour in case of lower control output limit?		When switching off the lighting in the room using the light control, it should be ensured during the main control phase that the lighting is not switched on again immediately by falling below the setpoint due to the light jump. For this purpose, the lower control output limit can be evaluated and a switch-off brightness can be configured.

	yes	The light control only evaluates the lower control output limit if this parameter is set to "yes". In this case, it is possible to set additional parameters that specify the behaviour exactly.
	no	In the setting "no", no evaluation of the lower control output takes place. This is then set to the smallest possible control output. No reaction occurs once the lower control output limit is reached, whereby in this configuration a switch-off is not possible during the main control phase.
Lower control output limit (1...128)	1...128	<p>In the case of an absolute control output presetting - if this is evaluated - the lower control output limit is defined by this parameter within the range of 1...128 (0.4%...50%). The lower control output limit is preset to "1" if the behaviour of the control should not be influenced by the lower control output limit.</p> <p>In the case of relative control output presetting, the lower control output limit cannot be configured. In this configuration, the device calculates rather the lower control output limit itself by means of the configured minimum dimming step width. The relative dimming step telegrams transmitted to the actuator then enable the light control to detect during the ongoing control process whether or not the lower control output limit has been reached. It is important that the activated KNX dimmer actuators can be dimmed to the lowest brightness level (basic brightness). The dimmable brightness range must not be limited by a minimum brightness on the actuators!</p>
Behaviour if lower control output limit is fallen below	no reaction	The behaviour if the lower control output limit is fallen below can be configured here.
	Switch off at switch-off brightness	Once the lower control output limit is reached, the light control no longer reacts. A switch-off does not takes place. The control output remains unchanged until the control has to dim up the lighting again or until the step down control phase is started due to the presence signal.
		As soon as the lower control output limit is reached and the switch-off brightness in the room has also been reached or exceeded, the light control switches off

		the lighting. The additional hysteresis for the switch-off brightness can only be configured in this setting.
Additional hysteresis setpoint for switch-off brightness (0...+100 %)	0... 10 ...100	After reaching the lower control output limit, the switch-off brightness in the room must also be reached or exceeded so that the lighting is switched off automatically during the main control phase. The switch-off brightness is above the setpoint + hysteresis. The switch-off brightness is derived from an additional relative hysteresis value that is added to the hysteresis value of the setpoint: Switch-off brightness = setpoint + (setpoint x (hysteresis setpoint + additional hysteresis switch-off brightness)) The additional hysteresis for the switch-off brightness is configured here.
Behaviour at the beginning of the step down control phase	switch off immediately transmit minimum control output transmit configured control output	The behaviour at the end of the control is determined in the step down control phase. This behaviour is defined by this parameter. The assigned lighting device can optionally be switched off immediately or first dimmed down to minimum brightness by transmitting the minimum control output. As a further alternative, it is possible for the device to transmit a configured control output (1...100 %).
The following parameters for the step down control phase are only visible if a minimum or configured control output should be transmitted...		
Step down control behaviour	Control output presetting (relative dimming) Control output presetting (brightness value)	This parameter (value telegram "1" or dimming step telegram 100%) defines with which data format the minimum control output is transmitted. When transmitting a configured control output, the step down control behaviour must always be preset to "control output presetting (brightness value)".
Control output (1...100 %)	1... 50 ...100	This parameter defines the control output transmitted at the beginning of

<p>Additional waiting time after step down control (Standard waiting time = 10 s) Minutes (0...59)</p>	<p>0...59</p>	<p>the step down control phase. The parameter is only available in the setting "Behaviour at the beginning of the step down control phase = Transmit configured control output"!</p>
<p>Seconds (0...59)</p>	<p>0...59</p>	<p>If the brightness is to be dimmed down to minimum brightness, a waiting time is started before starting the dimming process. The duration of the waiting time is derived from a standard waiting time (10 seconds) plus an additional waiting time that can be configured here. The standard waiting time ensures that the minimum brightness also can actually be set by the activated dimmer actuators before the end of the step down process. Setting the waiting time minutes. Setting the waiting time seconds.</p>
<p>Behaviour on new presence detection during waiting time</p>	<p>ignore presence detection</p>	<p>During an ongoing waiting time in the step down control phase, a new presence can be transferred to the light control if, for example, people are present again in the room. In this case, this parameter defines how the light control should behave.</p>
	<p>Cancel step down phase and startup control anew</p>	<p>In this setting, a presence detection is ignored. The light control then executes the step down control phase interruption-free until the end as preset. If the presence signal is still present at the end of the step down control phase, the light control restarts the startup control phase. In this setting, the step down control phase is cancelled immediately during the detection of a new presence and the startup control phase is started at once interruption-free.</p>
<p>Behaviour after the waiting time has elapsed</p>	<p>Keep control output Switch off</p>	<p>After the waiting time has elapsed, this parameter decides which state the lighting adopts at the end of the control process. With the setting "switch off", the light control finally switches off the lighting. As an alternative to switching off, the minimum control output can also be kept constant. This setting is appropriate, for example, if a permanent basic brightness is to be set in the room (e.g. in long corridors or passageways).</p>

Switch off by	Switching telegram (1-bit) Brightness value telegram (1-byte)	Here, you define with which data format the switch-off takes place at the end of the step down control phase.
□ LC - Disable / Superimposed operation		
Polarity of disable object	0 = enable / 1 = disable 0 = disable / 1 = enable	This parameter defines the telegram polarity of the disabling object.
Feedback "Status disabling function light control"?	yes no	Optionally, the disabling status of the light control can be made available via the 1-bit object "Status disabling function light control". For this purpose, this parameter must be set to "yes". The disabling status is influenced by the disabling function and by the superimposed operation. A "1" indicates an active disabling function of the light control.
Effect of the feedback	active signalling object passive status object	The light control - if the object was enabled - transmits its own disabling status depending on this parameter either actively to the bus on each change, or it only provides the object value passively (object is readable).
Behaviour at the beginning of the disabling function	disable and send no telegram disable and send telegram execute disable and step down control behaviour	This parameter defines the behaviour of the light control if the disabling function is activated. At the start of disabling, no telegrams are transmitted via the outputs. The assigned lighting is not influenced. At the start of the disabling function, freely configurable switching or brightness value telegrams can be output via the output channels in order to set the assigned lighting to the desired state. The telegrams are configured separately for each channel. With this setting, the configured step down control behaviour is executed on activation of the disabling function. Presence signals are ignored during execution of the step down control behaviour.
Data format of the telegram	Switching telegram (1-bit)	Here, it is defined which data format should activate the lighting of a channel at the beginning of the disabling

	<p>Brightness value telegram (1-byte)</p>	<p>function. By setting the parameter you select whether the activation takes place via the 1-bit switching object or 1-byte brightness value object of a channel. This parameter is available separately for each channel and is only visible if the behaviour is configured to "disable and transmit telegram" at the beginning of the disabling function.</p>
<p>Telegram at the beginning of the disabling function</p>	<p>ON telegram OFF telegram</p>	<p>Here, the switching command of an output channel at the beginning of the disabling function is defined. This parameter is available separately for each channel and is only visible if the behaviour is configured to "disable and transmit telegram" at the beginning of the disabling function and the data format of the telegram is set to "switching telegram (1-bit)".</p>
<p>Dimming value at the beginning of the disabling function (0...100 %)</p>	<p>0...100</p>	<p>Here, the dimming value of an output channel at the beginning of the disabling function is defined. This parameter is available separately for each channel and is only visible if the behaviour is configured to "disable and transmit telegram" at the beginning of the disabling function and the data format of the telegram is set to "brightness value telegram (1-byte)".</p>
<p>Behaviour at the end of the disabling function</p>	<p>enable and send no telegram</p>	<p>On ending the disabling function, the light control is reset and the basic state (state OFF, no presence) set. The device then stops ongoing disabling reactions (e.g. step down control behaviour) immediately. This parameter defines the behaviour of the light control at the end of the disabling function. With this setting, the light control after enabling is internally in the state OFF and reacts to the newly received presence according to the configuration. The lighting state, which might have been changed externally during an active disabling function depending on the application, must be taken into account when enabling! At the end of the disabling function, the current existing lighting state will not be changed until new presence information by the light control. If control output presettings are made via absolute brightness values, the 1-byte object "Feedback brightness value" of the light control must be connected to an</p>

		actuator feedback object of channel 1 so that the light control knows the output state of the lighting. Otherwise, the light control may be adversely affected thereby resulting in erratic control behaviour.
	enable and switch off	At the end of the disabling function, the assigned lighting is switched off via the switching outputs in order to restore a defined basic state of the lighting. If a presence exists or a new presence is received, the control is restarted according to the measured brightness.
	execute enable and startup control behaviour	With this setting, a presence signal is activated artificially at the end of the disabling function. As a result, the startup control behaviour is executed automatically at the appropriate brightness value (determined brightness < value setpoint). The main control phase is then changed to. The further behaviour of the control process is dependent on the actual presence information.
Allow superimposed operation?	yes	With the superimposed operation, the assigned lighting device can be activated directly, for example, via a pushbutton or operating panel. In addition, the manually triggered switching or dimming commands to the lighting also have to be transmitted to the lighting control. For this purpose, the light control has 4 objects each with different data formats ("Input superimposed operation" - 1-bit switching, 4-bit relative dimming, 1-byte brightness value, 1-byte scene extension). By "listening in" to the telegrams via the named objects, the light control is disabled during the superimposed operation, whereby the lighting is no longer influenced by the control but only by the user. The objects of the superimposed operation are configurable if this parameter is set to "yes". Otherwise (setting "no"), a superimposed operation of the light control is not possible.
	no	
Enabling after superimposed operation		The behaviour of the light control at the end of the superimposed operation is defined by this parameter.
	automatic at the end of the presence	With this setting, the control is enabled automatically at the end of the tracked presence detection and the step down control behaviour is executed. A

distinction must be made here between the following cases:
 Light control in combination with function block 1: The automatic setting of the presence at the beginning of the superimposed operation ensures that the superimposed operation is always ended automatically in this application at the end of the presence detection after the transmission delay has elapsed and the step down control behaviour is executed. Additional (manual) intervention in the presence signal is not necessary here.

Autonomous operation of the light control: With this application, the end of the presence (deactivation of the presence information) must be received actively via the object "Presence" in order to end the superimposed operation and execute the step down control behaviour. In this case, the superimposed operation can be ended alternatively via the disabling object (see setting "only via disabling object").

only via disabling object

With this setting, the disabling of the control after a superimposed operation can only be cancelled with an enabling telegram via the disabling object. With the enabling telegram the configured behaviour is executed at the end of the disabling function. It should be noted that in the combination of the light control with the first function block the enabling must take place via the disabling object of the function block (disabling object of the light control is then not present).

□-| Brightness limiting values (BLV)

Function Brightness limiting values	disabled
	enabled

The device has up to three mutually independent brightness limiting values that are continuously compared with the brightness value detected. If a limiting value configured in the ETS or predefined externally is exceeded or fallen below, the device can transmit switching, brightness value or scene recall telegrams to the bus and thus trigger appropriate reactions in other bus subscribers. The "Function brightness limiting values" must be enabled here so that the function can be configured and used.

□-| BLV - General

Number of limiting values to be controlled	1 (Output 1) 2 (Output 1, 2) 3 (Output 1, 2, 3)	Up to three limiting values can be evaluated. Each limiting value has its own output object. This parameter defines how many limiting values and thus how many output objects are configurable in the ETS.
The following parameters are available separately for each limiting value (1...3)...		
Limiting value definition	Limiting value is upper threshold Limiting value is lower threshold	A brightness limiting value to be monitored always consists of an upper and lower brightness threshold. The brightness thresholds are assigned via a limiting value and hysteresis derived relatively from the limiting value. The type of limiting value (upper or lower threshold) must be preset accordingly here. Example of the limiting value definition: 1. Brightness limiting value = Upper threshold -> Lower threshold = Brightness limiting value - Hysteresis 2. Brightness limiting value = Upper threshold -> Lower threshold = Brightness limiting value + Hysteresis
Hysteresis (upper threshold)	+1 %... +10 % ...+20 % in 1 % increments	If the limiting value is the lower threshold, the upper threshold is defined by the hysteresis configurable here.
Limiting value (10...2,000 Lux) (lower threshold)	10... 1.000 ...2,000	The limiting value (lower threshold) is configured here. This parameter is only visible if the limiting value is the lower threshold.
Limiting value (10...2,000 Lux) (upper threshold)	10... 1,000 ...2,000	The limiting value (upper threshold) is configured here. This parameter is only visible if the limiting value is the upper threshold.
Hysteresis (lower threshold)	-1 %... -10 % ...-20 % in 1 % increments	If the limiting value is the upper threshold, the lower threshold is defined by the hysteresis configurable here.

<p>Overwrite limiting value in device for ETS download ?</p>	<p>yes no</p>	<p>This parameter determines whether an actively set and active limiting value by previous external object presetting or by Teach is overwritten by the limiting value configured in the ETS during ETS programming. If the setting is "yes", the last value preset externally or by Teach and still active is replaced automatically by the ETS presetting. If the setting is "no", the last limiting value preset externally or by Teach still remains active even after ETS programming. If this parameter is set to "no" and no external presetting has been made yet - if provided for in the configuration - via the 2-byte object or by Teach after the first ETS commissioning, the device always works with the ETS configured value. The ETS parameter only becomes invalid within the above configuration after an external presetting or after a Teach.</p>
<p>Object "Limit value extern presetting"</p>	<p>Disabled enabled</p>	<p>The brightness limiting value is reset in the device by transmitting a brightness value to the 2-byte object "Limiting value x external presetting" in accordance with DPT 9.004, which can be enabled by this parameter. The relative hysteresis value configured in the ETS results in a new value for both brightness thresholds depending on the type of limiting value definition. The new limiting value remains unchanged until a new presetting (externally via object or via Teach function). An ETS programming operation resets a limiting value automatically to the ETS presettings if this is provided for in the configuration.</p>
<p>Teach function</p>	<p>Disabled enabled</p>	<p>With the Teach function, the currently measured brightness value is applied instantly by transmitting a corresponding telegram to the 1-bit object "Limiting value x Teach" as a new limiting value. The relative hysteresis value configured in the ETS results in a new value for both brightness thresholds depending on the type of limiting value definition. The Teach object is configurable if this parameter is set to "enabled".</p>
<p>Teach operating mode</p>	<p>0 = inactive / 1 = active 0 = active / 1 = inactive 0 = active / 1 = active</p>	<p>The polarity of a Teach telegram is configurable by this parameter. Depending on the configuration, it is possible to reset to the configured limiting value upon receiving the opposite object value (Teach inactive).</p>

		<p>The limiting value previously learned will be lost in the process. If, however, the Teach polarity is configured to "1"- and "0"-active, it is not possible anymore to reset to the configured limiting value via this object during ongoing operation of the device!</p> <p>This parameter is visible only if the teach function is enabled.</p>
Feedback "limiting value effective" ?	<p>yes</p> <p>no</p>	<p>The 2-byte objects "limiting value x effective" can be used for the feedback of the limiting values evaluated by the device. The feedback object of a limiting value can be configured if this parameter is set to "yes".</p>
Effect of the feedback	<p>active signalling object</p> <p>passive status object</p>	<p>The feedback of the effective limiting value can optionally take place actively as well as passively (object is readable). In the function as an active signalling object, the current value is transmitted once automatically to the bus on each change of the brightness limiting value, after ETS programming or after bus voltage return (optionally delayed).</p>
Function	<p>Switching</p> <p>Brightness value</p> <p>Scene extension</p>	<p>Each output of a limiting value can be configured to a specific data format independently by this parameter.</p> <p>1-bit switching telegrams (ON / OFF) can be output.</p> <p>It is possible to output 1-byte brightness value telegrams (0...100 %).</p> <p>It is possible to execute a 1-byte scene recall (0...64) in another bus subscriber via the output object of a limiting value.</p>
Transmit telegram on exceeding the upper threshold?	<p>yes</p> <p>no</p>	<p>Depending on the configuration, a limiting value output can transmit a telegram if the brightness value exceeds the upper threshold and/or falls below the lower threshold. This parameter defines whether the corresponding channel output should transmit a telegram on exceeding the upper threshold.</p>
Telegram on exceeding the upper threshold	<p>ON telegram</p> <p>OFF telegram</p>	<p>This parameter defines the switching command, which is transmitted to the bus on exceeding the upper threshold. The parameter is only visible if the function of the limiting value is</p>

		configured to "switching" and a telegram should be transmitted on exceeding the upper threshold.
Telegram on exceeding the upper threshold (0...100 %)	0...100	This parameter defines the brightness value, which is transmitted to the bus on exceeding the upper threshold. The parameter is only visible if the function of the limiting value is configured to "brightness value" and a telegram should be transmitted on exceeding the upper threshold.
Telegram on exceeding the upper threshold (1...64)	1...64	This parameter defines the scene number for the scene recall command, which is transmitted to the bus on exceeding the upper threshold. The parameter is only visible if the function of the limiting value is configured to "scene extension" and a telegram should be transmitted on exceeding the upper threshold.
Transmit telegram on falling below the lower threshold?	yes no	Depending on the configuration, a limiting value output can transmit a telegram if the brightness value exceeds the upper threshold and/or falls below the lower threshold. This parameter defines whether the corresponding channel output should transmit a telegram on not reaching the lower threshold.
Telegram on not reaching lower threshold	ON telegram OFF telegram	This parameter defines the switching command, which is transmitted to the bus on not reaching the lower threshold. The parameter is only visible if the function of the limiting value is configured to "switching" and a telegram should be transmitted on not reaching the lower threshold.
Telegram on not reaching lower threshold (0...100 %)	0...100	This parameter defines the brightness value, which is transmitted to the bus on not reaching the lower threshold. The parameter is only visible if the function of the limiting value is configured to "brightness value" and a telegram should be transmitted on not reaching the lower threshold.
Telegram on not reaching lower	1...64	This parameter defines the scene number for the scene recall command,

threshold (1...64)		which is transmitted to the bus on not reaching the lower threshold. The parameter is only visible if the function of the limiting value is configured to "scene extension" and a telegram should be transmitted on not reaching the lower threshold.
<input type="checkbox"/> BLV - Disable		
Use disabling function ?	yes no	The limiting value evaluation can be disabled independently of the other functional units via the disabling function. A disabled limiting value evaluation is deactivated. No telegrams are then transmitted anymore via the output objects. The presetting of new brightness limiting values by an external brightness value or by the Teach function is not influenced by the disabling function, however. The disabling function can be used if this parameter is configured to "yes". The disabling function is then activated and deactivated via the object "BLV - Disable input".
Polarity of disable object	0 = enable / 1 = disable 0 = disable / 1 = enable	This parameter defines the telegram polarity of the disabling object. The parameter is only visible if the disabling function is enabled.
State of the disabling function after bus voltage return	Deactivated Activated state as before bus voltage failure	The state of the disabling function after bus voltage return can be configured here. The parameter is only visible if the disabling function is enabled. After bus voltage return, the brightness limiting values are ready for operation immediately. The configured thresholds for each output are compared with the current brightness value and evaluated. If the brightness value exceeds or does not reach the corresponding thresholds, the configured telegrams are transmitted. After bus voltage return, all brightness limiting values are disabled. The configured thresholds are not evaluated with the current brightness value. Thus, no telegram is transmitted via any output. If the device detects a bus voltage failure, it saves the current state of the disabling function. After bus voltage

State of the disabling
function after ETS
programming

Deactivated

return, the disabling function adopts the saved state again (active or inactive).

The state of the disabling function after ETS programming is configurable here. The parameter is only visible if the disabling function is enabled.

Activated

After ETS programming, the brightness limiting values are ready for operation immediately. The configured thresholds for each output are compared with the current brightness value and evaluated. If the brightness value exceeds or does not reach the corresponding thresholds, the configured telegrams are transmitted.

After ETS programming, all brightness limiting values are disabled. The configured thresholds are not evaluated with the current brightness value. Thus, no telegram is transmitted via any output.

5 Appendix

5.1 Index

A

application program..... 12

B

brightness limiting values.....60

Brightness measurement.....30

brightness range..... 52

brightness sensor..... 30

brightness setpoint.....37

C

Calibration function..... 30

communication objects..... 18

Control operation..... 34

D

darkness value.....52

E

ETS17

ETS search paths..... 15

L

lower control output limit.....48-49

M

Main control phase..... 48

maximum illuminance..... 52

P

physical address..... 12

R

reflection coefficient..... 30

S

Setpoint shift..... 38

Startup control phase.....45

Superimposed operation.....56

switch-off brightness.....48-49

T

Teach..... 39,62

Gira
Giersiepen GmbH & Co. KG
Elektro-Installations-
Systeme

Industriegebiet Mermbach
Dahlienstraße
42477 Radevormwald

Postfach 12 20
42461 Radevormwald

Deutschland

Tel +49(0)21 95 - 602-0
Fax +49(0)21 95 - 602-191

www.gira.de
info@gira.de