

KNX energy meter Comfort

(Order No. 2173 00 – Direct connection
2175 00 – Transformer connection)



Table of content

Table of content	2
1 Product definition	4
1.1 Product catalogue	4
1.2 Application	4
1.3 System information	4
1.4 Product features	5
2 Installation, electrical connection and operation	6
2.1 General safety instructions	6
2.2 Device description	7
2.3 Mounting and electrical connection	8
2.3.1 Upper connection terminals (2173 00 and 2175 00)	8
2.3.2 Lower connection terminals (2173 00)	9
2.3.3 Lower connection terminals (2175 00)	9
2.3.4 Alternative connections	10
2.4 Tariff assignement	11
2.4.1 Start of the measurement period	11
2.5 Behaviour in case of failure	12
2.5.1 Behaviour in case of failure or loss of mains voltage	12
2.5.2 Behaviour in case of connected mains voltage and failure of the bus voltage	12
2.5.3 Behaviour when the bus voltage has been restored for connected mains voltage	12
2.6 Start-up	13
2.6.1 Programming the physical address of the module	13
2.6.2 Programming the application programme and configuration data	13
2.7 Exchange meter	13
3 Display and Menu structure	14
3.1.1 Drehfeldanzeige	Fehler! Textmarke nicht definiert.
3.1.2 Energy direction	14
3.2 Menu structure	14
3.3 Menu items and sub-menus	16
3.4 Settings using the service button	17
3.4.1 Setting the date	17
3.4.2 Setting the time	17
3.4.3 Changing the transformer ratio (for 2175 00 only)	17
3.4.4 Changing the measurement period	17
3.4.5 Changing the S0 pulse	18
3.4.6 Changing the S0 pulse lenght	18
3.4.7 Configuring the switch outputs	18
3.4.8 Configure the threshold value	19
3.4.9 Change language	19
3.4.10 Resets	20
4 Technical Data	21
5 Metering principal	22

5.1	Definition of the quadrants	22
6	Software description	23
6.1	Software specification.....	23
6.2	KNX energy meter Comfort software	24
6.2.1	Range of functions	24
6.2.2	Information on the software.....	25
6.2.3	Information on the communication objects	25
6.2.1	Object table	26
6.2.2	Functional description.....	43
6.2.3	State of delivery	44
6.2.4	Parameters	45
	Status and S/N	45
	Meter values active energy A+.....	45
	Meter differences	46
	Relative counter	46
	Meter values active energy A-.....	47
	Meter values for reactive energy R+	47
	Meter values for reactive energy R-	48
	Current rate	48
	Effective output P+	49
	Limit value monitoring Effective output P+ (Total, L1, L2, L3)	50
	Effective output P-.....	51
	Effective output P-.....	51
	Limit value monitoring Effective output P- (Total, L1, L2, L3)	52
	Reactive power Q+.....	52
	Reactive power Q-.....	53
	Voltage U	53
	Electricity I.....	53
	Power factor PF.....	54
	Switch outputs	54
7	Error messages.....	55
8	Maintenance.....	56
9	Warranty	56

1 Product definition

1.1 Product catalogue

Product name: Gira KNX energy meter Comfort

Application: KNX energy detection

Design: For installation

Order No.: 2173 00; 2175 00

1.2 Application

The **Gira KNX energy meter** allows measured values to be called up both directly on the device display and via the KNX bus.

The multi-functional KNX energy meter comfort unites the functions of a multimeter and an energy meter. Thus the KNX energy meter achieves excellent flexibility and precision.

The KNX energy meter is used to measure electrical measured values only.

1.3 System information

This device is a product of the KNX system and complies with the KNX guidelines. Detailed specialist knowledge gained in KNX training courses is assumed for understanding.

Functionality of the device is dependent upon software. Detailed information about software versions, specific ranges of functions, and the software itself can be found in the manufacturer's product database. KNX-certified software is used for the planning, installation and start-up of the device.

The up-to-date product database and technical descriptions are available on our website.

1.4 Product features

2173 00 und 2175 00

- Offset bi-directional meter for active and reactive energy
- Front bi-directional D0 interface for communication
- Four switch outputs which can be used individually (Opto Power MOSFET)
- Tariff changeover (2 or 4 tariffs)
- Threshold values for monitoring the various power values can be parameterised on the device or via ETS
- Accuracy class B
- Data backup via EEPROM
- Can be used in private households and industrial operations
- For mounting on a DIN rail TH35
- Maintenance-free

2173 00

- Direct measurement (75 A)

2175 00

- Transformer measurement (1 and 5 A)
- Transformer factor can be parameterised on the device
- Requires current transformer in accordance with the accuracy class
Suggestion: Company ELEQ, e. g. type TQ40-B, TQ40-C or similar types
- Requires 6 A fuses

2 Installation, electrical connection and operation

2.1 General safety instructions

Electrical devices may only be installed and mounted by a qualified electrician.

In doing so, the applicable accident prevention regulations must be observed.

- Isolate before working on the device and load.
- Take account of all circuit breakers supplying dangerous voltage to the device or load.
- Comply with guidelines and standards valid for SELV circuits for installation and cable routing.

DANGER

Improper electrical installations can result in serious material damage or injuries, e.g. due to fire or an electric shock.

Safe electrical installation can only be guaranteed when performed by qualified professionals from the field of electrical installation technology because they possess the following basic knowledge:

- Connection to installation networks
- Connecting more than one electrical device
- Laying electrical cable indoors and outdoors
- Setup and parameterisation of KNX networks

If these minimum requirements are not fulfilled or disregarded, there is a risk of personal liability for material damage and injury!

2.2 Device description

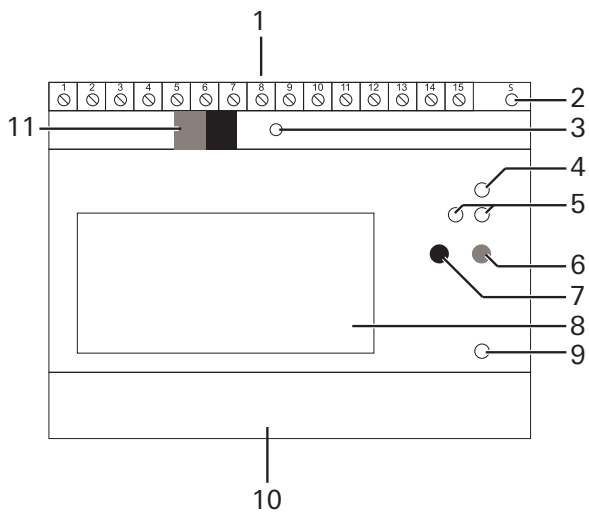

- 1 Connection terminals top
- 2 Button (yellow): Service
- 3 Programming button and LED (green)
- 4 LED: Pulses (10 imp/Wh)
- 5 S0 interface
- 6 Button (red): Select/menu
- 7 Button (blue): Confirm/sub-item
- 8 Display
- 9 LED: Reactive power (10 imp/varh)
- 10 Connection terminals below
- 11 KNX connection

2.3 Mounting and electrical connection

DANGER

Touching live parts can result in serious material damage or injuries, e.g. due to fire or an electric shock.

Isolate before working on the device and cover up live parts in the vicinity.

In case of non-observance, there is a risk of personal liability for material damage and injury!

1. Switch off the mains voltage and secure it against being switched back on.
2. Insert the device on the top-hat rail.
3. Connect the KNX bus via the KNX connection terminal (11).
4. Connect all inputs and outputs according to the application you have chosen.

2.3.1 Upper connection terminals (2173 00 and 2175 00)

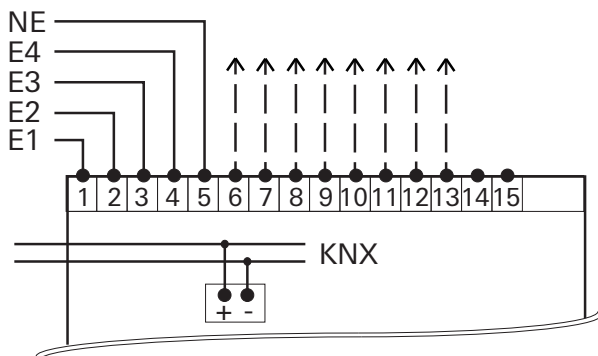

Terminal Configuration

1 / 2	Synchronisation signal for measurement period
3 / 4	Tariff changeover (AC 230 V)
5	Tariff changeover (N)
6 / 7	Switch output 1
8 / 9	Switch output 2
10 / 13	Switch output 3
12 / 13	Switch output 4
14 / 15	Reserve

Switch outputs

The 4 switch outputs can be used as follows:

- as an electronic KNX switch output (configuration via ETS)
- as an S0 pulse output in accordance with EN 62053-21 (configuration using device buttons)
- as a switching threshold (configuration via ETS / device buttons)

The 4 switch outputs are factory preassigned as follows:

- S0 1: Active energy import (kWh)
- S0 2: Reactive energy import (kvarh)
- S0 3: Active energy export (kWh)
- S0 4: Reactive energy export (kvarh)

2.3.2 Lower connection terminals (2173 00)

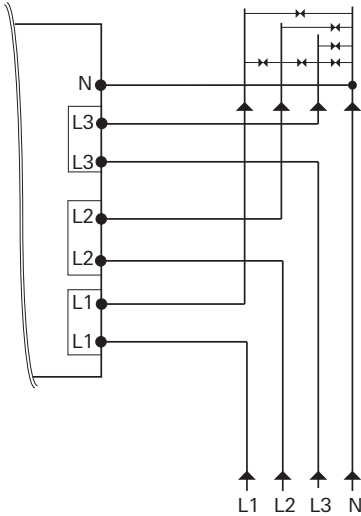

2.3.3 Lower connection terminals (2175 00)

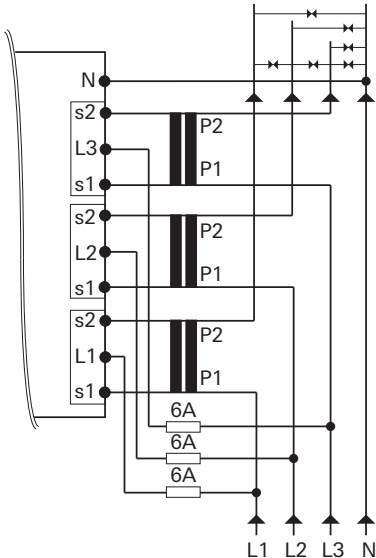

5. Switch on the mains voltage. Following an initialisation phase of several seconds, first the display test appears in the **[Display test]** and then the **[Language selection]**.
6. Select the user language (German or English) via the blue button (7). After approx. 5 s the selected language is automatically applied, and the standard screen with the setting **[Active Energy import]** appears.
7. Switch on the bus voltage.
8. Switch on the mains voltage.

NOTICE: Inspect the following prior to start-up:

- Rotating field direction
- Electricity/phase (negative energy direction)
- Sequence of the phase (L1, L2, L3)
- Transformer ratio
- Terminals

2.3.4 Alternative connections

Single-phase (2173 00)

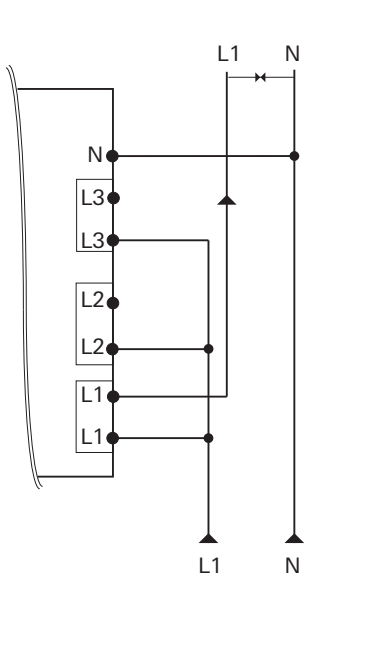

2-phase (2175 00)

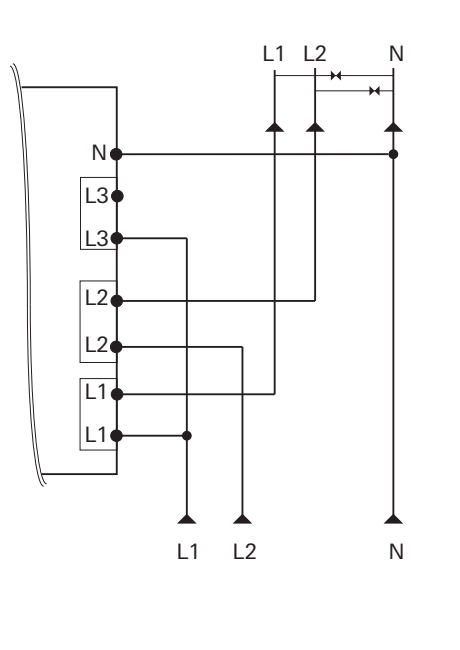

3-phase without N (2173 00)

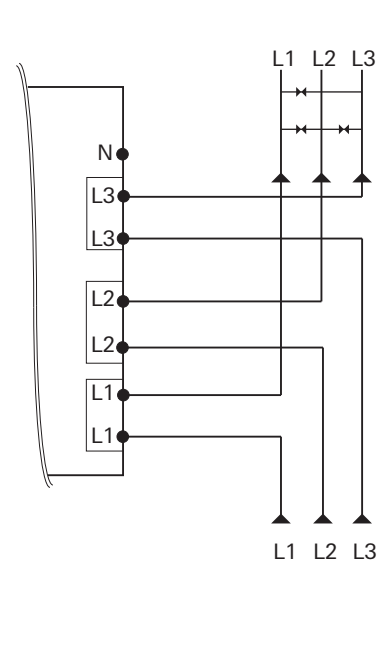

Single-phase (2173 00)
00)

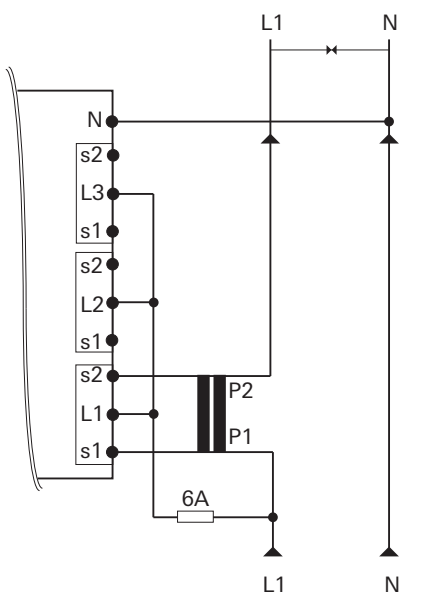

2-phase (2175 00)

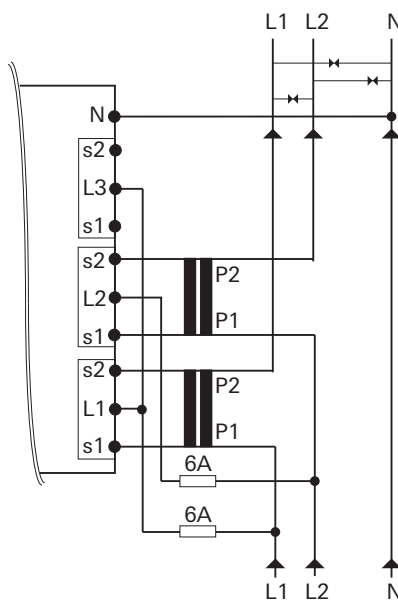

3-phase without N (2175

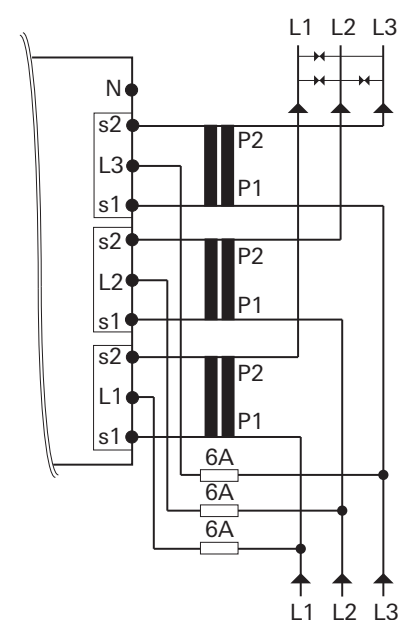

HINWEIS: Measuring accuracy

Observe the following:

In "single-phase", "2-phase", or "3-phase without a neutral conductor (N)" connections, the measuring accuracy no longer complies with accuracy class B.

2.4 Tariff assignement

The tariff is changed over using AC 230 V at the corresponding terminal.

2 tariffs	E4
T1	0
T2	1

4 tariffs	E4	E3
T1	0	0
T2	1	0
T3	0	1
T4	1	1

0 = De-energized / 1 = Voltage

2.4.1 Start of the measurement period

Independent of the setting configured in the ETS, the measurement period can be triggered via an AC 230 V control signal and shown in the display.

	E1	E2
Normal operation	1	0
Start of the measurement period	0	1

0 = De-energized / 1 = Voltage

NOTICE: For safety reasons, a current change must be performed at both inputs.

2.5 Behaviour in case of failure

2.5.1 Behaviour in case of failure or loss of mains voltage

The status object moves to 0 and is sent via the bus. Accordingly, all meter readings are set to 0 and sent.

The current values such as power, voltage, electricity, and power factor are no longer sent. To prevent data loss, all relevant data are saved in a non-volatile EEPROM.

The measured values can still be read off at the device.

2.5.2 Behaviour in case of connected mains voltage and failure of the bus voltage

No more data can be sent or received via the bus. Otherwise the device functions properly.

2.5.3 Behaviour when the bus voltage has been restored for connected mains voltage

The status object moves to 1 and is sent via the bus. All meter readings and the current values such as power, voltage, electricity, and power factor are sent again.

2.6 Start-up

When the bus line has been connected, the energy meter can be started up.
The following physical address is factory preset

15.15.255

NOTE: For new projects, reprogram the physical address of the energy meter; otherwise more than one device can have the same physical address.

2.6.1 Programming the physical address of the module

Programming is done in the programming environment of the ETS (3.0f, 4.0 or higher). An additional KNX data interface is required for programming.

1. Make sure that the bus voltage is switched on.
2. Press the programming button (2).
3. Programming LED (2) lights up green.
4. Program the physical address using the ETS.

The programming LED goes off when the programming process is completed successfully.

5. Make note of the physical address on the device

2.6.2 Programming the application programme and configuration data

Nach der Programmierung der physikalischen Adressen muss das Applikationsprogramm in das Modul eingespielt werden.

1. Sicherstellen, dass die Busspannung eingeschaltet ist.
2. In der ETS das Gerät entsprechend parametrieren.
3. Das Applikationsprogramm in das Gerät einspielen.
4. Die Inbetriebnahme ist abgeschlossen.

2.7 Exchange meter

DANGER

Touching live parts while exchanging the meter can result in a short circuit or an electric shock causing danger for life and limb.

- De-energize all connected conductors prior to the replacement.
- High voltage can be present at interrupted current transformers. This can be extremely dangerous for people and destroy the current transformer.

In case of non-observance, there is a danger of material damage and injury!

3 Display and Menu structure

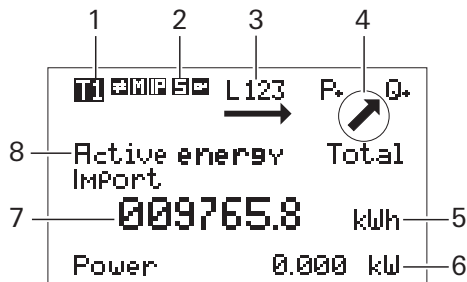

- 1 Active tariff
- 2 Service mode
- 3 Rotating field display
- 4 Energy direction
- 5 Unit
- 6 Current power
- 7 Current meter reading
- 8 Measured value/menu item

3.1.1 Rotating field display

The rotating field display shows the the single phase tension applies. The following notifications are possible:

Display	Meaning
L1	L1 available
L2	L2 available
L3	L3 available
L12	L1 and L2 available
L13	L1 and L3 available
L23	L2 and L3 available
L123	L1, L2 and L3 available
L132	L1, L2 and L3 available, rotation field anticlockwise

3.1.2 Energy direction

The actual energy direction (Active/reactive energy import/export, active/reactive power) measured by the meter is shown in the display. The directional arrow shows in which quadrant the metering is running dependent by the load. Chapter „Metering principal“ on page 22 shows further information to energy directions and quadrants.

Directional arrow	Quadrant/Load
↗	1st Quadrant P+/Q+
↖	2nd Quadrant P-/Q+
↙	3rd Quadrant P-/Q-
↘	4th Quadrant P+/Q-
→	P+/Leerlauf Q
←	P-/Leerlauf Q
↑	Leerlauf P/Q+
↓	Leerlauf P/Q-
-	Leerlauf P/Leerlauf Q

3.2 Menu structure

The following actions can be performed manually via the two buttons on the device:

- Blue button: toggling between the menu items/measured values.
- Red button: activation and toggling of the sub-items for each menu item.

Symbol	Name
	Measured value/menu item
	Measured value/sub-menu
	Next menu item
	Activation/next sub-item

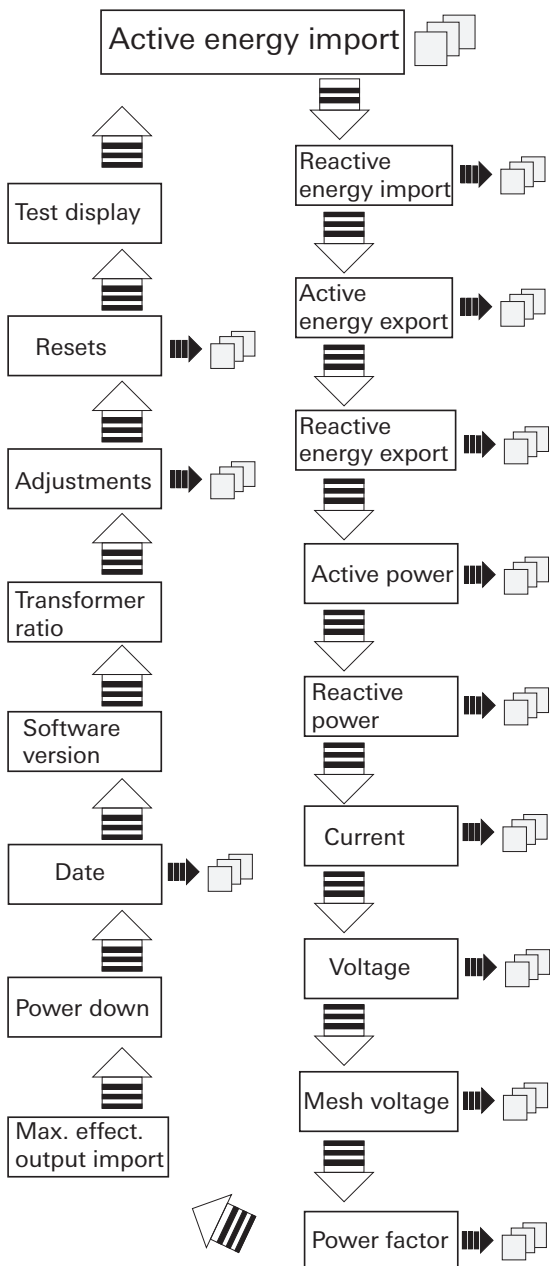

3.3 Menu items and sub-menus

Menu item	Sub-menu
Active energy import	Total Per phase Per tariff
Reactive energy import	Total Per phase Per tariff
Active energy export	Total Per tariff
Reactive energy export	Total Per tariff
Active power	Total Per phase Minimum (total) Minimum per phase Maximum (total) Maximum pro Phase
Reactive power	Total Per phase
Current	Total Per phase Minimum (total) Minimum per phase Maximum (total) Maximum per phase
Voltage	Total Per phase Minimum (total) Minimum per phase Maximum (total) Maximum per phase
Mesh voltage	L1 – L2 L2 – L3 L3 – L4
Power factor	Per phase
Max. effective power import	-
Power down	-
Date	Datem (TT.MM.JJ) Time (hh:mm:ss)
Software version	-
Transformer ratio	For 2175 00 only
Adjustments	Measurement period S0 pulse valency S0 pulse length Assignment of outputs 1 to 4 Language
Resets	Min/Max register Max. effective output Power failure
Display test	All possible symbols and numbers are shown

3.4 Settings using the service button

The settings made using the service button on the device are ETS-independent.

3.4.1 Setting the date

1. Blue button: tap until **[Date]**.
2. Press the service button briefly.
3. Blue button: change number.
4. Red button: swap numbers.
5. Press and hold the service button for 5 s. New value is saved.

3.4.2 Setting the time

1. Blue button: tap until **[Date]**.
2. Red button: tap until **[Time]**.
3. Press the service button briefly.
4. Blue button: change number.
5. Red button: swap numbers.
6. Press and hold the service button for 5 s. New value is saved.

3.4.3 Changing the transformer ratio (for 2175 00 only)

The transformer ratio can be set as follows:

- 5 A transformer: 5 ... 20000
 - 1 A transformer: 1 ... 4000
1. Blue button: tap until **[Transformer ratio]**.
 2. Press the service button briefly.
 3. Blue button: change secondary current.
 4. Red button: change primary current.
 5. Blue button: change first position.
 6. Red button: move ton ext position.
 7. Repeat steps 5 and 6 until all positions have been changed.
 8. Press and hold the service button for 5 s. New value is saved.

3.4.4 Changing the measurement period

1. Blue button: tap until **[ADJUSTMENTS]**.
2. Red button: tap until **[Measurement period]**.
3. Press the service button briefly.
4. Blue button: change time (1 ... 60 min).
5. Press and hold the service button for 5 s. New value is saved.

3.4.5 Changing the S0 pulse

1. Blue button: tap until [ADJUSTMENTS].
2. Red button: tap until [S0 pulse valency].
3. Press the service button briefly.
4. Blue button: Kommastelle (von 0.001 bis 10000) verschieben.
5. Press and hold the service button for 5 s. New value is saved.

3.4.6 Changing the S0 pulse length

1. Blue button: tap until [ADJUSTMENTS].
2. Red button: tap until [S0 pulse length].
3. Press the service button briefly.
4. Blue button: Impulslänge (4 ... 250 ms) in 2 ms Schritten ändern.
5. Press and hold the service button for 5 s. New value is saved.

3.4.7 Configuring the switch outputs

1. Blue button: tap until [ADJUSTMENTS].
2. Red button: tap until [Assignment Output X].
3. Press the service button briefly.
4. Blue button: select among relay output, S0 pulse output (kWh import) and threshold.
5. Press and hold the service button for 5 s. New value is saved.

3.4.8 Configure the threshold value

The following measured values can be selected as a threshold value for each output:

- Effective output
- Reactive power
- Apparent power
- Total electricity
- Electricity per phase

The factory setting for the threshold is 5000 kW and the status is set to "inactive". The address time (= time until the contact switches) and the release time (= time which the contact switches after falling below the threshold) can be set between 0 ... 9999 s.

1. Blue button: tap until **[ADJUSTMENTS]**.
2. Red button: tap until **[Threshold value]**.
3. Blue button: select unit.
4. Red button: continue tapping.
5. Blue button: set threshold value.
6. Red button: select next number.
7. Press and hold the service button for 5 s. New value is saved.
8. Red button: tap until **[Threshold value time on]**.
9. Press the service button briefly.
10. Blue button: change number.
11. Red button: swap numbers.
12. Press and hold the service button for 5 s. New value is saved.
13. Red button: tap until **[Threshold value time off]**.
14. Press the service button briefly.
15. Blue button: change number.
16. Red button: swap numbers.
17. Press and hold the service button for 5 s. New value is saved.

3.4.9 Change language

1. Blue button: tap until **[ADJUSTMENTS]**.
2. Red button: tap until **[Language]**.
3. Press the service button briefly.
4. Blue button: change language (German -> English).
5. Press and hold the service button for 5 s. New value is saved.

3.4.10 Resets

1. Blue button: tap until [RESETS].
2. Red button: select among min/max register, Max. effective output and power failures.
3. Press the service button briefly.
4. Blue button: RESET auswählen.
5. Press and hold the service button for 5 s. Reset was performed for the selected value.

NOTICE: After starting up the device, the service button should be sealed to prevent manipulation to the device .

4 Technical Data

Order No.. 2173 00 and 2175 00

Rated voltage:	3x AC 230/400 V ($\pm 20\%$)
Frequency:	50 – 60 Hz
Power consumption:	< 10 W
Internal consumption:	< 0,6 W/phase

KNX

Power supply:	via KNX bus
Medium:	TP
Start-up mode:	S mode (ETS)
Rated voltage:	DC 21 ... 32 V SELV
Anschluss KNX:	Bus-Anschlussklemme
Betriebstemperatur KNX-BCU:	-5 °C ... +45 °C

Inputs

Input voltage:	AC 230 V
Accuracy class:	Klasse B ($\pm 1\%$) for active energy in accordance to EN 50470-1
DO- interface:	fulfils EN 62056-21

Outputs

Quantity:	4
Type:	Opto Power MOSFET, AC/DC 5 ... 400 V, max. 90 mA

Ambient temperature

Device:	-25 ... +55 °C
KNX-BCU:	-5 ... +45 °C

Housing

Installation width	91 mm
Installation height	90 mm
Installation depth	68 mm
Type of protection	IP20
Compliance	KNX, CE

Order No. 2173 00

Measurement range:	75 A
Starting current:	< 9 mA
Top terminals:	Up to 2,5 mm ² , 0,5 Nm
Bottom terminals:	0,5 ... 35 mm ² , 1,6 Nm

Order No. 2173 00

Measurement range:	1 A / 5 A
Starting current:	< 1 mA
External fuse:	6 A per phase
Top terminals:	Up to 2,5 mm ² , 0,4 Nm
Bottom terminals:	0,5 ... 6 mm ² , 1,6 Nm

5 Metering principal

The metering of the electrical energy occurs by processing the samples that are send by the ADCs (Analog to digital converter) to the processor. Thereby all metering values can be measured respectively calculated for all quadrants.

werden.

5.1 Definition of the quadrants

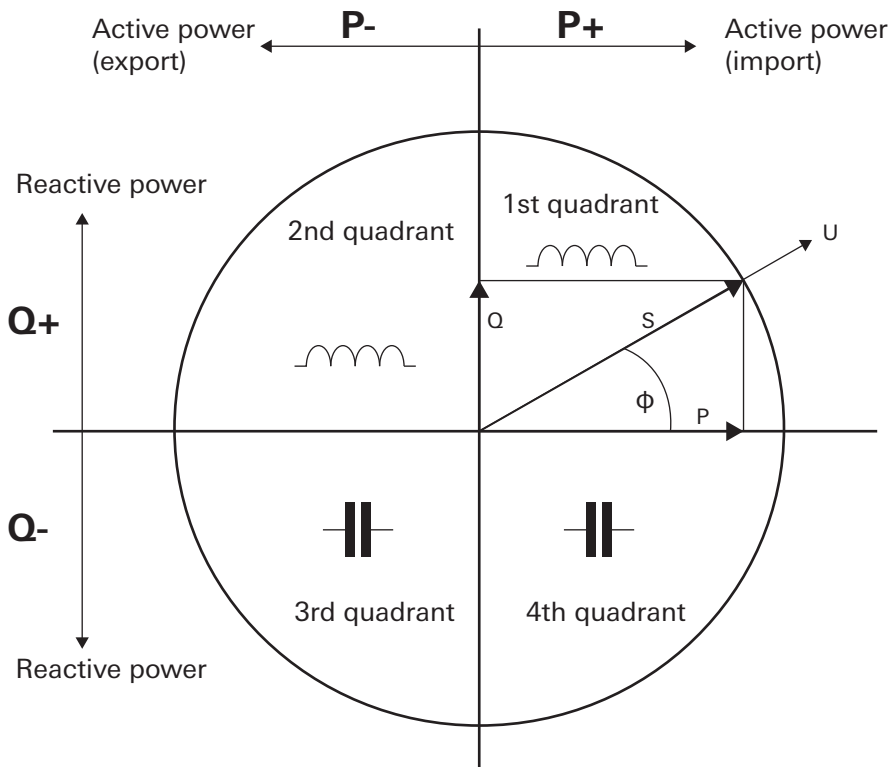

The following energy directions are consequential:

Energy direction	Quadrant
	1st quadrant
	2nd quadrant
	3rd quadrant
	4th quadrant

6 Software description

6.1 Software specification

ETS search paths: Energy management

Configuration:: S-mode standard

Applications:

	Brief description	Name	Version
1	The application is used to parameterise the reception and transmission of data via the KNX bus.	KNX energy meter Comfort B 40110	1.0

6.2 KNX energy meter Comfort software

6.2.1 Range of functions

- Output of the meter reading and serial number
- Output of the *active energy incoming total*, phases L1 to L3 separately as well as the *total active energy incoming* in the individual rates R1 to R4. All data are output either in [Wh] or [kWh].
- Output of the differential count for *active energy incoming* output at 15 min / 60 min interval. The data are output in [Wh].
- Output as a *relative forward counter* for active energy with output of the current meter value and reset function to value of zero. The data are output in [kWh].
- Output as a *relative backward counter* for active energy with output of the current meter value and reset function to a fixed value and a message when the counter expires (value of zero). The data are output in [kWh].
- Output of the *active energy feedback total* as well as in the individual rates R1 to R4. All data are output either in [Wh] or [kWh].
- Output of the *reactive energy inductive total* as well as in the individual rates R1 to R4. All data are output either in [varh] or [kvarh].
- Output of the *reactive energy capacitive total* as well as in the individual rates R1 to R4. All data are output either in [varh] or [kvarh].
- Output of the current rate information or the rate number for up to 4 rates.
- Output of the *effective output incoming total* as well as in the individual phases L1 to L3. The data are output in [W]. With limit value monitoring for total active energy and the active energy in the individual phases L1 to L3. Upper and lower limit value can be parameterised.
- Output of the *effective output feedback total* as well as in the individual phases L1 to L3. The data are output in [W]. With limit value monitoring for total active energy and the active energy in the individual phases L1 to L3. Upper and lower limit value can be parameterised.
- Output of the *reactive power inductive total* as well as in the individual phases L1 to L3. The data are output in [var].
- Output of the *reactive power capacitive total* as well as in the individual phases L1 to L3. The data are output in [var].
- Output of the *voltage values* L1-N, L2-N, L3-N or the *phase-to-phase voltages* L1-L2, L2-L3 and L3-L1. The data are output in [V].
- Output of the *amperage* in the individual phases L1, L2, L3. The data are output in [A].
- Output of the *power factors* in the individual phases L1, L2, L3. The data are output in [cosPhi].
- Control of up to 4 switch outputs.

6.2.2 Information on the software

- The Gira KNX energy meter can be parameterised for ETS 3.0f or higher.

6.2.3 Information on the communication objects

KNX			HomeServer
DPT	Bit/Byte		DatenType
1.001	1-bit	DPT_Switch	1-Bit Switch/Jal (0 ... 1/EIS 1,2,7)
5.010	1 Byte	DPT_Value_1_Ucount	8-Bit (0 ... 255/EIS 2,6)
12.001	4-byte	DPT_Value_4_Ucount	32-Bit (0..4294967295/EIS 11)
13.010	4-byte	DPT_ActiveEnergy	32-Bit (-2147483647 ... 2147483647/EIS 11)
13.013	4-byte	DPT_ActiveEnergy_kWh	32-Bit (-2147483647 ... 2147483647/EIS 11)
13.012	4-byte	DPT_ReactiveEnergy	32-Bit (-2147483647 ... 2147483647/EIS 11)
13.015	4-byte	DPT_ReactiveEnergy_kVARh	32-Bit (-2147483647 ... 2147483647/EIS 11)
14.056	4-byte	DPT_Value_Power	4-Byte (EIS 9/IEEE-Gleitkomma-Wert)
14.028	4-byte	DPT_Value_Electric_PotentialDifference	4-Byte (EIS 9/IEEE-Gleitkomma-Wert)
14.019	4-byte	DPT_Value_Electric_Current	4-Byte (EIS 9/IEEE-Gleitkomma-Wert)
14.057	4-byte	DPT_Value_Power_Factor	4-Byte (EIS 9/IEEE-Gleitkomma-Wert)

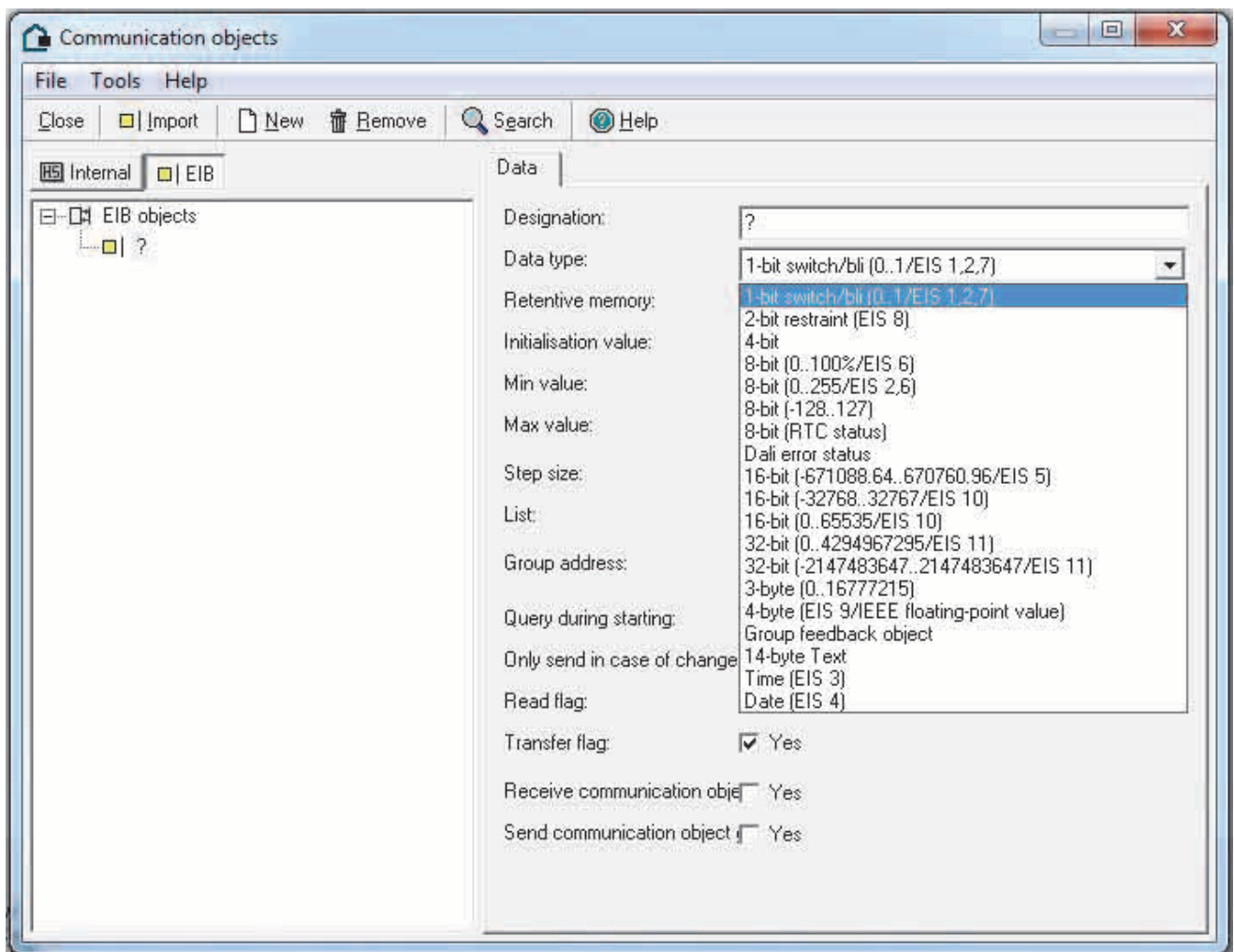

6.2.1 Object table

Number of communication objects:	104
Number of addresses (max):	107
Number of assignments (max):	107
Dynamic table management:	no
Maximum table length:	-

Name: Output

Object	Function	Description	Type	DP type	Flag
 0	Send	Send serial number	4-byte	12.001	C, T
Description:		The serial number of the device is output via the 4-byte object.			

Name: Output

Object	Function	Description	Type	DP type	Flag
 1	Send	Send meter number	4-byte	12.001	C, T
Description:		The meter number of the device is output via the 4-byte object.			

Name: Output

Object	Function	Description	Type	DP type	Flag
 2	Send	Status	1-bit	1.001	C, T
Description:		1-bit object for status transfer. The communication between the BCU and the energy meter can also be defined.			

Name: Input

Object	Function	Description	Type	DP type	Flag
 3	Receive	Meter reading query	1-bit	1.001	C, R, W
Description:		The current meter reading is queried via the 1-bit object.			

Name: Output total

Object	Function	Description	Type	DP type	Flag
 4	Send	Active energy A+ / (Wh)	4-byte	13.013	C, T
Description:		The total active energy incoming can be output in Wh via the 4-byte object.			

Name: Output total

Object	Function	Description	Type	DP type	Flag
 5	Send	Active energy A+ (kWh)	4-byte	13.013	C, T

Description: The total active energy incoming can be output in kWh via the 4-byte object.

Name: Output meter difference A+

Object	Function	Description	Type	DP type	Flag
 6	Send	15 min cycle (Wh)	4-byte	13.010	C, T

Description: 4-byte object for transferring the difference of A+ every 15 min. Output value in Wh.

Name: Output meter difference A+

Object	Function	Description	Type	DP type	Flag
 7	Send	60 min cycle (Wh)	4-byte	13.010	C, T

Description: 4-byte object for transferring the difference of A+ every 60 min. Output value in Wh.

Name: Output relative meter

Object	Function	Description	Type	DP type	Flag
 8	Send	Forward counter A+ (kWh)	4-byte	13.013	C, T

Description: 4-byte object for transferring the meter reading counting from 0 kWh.

Name: Output relative meter

Object	Function	Description	Type	DP type	Flag
 9	Receive	Reset forward counter	1-bit	1.001	C, R, T

Description: This 1-bit object is used to reset the relative forward counter A+ back to "0".

Name: Output relative meter

Object	Function	Description	Type	DP type	Flag
 10	Send	Backward counter A+ (kWh)	4-byte	13.013	C, T

Description: 4-byte object for transferring the current meter reading of the backward counter.

Name: Output relative meter

Object	Function	Description	Type	DP type	Flag
 11	Receive	Set backward counter	4-byte	13.013	C, T

Description: This 4-byte object is used to transfer an output value in kWh to the relative backward counter A+. This function regulates current consumption similar to a prepaid mobile phone, and it can be refilled as needed.

Name: Output relative meter

Object	Function	Description	Type	DP type	Flag
 12	Send	Backward counter = Zero	4-byte	13.013	C, T

Description: The 4-byte object is used to send a telegram as soon as the background counter reaches 0 kWh.

Name: Output tariff 1

Object	Function	Description	Type	DP type	Flag
 16	Send	Active energy A+ (kWh)	4-byte	13.013	C, T

Description: The total active energy A+ in tariff 1 can be output in kWh via the 4-byte object.

Name: Output tariff 1

Object	Function	Description	Type	DP type	Flag
 17	Send	Active energy A+ (Wh)	4-byte	13.010	C, T

Description: The total active energy A+ in tariff 1 can be output in Wh via the 4-byte object.

Name: Output tariff 2

Object	Function	Description	Type	DP type	Flag
 18	Send	Active energy A+ (kWh)	4-byte	13.013	C, T

Description: The total active energy A+ in tariff 2 can be output in kWh via the 4-byte object.

Name: Output tariff 2

Object	Function	Description	Type	DP type	Flag
 19	Send	Active energy A+ (Wh)	4-byte	13.010	C, T

Description: The total active energy A+ in tariff 2 can be output in Wh via the 4-byte object.

Name: Output tariff 3

Object	Function	Description	Type	DP type	Flag
 20	Send	Active energy A+ (kWh)	4-byte	13.013	C, T

Description: The total active energy A+ in tariff 3 can be output in kWh via the 4-byte object.

Name: Output tariff 3

Object	Function	Description	Type	DP type	Flag
 21	Send	Active energy A+ (Wh)	4-byte	13.010	C, T

Description: The total active energy A+ in tariff 3 can be output in Wh via the 4-byte object.

Name: Output tariff 4

Object	Function	Description	Type	DP type	Flag
 22	Send	Active energy A+ (kWh)	4-byte	13.013	C, T

Description: The total active energy A+ in tariff 4 can be output in kWh via the 4-byte object.

Name: Output tariff 4

Object	Function	Description	Type	DP type	Flag
 23	Send	Active energy A+ (Wh)	4-byte	13.010	C, T

Description: The total active energy A+ in tariff 4 can be output in Wh via the 4-byte object.

Name: Output L1

Object	Function	Description	Type	DP type	Flag
 24	Send	Active energy A+ (kWh)	4-byte	13.013	C, T

Description: The total active energy A+ in the incoming direction for the phase L1 is output in kWh via the 4-byte object.

Name: Output L1

Object	Function	Description	Type	DP type	Flag
 25	Send	Active energy A+ (Wh)	4-byte	13.010	C, T

Description: The total active energy A+ in the incoming direction for the phase L1 is output in Wh via the 4-byte object.

Name: Output L2

Object	Function	Description	Type	DP type	Flag
 26	Send	Active energy A+ (kWh)	4-byte	13.013	C, T

Description: The total active energy A+ in the incoming direction for the phase L2 is output in kWh via the 4-byte object.

Name: Output L2

Object	Function	Description	Type	DP type	Flag
 27	Send	Active energy A+ (Wh)	4-byte	13.010	C, T

Description: The total active energy A+ in the incoming direction for the phase L2 is output in Wh via the 4-byte object.

Name: Output L3

Object	Function	Description	Type	DP type	Flag
 28	Send	Active energy A+ (kWh)	4-byte	13.013	C, T

Description: The total active energy A+ in the incoming direction for the phase L3 is output in Wh via the 4-byte object.

Name: Output L3

Object	Function	Description	Type	DP type	Flag
 29	Send	Active energy A+ (Wh)	4-byte	13.010	C, T

Description: The total active energy A+ in the incoming direction for the phase L3 is output in Wh via the 4-byte object.

Name: Output total

Object	Function	Description	Type	DP type	Flag
 30	Send	Active energy A- (kWh)	4-byte	13.013	C, T

Description: The total delivered active energy A- can be output in kWh via the 4-byte object.

Name: Output total

Object	Function	Description	Type	DP type	Flag
 31	Send	Active energy A- (Wh)	4-byte	13.010	C, T

Description: The total delivered active energy A- can be output in Wh via the 4-byte object.

Name: Output tariff 1

Object	Function	Description	Type	DP type	Flag
 32	Send	Active energy A- (kWh)	4-byte	13.013	C, T

Description: The active energy A- in tariff 1 in the supply direction can be output in kWh via the 4-byte object.

Name: Output tariff 1

Object	Function	Description	Type	DP type	Flag
 33	Send	Active energy A- (Wh)	4-byte	13.010	C, T

Description: The active energy A- in tariff 1 in the supply direction can be output in Wh via the 4-byte object.

Name: Output tariff 2

Object	Function	Description	Type	DP type	Flag
 34	Send	Active energy A- (kWh)	4-byte	13.013	C, T

Description: The active energy A- in tariff 2 in the supply direction can be output in kWh via the 4-byte object.

Name: Output tariff 2

Object	Function	Description	Type	DP type	Flag
 35	Send	Active energy A- (Wh)	4-byte	13.010	C, T

Description: The active energy A- in tariff 2 in the supply direction can be output in Wh via the 4-byte object.

Name: Output tariff 3

Object	Function	Description	Type	DP type	Flag
 36	Send	Active energy A- (kWh)	4-byte	13.013	C, T

Description: The active energy A- in tariff 3 in the supply direction can be output in kWh via the 4-byte object.

Name: Output tariff 3

Object	Function	Description	Type	DP type	Flag
 37	Send	Active energy A- (Wh)	4-byte	13.010	C, T

Description: The active energy A- in tariff 3 in the supply direction can be output in Wh via the 4-byte object rden.

Name: Output tariff 4

Object	Function	Description	Type	DP type	Flag
 38	Send	Active energy A- (kWh)	4-byte	13.013	C, T

Description: The active energy A- in tariff 4 in the supply direction can be output in kWh via the 4-byte object.

Name: Output tariff 4

Object	Function	Description	Type	DP type	Flag
 39	Send	Active energy A- (Wh)	4-byte	13.010	C, T

Description: The active energy A- in tariff 4 in the supply direction can be output in Wh via the 4-byte object.

Name: Output total

Object	Function	Description	Type	DP type	Flag
 40	Send	Reactive energy R+ (kvarh)	4-byte	13.015	C, T

Description: The total inductive reactive energy can be output in kvarh via the 4-byte object.

Name: Output Gesamt

Object	Function	Description	Type	DP type	Flag
 41	Send	Reactive energy R+ (varh)	4-byte	13.012	C, T

Description: The total inductive reactive energy can be output in varh via the 4-byte object.

Name: Output tariff 1

Object	Function	Description	Type	DP type	Flag
 42	Send	Reactive energy R+ (kvarh)	4-byte	13.015	C, T

Description: The inductive reactive energy in tariff 1 can be output in kvarh via the 4-byte object.

Name: Output tariff 1

Object	Function	Description	Type	DP type	Flag
 43	Send	Reactive energy R+ (varh)	4-byte	13.012	C, T

Description: The inductive reactive energy in tariff 1 can be output in varh via the 4-byte object.

Name: Output tariff 2

Object	Function	Description	Type	DP type	Flag
 44	Send	Reactive energy R+ (kvarh)	4-byte	13.015	C, T

Description: The inductive reactive energy in tariff 2 can be output in kvarh via the 4-byte object.

Name: Output tariff 2

Object	Function	Description	Type	DP type	Flag
 45	Send	Reactive energy R+ (varh)	4-byte	13.012	C, T

Description: The inductive reactive energy in tariff 2 can be output in varh via the 4-byte object.

Name: Output tariff 3

Object	Function	Description	Type	DP type	Flag
 46	Send	Reactive energy R+ (kvarh)	4-byte	13.015	C, T

Description: The inductive reactive energy in tariff 3 can be output in kvarh via the 4-byte object.

Name: Output tariff 3

Object	Function	Description	Type	DP type	Flag
 47	Send	Reactive energy R+ (varh)	4-byte	13.012	C, T

Description: The inductive reactive energy in tariff 3 can be output in varh via the 4-byte object.

Name: Output tariff 4

Object	Function	Description	Type	DP type	Flag
□← 48	Send	Reactive energy R+ (kvarh)	4-byte	13.015	C, T

Description: The inductive reactive energy in tariff 4 can be output in kvarh via the 4-byte object.

Name: Output tariff 4

Object	Function	Description	Type	DP type	Flag
□← 49	Send	Reactive energy R+ (varh)	4-byte	13.012	C, T

Description: The inductive reactive energy in tariff 4 can be output in varh via the 4-byte object.

Name: Output total

Object	Function	Description	Type	DP type	Flag
□← 50	Send	Reactive energy R- (kvarh)	4-byte	13.015	C, T

Description: The total capacitive reactive energy can be output in kvarh via the 4-byte object.

Name: Output total

Object	Function	Description	Type	DP type	Flag
□← 51	Send	Reactive energy R- (varh)	4-byte	13.012	C, T

Description: The total capacitive reactive energy can be output in varh via the 4-byte object.

Name: Output tariff 1

Object	Function	Description	Type	DP type	Flag
□← 52	Send	Reactive energy R- (kvarh)	4-byte	13.015	C, T

Description: The capacitive reactive energy in tariff 1 can be output in kvarh via the 4-byte object.

Name: Output tariff 1

Object	Function	Description	Type	DP type	Flag
□← 53	Send	Reactive energy R- (varh)	4-byte	13.012	C, T

Description: The capacitive reactive energy in tariff 1 can be output in varh via the 4-byte object.

Name: Output tariff 2

Object	Function	Description	Type	DP type	Flag
□← 54	Send	Reactive energy R- (kvarh)	4-byte	13.015	C, T

Description: The capacitive reactive energy in tariff 2 can be output in kvarh via the 4-byte object.

Name: Output tariff 2

Object	Function	Description	Type	DP type	Flag
 55	Send	Reactive energy R-(varh)	4-byte	13.012	C, T

Description: The capacitive reactive energy in tariff 2 can be output in varh via the 4-byte object.

Name: Output tariff 3

Object	Function	Description	Type	DP type	Flag
 56	Send	Reactive energy R-(kvarh)	4-byte	13.015	C, T

Description: The capacitive reactive energy in tariff 3 can be output in kvarh via the 4-byte object.

Name: Output tariff 3

Object	Function	Description	Type	DP type	Flag
 57	Send	Reactive energy R-(varh)	4-byte	13.012	C, T

Description: The capacitive reactive energy in tariff 3 can be output in varh via the 4-byte object.

Name: Output tariff 4

Object	Function	Description	Type	DP type	Flag
 58	Send	Reactive energy R-(kvarh)	4-byte	13.015	C, T

Description: The capacitive reactive energy in tariff 4 can be output in kvarh via the 4-byte object.

Name: Output tariff 4

Object	Function	Description	Type	DP type	Flag
 59	Send	Reactive energy R-(varh)	4-byte	13.012	C, T

Description: The capacitive reactive energy in tariff 4 can be output in varh via the 4-byte object.

Name: Output tariff

Object	Function	Description	Type	DP type	Flag
 60	Send	Tariff 1 or 2/3/4	1-bit	1.001	C, T

Description: The 1-bit object sends a "0" when tariff 1 is active and a „1“ as soon as tariff 2, 3 or 4 is aktive.

Name: Output tariff

Object	Function	Description	Type	DP type	Flag
 61	Send	Tariff number 1 to 4	1 Byte	5.010	C, T

Description: The current tariff number is output via the 1-byte object.

Name: Output total

Object	Function	Description	Type	DP type	Flag
 62	Send	Effective output P+ (W)	4-byte	14.056	C, T

Description: The total effective output is output in W according to the incoming direction via the 4-byte object.

Name: Output total

Object	Function	Description	Type	DP type	Flag
 63	Send	Upper switching point P+	1-bit	1.001	C, T

Description: The 1-bit object is used to send a telegram as soon as the preset upper switching point P+ is exceeded.

Name: Output Gesamt

Object	Function	Description	Type	DP type	Flag
 64	Send	Lower switching point P+	1-bit	1.001	C, T

Description: The 1-bit object is used to send a telegram as soon as the preset lower switching point P+ is fallen below.

Name: Output L1

Object	Function	Description	Type	DP type	Flag
 65	Send	Effective output P+ (W)	4-byte	14.056	C, T

Description: The effective output P+ for the phase L1 is output in W via the 4-byte object.

Name: Output L1

Object	Function	Description	Type	DP type	Flag
 66	Send	Upper switching point P+	1-bit	1.001	C, T

Description: The 1-bit object is used to send a telegram as soon as the preset upper switching point P+ for the phase L1 is exceeded.

Name: Output L1

Object	Function	Description	Type	DP type	Flag
 67	Send	Lower switching point P+	1-bit	1.001	C, T

Description: The 1-bit object is used to send a telegram as soon as the preset lower switching point P+ for the phase L1 is fallen below.

Name: Output L2

Object	Function	Description	Type	DP type	Flag
 68	Send	Effective output P+ (W)	4-byte	14.056	C, T

Description: The total active energy A+ for the phase L2 in the incoming direction can be output in Wh via the 4-byte object.

Name: Output L2

Object	Function	Description	Type	DP type	Flag
 69	Send	Upper switching point P+	1-bit	1.001	C, T

Description: The 1-bit object is used to send a telegram as soon as the preset upper switching point P+ for the phase L1 is exceeded.

Name: Output L2

Object	Function	Description	Type	DP type	Flag
 70	Send	Lower switching point P+	1-bit	1.001	C, T

Description: The 1-bit object is used to send a telegram as soon as the preset lower switching point P+ for the phase L2 is fallen below.

Name: Output L3

Object	Function	Description	Type	DP type	Flag
 71	Send	Effective output P+ (W)	4-byte	14.056	C, T

Description: The total active energy A+ for the phase L3 in the incoming direction can be output in Wh via the 4-byte object.

Name: Output L3

Object	Function	Description	Type	DP type	Flag
 72	Send	Upper switching point P+	1-bit	1.001	C, T

Description: The 1-bit object is used to send a telegram as soon as the preset upper switching point P+ for the phase L3 is exceeded.

Name: Output L3

Object	Function	Description	Type	DP type	Flag
 73	Send	Lower switching point P+	1-bit	1.001	C, T

Description: The 1-bit object is used to send a telegram as soon as the preset lower switching point P+ for the phase L3 is fallen below.

Name: Output Gesamt

Object	Function	Description	Type	DP type	Flag
 74	Send	Effective output P- (W)	4-byte	14.056	C, T

Description: The total active energy P- in the supply direction can be output in W via the 4-byte object.

Name: Output Gesamt

Object	Function	Description	Type	DP type	Flag
 75	Send	Upper switching point P-	1-bit	1.001	C, T

Description: The 1-bit object is used to send a telegram as soon as the preset upper switching point P- is exceeded.

Name: Output Gesamt

Object	Function	Description	Type	DP type	Flag
 76	Send	Lower switching point P-	1-bit	1.001	C, T

Description: The 1-bit object is used to send a telegram as soon as the preset lower switching point P- is fallen below.

Name: Output L1

Object	Function	Description	Type	DP type	Flag
 77	Send	Effective output P- (W)	4-byte	14.056	C, T

Description: The effective output P- for the phase L1 in the supply direction can be output in W via the 4-byte object.

Name: Output L1

Object	Function	Description	Type	DP type	Flag
 78	Send	Upper switching point P-	1-bit	1.001	C, T

Description: The 1-bit object is used to send a telegram as soon as the preset upper switching point P- for the phase L1 is exceeded.

Name: Output L1

Object	Function	Description	Type	DP type	Flag
 79	Send	Lower switching point P-	1-bit	1.001	C, T

Description: The 1-bit object is used to send a telegram as soon as the preset lower switching point P- for the phase L1 is fallen below.

Name: Output L2

Object	Function	Description	Type	DP type	Flag
 80	Send	Effective output P- (W)	4-byte	14.056	C, T

Description: The effective output P- for the phase L2 in the supply direction can be output in W via the 4-byte object.

Name: Output L2

Object	Function	Description	Type	DP type	Flag
 81	Send	Upper switching point P-	1-bit	1.001	C, T

Description: The 1-bit object is used to send a telegram as soon as the preset upper switching point P- for the phase L2 is exceeded.

Name: Output L2

Object	Function	Description	Type	DP type	Flag
 82	Send	Lower switching point P-	1-bit	1.001	C, T

Description: The 1-bit object is used to send a telegram as soon as the preset lower switching point P- for the phase L2 is fallen below.

Name: Output L3

Object	Function	Description	Type	DP type	Flag
 83	Send	Effective output P- (W)	4-byte	14.056	C, T

Description: The effective output P- for the phase L3 in the supply direction can be output in W via the 4-byte object.

Name: Output L3

Object	Function	Description	Type	DP type	Flag
 84	Send	Upper switching point P-	1-bit	1.001	C, T

Description: The 1-bit object is used to send a telegram as soon as the preset upper switching point P- for the phase L3 is exceeded.

Name: Output L3

Object	Function	Description	Type	DP type	Flag
 85	Send	Lower switching point P-	1-bit	1.001	C, T

Description: The 1-bit object is used to send a telegram as soon as the preset lower switching point P- for the phase L3 is fallen below.

Name: Output Gesamt

Object	Function	Description	Type	DP type	Flag
 86	Send	Reactive power Q+ (var)	4-byte	14.056	C, T

Description: The total inductive reactive power Q+ in the supply direction can be output in var via the 4-byte object.

Name: Output L1

Object	Function	Description	Type	DP type	Flag
 87	Send	Reactive power Q+ (var)	4-byte	14.056	C, T

Description: The inductive reactive power Q+ for the phase L1 in the supply direction can be output in var via the 4-byte object..

Name: Output L2

Object	Function	Description	Type	DP type	Flag
 88	Send	Reactive power Q+ (var)	4-byte	14.056	C, T

Description: The inductive reactive power Q+ for the phase L2 in the supply direction can be output in var via the 4-byte object.

Name: Output L3

Object	Function	Description	Type	DP type	Flag
 89	Send	Reactive power Q+ (var)	4-byte	14.056	C, T

Description: The inductive reactive power Q+ for the phase L3 in the supply direction can be output in var via the 4-byte object.

Name: Output total

Object	Function	Description	Type	DP type	Flag
 90	Send	Reactive power Q- (var)	4-byte	14.056	C, T

Description: The total capacitive reactive power Q- in the supply direction can be output in var via the 4-byte object.

Name: Output L1

Object	Function	Description	Type	DP type	Flag
 91	Send	Reactive power Q- (var)	4-byte	14.056	C, T

Description: The capacitive reactive power Q- for the phase L1 in the supply direction can be output in var via the 4-byte object.

Name: Output L2

Object	Function	Description	Type	DP type	Flag
 92	Send	Reactive power Q- (var)	4-byte	14.056	C, T

Description: The capacitive reactive power Q- for the phase L2 in the supply direction can be output in var via the 4-byte object.

Name: Output L3

Object	Function	Description	Type	DP type	Flag
 93	Send	Reactive power Q- (var)	4-byte	14.056	C, T

Description: The capacitive reactive power Q- for the phase L3 in the supply direction can be output in var via the 4-byte object.

Name: Output L1

Object	Function	Description	Type	DP type	Flag
 94	Send	Voltage U (V)	4-byte	14.028	C, T

Description: The voltage U for the phase L1 to phase N is output in V via the 4-byte object.

Name: Output L2

Object	Function	Description	Type	DP type	Flag
 95	Send	Voltage U (V)	4-byte	14.028	C, T

Description: The voltage U for the phase L2 to phase N is output in V via the 4-byte object.

Name: Output L3

Object	Function	Description	Type	DP type	Flag
 96	Send	Voltage U (V)	4-byte	14.028	C, T

Description: The voltage U for the phase L3 to phase N is output in V via the 4-byte object.

Name: Output L1

Object	Function	Description	Type	DP type	Flag
 97	Send	Current I (A)	4-byte	14.019	C, T

Description: The current I for the phase L1 N is output in amperes via the 4-byte object.

Name: Output L2

Object	Function	Description	Type	DP type	Flag
 98	Send	Current I (A)	4-byte	14.019	C, T

Description: The current I for the phase L2 N is output in amperes via the 4-byte object.

Name: Output L3

Object	Function	Description	Type	DP type	Flag
 99	Send	Current I (A)	4-byte	14.019	C, T

Description: The current I for the phase L3 N is output in amperes via the 4-byte object.

Name: Output L1

Object	Function	Description	Type	DP type	Flag
 100	Send	Power factor cos phi	4-byte	14.057	C, T

Description: The power factor cos phi for the phase L1 is output via the 4-byte object.

Name: Output L2

Object	Function	Description	Type	DP type	Flag
 101	Send	Power factor cos phi	4-byte	14.057	C, T

Description: The power factor cos phi for the phase L2 is output via the 4-byte object.

Name: Output L3

Object	Function	Description	Type	DP type	Flag
 102	Send	Power factor cos phi	4-byte	14.057	C, T

Description: The power factor cos phi for the phase L3 is output via the 4-byte object.

NOTICE: First of all the switch outputs must be configured via the device push-buttons. Pure parameterisation via the ETS is possible but ineffective.

Name: Input

Object	Function	Description	Type	DP type	Flag
 103	Receive	Switch output 1 normal	1-bit	1.001	C, W

Description: A switch output is defined via the 1-bit object.

Name: Input

Object	Function	Description	Type	DP type	Flag
 103	Receive	Switch output 1 inverted	1-bit	1.001	C, W

Description: An inverted switch output is defined via the 1-bit object.

Name: Input

Object	Function	Description	Type	DP type	Flag
 104	Receive	Switch output 2 normal	1-bit	1.001	C, W

Description: A switch output is defined via the 1-bit object.

Name: Input

Object	Function	Description	Type	DP type	Flag
 104	Receive	Switch output 2 inverted	1-bit	1.001	C, W

Description: An inverted switch output is defined via the 1-bit object.

Name: Input

Object	Function	Description	Type	DP type	Flag
 105	Receive	Switch output 3 normal	1-bit	1.001	C, W

Description: A switch output is defined via the 1-bit object.

Name: Input

Object	Function	Description	Type	DP type	Flag
 105	Receive	Switch output 3 inverted	1-bit	1.001	C, W

Description: An inverted switch output is defined via the 1-bit object.

Name: Input

Object	Function	Description	Type	DP type	Flag
 106	Receive	Switch output 4 normal	1-bit	1.001	C, W

Description: A switch output is defined via the 1-bit object.

Name: Input

Object	Function	Description	Type	DP type	Flag
 106	Receive	Switch output 4 inverted	1-bit	1.001	C, W

Description: An inverted switch output is defined via the 1-bit object.

6.2.2 Functional description

The following functions can be enabled via the application:

- Meter number / serial number
- Status
- Meter reading query
- Active energy in kWh and Wh
- 15 min and 60 min cycle
- Relative forward and relative backward counter
- Active energy for up to four rates in kWh and Wh
- Reactive energy for up to four rates in kWh and Wh
- Output of the total effective output (including limit value monitoring) and per phase
- Voltage per phase
- Electricity per phase
- Output of the power factor (cos phi) per phase
- Four switching contacts

The individual functions and their settings are explained as part of the functional description.

Factory settings are marked in bold, black (example: Output meter reading **NO** / YES).

The cycle times are factory preset to 300 s.

6.2.3 State of delivery

Physical address	15.15.255
Device name	Gira KNX energy meter comfort

6.2.4 Parameters

Description:	Values:	Comments:
Status and S/N		
Output meter reading	<p>NO</p> <p>YES</p>	<p>This parameter determines whether the status of the meter is output.</p> <p>The meter status is not output.</p> <p>The meter status is output.</p>
Output serial number	<p>NO</p> <p>YES</p>	<p>This parameter determines whether the serial number of the meter is output.</p> <p>The serial number is output.</p> <p>The serial number is not output.</p>
Send meter reading and serial number cyclically	<p>NO</p> <p>YES</p>	<p>This parameter determines whether the meter reading and serial number should be sent, and which transmission cycle should be applied.</p> <p>Meter reading and serial number are not sent cyclically.</p> <p>Meter reading and serial number are sent according to the interval (5 ... 65535 s / 300) selected in the "Cycle time in s" parameter.</p>
Meter values active energy A+		
Output meter values	<p>NO</p> <p>YES</p>	<p>This parameter determines whether the meter values of the active energy A+ should be output in kWh or Wh depending on the incoming direction.</p> <p>The meter values are not output.</p> <p>The meter values are output.</p>
Send meter values	<p>Cyclically</p> <p>In case of value change Cyclically and in case of a value change</p>	<p>This parameter determines whether meter values should be sent.</p> <p>Meter values are sent according to the interval (5 ... 65535 s / 300) set in the "Cycle time in s" parameter.</p> <p>Meter values are only sent in case of change.</p> <p>Meter values are sent according to the interval (5 ... 65535 s) set in the "Cycle time in s" parameter and in case of a value change.</p>

Meter differences

15 min / 60 min cycle	<p>NO</p> <p>YES</p>	<p>This parameter can be used to select a 15 min or 60 min cycle.</p> <p>Frequency is deactivated.</p> <p>Every 15 or 60 min, a telegram is sent containing the current consumption difference (Wh).</p>
-----------------------	------------------------------------	--

Relative counter

Activate relative forward counter	<p>NO</p> <p>YES</p>	<p>This parameter determines whether a relative forward counter should be activated.</p> <p>A counter is not activated.</p> <p>A relative forward counter is activated. The starting value is "0 kWh". The current value can be reset to "0" at any time via a telegram.</p>
Activate relative backward counter	<p>NO</p> <p>YES</p>	<p>This parameter determines whether a relative backward counter should be activated.</p> <p>A counter is not activated.</p> <p>A relative backward counter is activated. The value to be consumed is defined manually and counted down continuously. A 1-bit telegram is sent when 0 kWh is reached. This function is similar to the principle of a prepaid mobile phone where a fixed amount can be credited and used.</p>
Send relative counters	<p>Cyclically</p> <p>In case of value change</p> <p>Cyclically and in case of a value change</p>	<p>This parameter determines whether the relative counters should be sent.</p> <p>Meter values are sent according to the interval (5 ... 65535 s / 300) set in the "Cycle time in s" parameter.</p> <p>Meter values are only sent in case of change.</p> <p>Meter values are sent according to the interval (5 ... 65535 s) set in the "Cycle time in s" parameter and in case of a value change.</p>

Meter values active energy A-

Output meter values	<p>NO</p> <p>YES</p>	<p>This parameter determines whether the meter values of the active energy A- in the incoming direction should be output in kWh or Wh.</p> <p>Meter values are not output.</p> <p>For YES, the two parameter windows "Send meter values" and "Cycle time in s" are activated.</p>
Send meter values	<p>Cyclically</p> <p>In case of value change Cyclically and in case of a value change</p>	<p>Meter values are sent according to the interval (5 ... 65535 s / 300) set in the "Cycle time in s" parameter.</p> <p>Meter values are only sent in case of change.</p> <p>Meter values are sent according to the interval (5 ... 65535 s) set in the "Cycle time in s" parameter and in case of a value change.</p>

Meter values for reactive energy R+

Output meter values	<p>NO</p> <p>YES</p>	<p>This parameter determines whether the meter values of the inductive reactive energy R+ in the incoming direction should be output in kvarh or varh.</p> <p>Meter values are not output.</p> <p>For YES, the two parameter windows "Send meter values" and "Cycle time in s" are activated.</p>
Send meter values	<p>Cyclically</p> <p>In case of value change Cyclically and in case of a value change</p>	<p>Meter values are sent according to the interval (5 ... 65535 s / 300) set in the "Cycle time in s" parameter.</p> <p>Meter values are only sent in case of change.</p> <p>Meter values are sent according to the interval (5 ... 65535 s) set in the "Cycle time in s" parameter and in case of a value change.</p>

Meter values for reactive energy R-

Output meter values	<p>NO YES</p>	<p>This parameter determines whether the meter values of the capacitive reactive energy R- in the incoming direction should be output in kvarh or varh. Meter values are not output. For YES, the two parameter windows "Send meter values" and "Cycle time in s" are activated.</p>
Send meter values	<p>Cyclically</p> <p>In case of value change Cyclically and in case of a value change</p>	<p>Meter values are sent according to the interval (5 ... 65535 s / 300) set in the "Cycle time in s" parameter. Meter values are only sent in case of change. Meter values are sent according to the interval (5 ... 65535 s) set in the "Cycle time in s" parameter and in case of a value change.</p>

Current rate

Output current rate	<p>NO YES</p>	<p>This parameter determines whether the current rate should be output via the communication objects 60 and 61. A current rate is not output. For YES, the two additional parameter windows "Send current rate" and "Cycle time in s" are activated.</p>
Send current rate	<p>Cyclically</p> <p>In case of value change Cyclically and in case of a value change</p>	<p>Meter values are sent according to the interval (5 ... 65535 s / 300) set in the "Cycle time in s" parameter. Meter values are only sent in case of change. Meter values are sent according to the preset interval and in case of a value change.</p>

Effective output P+

Output effective output	<p>NO</p> <p>YES</p>	<p>This parameter determines whether the incoming effective output P+ should be output in W.</p> <p>Effective output is not output.</p> <p>For YES, the parameter "Send effective output cyclically" is activated.</p>
Send effective output cyclically	<p>NO</p> <p>YES</p>	<p>The effective output is not sent cyclically.</p> <p>The effective output is sent according to the interval (5 ... 65535 s / 300) set in the "Cycle time in s" parameter.</p>
Effective output P+ limit value monitoring	<p>NO</p> <p>YES</p>	<p>This parameter determines whether limit value monitoring should be activated for the total effective output.</p> <p>Limit value monitoring is not activated for the total active energy.</p> <p>Limit value monitoring is activated for the total active energy, and a new tab opens. Settings can now be made for the "upper threshold" and "lower threshold".</p>
Effective output P+ L1 limit value monitoring	<p>NO</p> <p>YES</p>	<p>This parameter determines whether limit value monitoring should be activated for the effective output at L1.</p> <p>Limit value monitoring is not activated for the active energy at L1.</p> <p>Limit value monitoring is activated for the active energy at L1, and a new tab opens. Settings can now be made for the "upper threshold" and "lower threshold".</p>
Effective output P+ L2 limit value monitoring	<p>NO</p> <p>YES</p>	<p>This parameter determines whether limit value monitoring should be activated for the effective output at L2.</p> <p>Limit value monitoring is not activated for the active energy at L2.</p> <p>Limit value monitoring is activated for the active energy at L2, and a new tab opens. Settings can now be made for the "upper threshold" and "lower threshold".</p>
Effective output P+ L3 limit value monitoring	<p>NO</p> <p>YES</p>	<p>This parameter determines whether limit value monitoring should be activated for the effective output at L3.</p> <p>Limit value monitoring is not activated for the active energy at L3.</p> <p>Limit value monitoring is activated for the active energy at L3, and a new tab opens. Settings can now be made for the "upper threshold" and "lower threshold".</p>

Limit value monitoring Effective output P+ (Total, L1, L2, L3)

The parameters "At upper threshold, send telegram at", "Upper threshold in W", "At lower threshold, send telegram at", "Lower threshold in W" below are described only once because the parameters are identical for L1, L2, and L3.

At upper threshold, send telegram at

Do not send telegram

> = ON / > OFF

> = OFF / > ON

> = ON

> = OFF

< ON

< OFF

This parameter determines whether a telegram should be sent as soon as the upper limit is exceeded.

A telegram is not sent.

Upper threshold exceeded = ON telegram
and upper threshold fallen below = OFF telegram.

Upper threshold exceeded = OFF telegram
and upper threshold fallen below = ON telegram.

Upper threshold exceeded = ON telegram.

Upper threshold exceeded = OFF telegram.

Upper threshold fallen below = ON telegram.

Upper threshold fallen below = OFF telegram.

Upper threshold in W

The upper threshold can be set
(1...25 000 / **3300**).

At lower threshold, send telegram at

Do not send telegram

> = ON / > OFF

> = OFF / > ON

> = ON

> = OFF

< ON

< OFF

This parameter determines whether a telegram should be sent as soon as the lower limit is fallen below.

A telegram is not sent.

Lower threshold exceeded = ON telegram
and lower threshold fallen below = OFF telegram.

Lower threshold exceeded = OFF telegram
and upper threshold fallen below = ON telegram.

Lower threshold exceeded = ON telegram.

Lower threshold exceeded = OFF telegram.

Lower threshold fallen below = ON telegram.

Upper threshold fallen below = OFF telegram.

Lower threshold in W

The lower threshold can be set
(1...25000 / **2700**).

Effective output P-

Output effective output	<p>NO</p> <p>YES</p>	<p>This parameter determines whether the effective output P- should be output. Effective output is not output. For YES, the parameter "Send effective output cyclically" is activated.</p>
Send effective output cyclically	<p>NO</p> <p>YES</p>	<p>The effective output is not sent cyclically. The effective output is sent according to the interval (5 ... 65535 s / 300) set in the "Cycle time in s" parameter.</p>
Effective output P- limit value monitoring	<p>NO</p> <p>YES</p>	<p>This parameter determines whether limit value monitoring should be activated for the total effective output. Limit value monitoring is not activated for the total active energy. Limit value monitoring is activated for the total active energy, and a new tab opens. Settings can now be made for the "upper threshold" and "lower threshold".</p>
Effective output P- L1 limit value monitoring	<p>NO</p> <p>YES</p>	<p>This parameter determines whether limit value monitoring should be activated for the effective output at L1. Limit value monitoring is not activated for the active energy at L1. Limit value monitoring is activated for the active energy at L1, and a new tab opens. Settings can now be made for the "upper threshold" and "lower threshold".</p>
Effective output P- L2 limit value monitoring	<p>NO</p> <p>YES</p>	<p>This parameter determines whether limit value monitoring should be activated for the effective output at L2. Limit value monitoring is not activated for the active energy at L2. Limit value monitoring is activated for the active energy at L2, and a new tab opens. Settings can now be made for the "upper threshold" and "lower threshold".</p>
Effective output P- L3 limit value monitoring	<p>NO</p> <p>YES</p>	<p>This parameter determines whether limit value monitoring should be activated for the effective output at L3. Limit value monitoring is not activated for the active energy at L3. Limit value monitoring is activated for the active energy at L3, and a new tab opens. Settings can now be made for the "upper threshold" and "lower threshold".</p>

Limit value monitoring Effective output P- (Total, L1, L2, L3)

The parameters "At upper threshold, send telegram at", "Upper threshold in W", "At lower threshold, send telegram at", "Lower threshold in W" below are described only once because the parameters are identical for L1, L2, and L3.

At upper threshold, send telegram at

Do not send telegram

> = ON / > OFF

> = OFF / > ON

> = ON

> = OFF

< ON

< OFF

This parameter determines whether a telegram should be sent as soon as the upper limit is exceeded.

A telegram is not sent.

Upper threshold exceeded = ON telegram
and upper threshold fallen below = OFF telegram.

Upper threshold exceeded = OFF telegram
and upper threshold fallen below = ON telegram.

Upper threshold exceeded = ON telegram.

Upper threshold exceeded = OFF telegram.

Upper threshold fallen below = ON telegram.

Upper threshold fallen below = OFF telegram.

Upper threshold in W

The upper threshold can be set
(1...25000 / **3300**).

At lower threshold, send telegram at

Do not send telegram

> = ON / > OFF

> = OFF / > ON

> = ON

> = OFF

< ON

< OFF

This parameter determines whether a telegram should be sent as soon as the lower limit is fallen below.

A telegram is not sent.

Lower threshold exceeded = ON telegram
and lower threshold fallen below = OFF telegram.

Lower threshold exceeded = OFF telegram
and upper threshold fallen below = ON telegram.

Lower threshold exceeded = ON telegram.

Lower threshold exceeded = OFF telegram.

Lower threshold fallen below = ON telegram.

Upper threshold fallen below = OFF telegram.

Lower threshold in W

The lower threshold can be set
(1...25000 / **2700**).

Reactive power Q+

Output reactive power

NO

YES

This parameter determines whether the inductive reactive power Q+ total and per phase (L1, L2, L3) should be output in varh. Reactive power is not output.

The reactive power is sent according to the interval (5 ... 65535 s / **300**) set in the "Cycle time in s" parameter.

Send reactive power cyclically

NO

The reactive power is not sent cyclically.

	YES	The reactive power is sent according to the preset interval.
Reactive power Q-		
Output reactive power	NO YES	This parameter determines whether the capacitive reactive power Q- total and per phase (L1, L2, L3) should be output in varh. Reactive power is not output. The reactive power is sent according to the interval (5 ... 65535 s / 300) set in the "Cycle time in s" parameter.
Send reactive power cyclically	NO YES	The reactive power is not sent cyclically. The reactive power is sent according to the preset interval.
Voltage U		
Output voltage	NO YES	This parameter determines whether voltage per phase (L1, L2, L3) should be output in V. Voltage is not output. The voltage is sent according to the interval (5 ... 65535 s / 300) set in the "Cycle time in s" parameter.
Send voltage cyclically	NO YES	The voltage is not sent cyclically. The voltage is sent according to the preset interval.
Reference potential		Either voltages L-N or phase-to-phase voltages L-L can be selected here.
Electricity I		
Output electricity	NO YES	This parameter determines whether electricity per phase (L1, L2, L3) should be output in A. Electricity is not output. The electricity is sent according to the interval (5 ... 65535 s / 300) set in the "Cycle time in s" parameter.
Send electricity cyclically	NO YES	The electricity is not sent cyclically. The electricity is sent according to the preset interval.

Power factor PF

Output power factor	NO YES	This parameter determines whether the power factor (cos phi) per phase (L1, L2, L3) should be output. Power factor is not output. The power factor is sent according to the interval (5 ... 65535 s / 300) set in the "Cycle time in s" parameter.
Send power factor cyclically	NO YES	The electricity is not sent cyclically. For YES, the power factor is sent according to the interval (5 ... 65535 s) set in the "Cycle time in s" parameter.

Switch outputs

The four free switch outputs can be configured via these parameters.
Only the settings for switch output 1 are described because the settings are identical for the switch outputs 2 to 4. The following settings can be selected.

Switch output 1	do not use	Switch output 1 is not used.
	Output normal (1 = ON, 0 = OFF)	The behaviour of the output is normal.
	Output inverted (1 = OFF, 0 = ON)	The behaviour of the output is inverted.

NOTE: The switch outputs can also be configured directly on the device (KNX switch output, S0 pulse output, or threshold). These settings do not overwrite the values set in the ETS. Instead, they are KNX-independent.

7 Error messages

In case of an internal error, an error message is shown in the display.

Error code	Meaning
F.F.0(00000000)	No error, meter OK
F.F.0(xxxxxxx0)	Meter official verificated (calibrated)
F.F.0(xxxxxxx1)	Meter not official verificated
F.F.0(xxxxxxx8)	Verification release (Meter official verificated, but it can be recalibrated)
F.F.0(xxxxxxx9)	Verification release (Meter not yet official verificated, can be recalibrated)
F.F.0(xxxxxxxF)	Zähler neu initialisiert (Default-Werte geladen)
F.F.0(xxxxxx0x)	Zähler im Normalmodus
F.F.0(xxxxxx1x)	Zähler im Servicemodus
F.F.0(xxxxx0xx)	Checksum Micro FLASH and EEPROM OK
F.F.0(xxxxx1xx)	Checksum Micro FLASH error
F.F.0(xxxxx2xx)	Checksum EEPROM error
F.F.0(xxxxx3xx)	Checksum Micro FLASH and EEPROM error
F.F.0(xxxx0xxx)	Micro RAM and Micro STACK OK
F.F.0(xxxx1xxx)	Checksumme Micro RAM error
F.F.0(xxxx2xxx)	Fehler Micro STACK (Overflow)
F.F.0(xxxx3xxx)	Fehler Checksumme Micro RAM und Micro STACK
F.F.0(xxx0xxxx)	Micro OK
F.F.0(xxx1xxxx)	Micro error
F.F.0(xx0xxxxx)	Hardware OK
F.F.0(xx1xxxxx)	Hardware error
F.F.0(x0xxxxxx)	Time basis (real time clock) OK
F.F.0(x1xxxxxx)	Time basis error
F.F.0(0xxxxxxx)	Real time clock set
F.F.0(1xxxxxxx)	Real time clock with default values (Date/Time)

8 Maintenance

The device is maintenance free. At damages (e. g. transport, storage) oneself reparation is not allowed.

9 Warranty

NOTICE: The producer guarantee expires at once by damaging or removing the device seals and the device must be recalibrated and seled by an authorised calibration!
The same applies if there is a defect caused by outer impact (e.g. flash, water, fire, extreme temperatures and/or weather conditions, improper use/handling).

The warranty is provided in accordance with statutory requirements via the specialist trade.

Please submit or send faulty devices postage paid together with an error description to your responsible salesperson (specialist trade/installation company/specialist electrical trade).

They will forward the devices to the Gira Service Center.