

Gira G1

230 V 2067 05 / 2067 12

PoE 2069 05 / 2069 12

24 V 2077 05 / 2077 12



[EN] Assembly and
operating instructions
for the installer

Important:

Please read carefully
before use.

Please retain for
future reference.

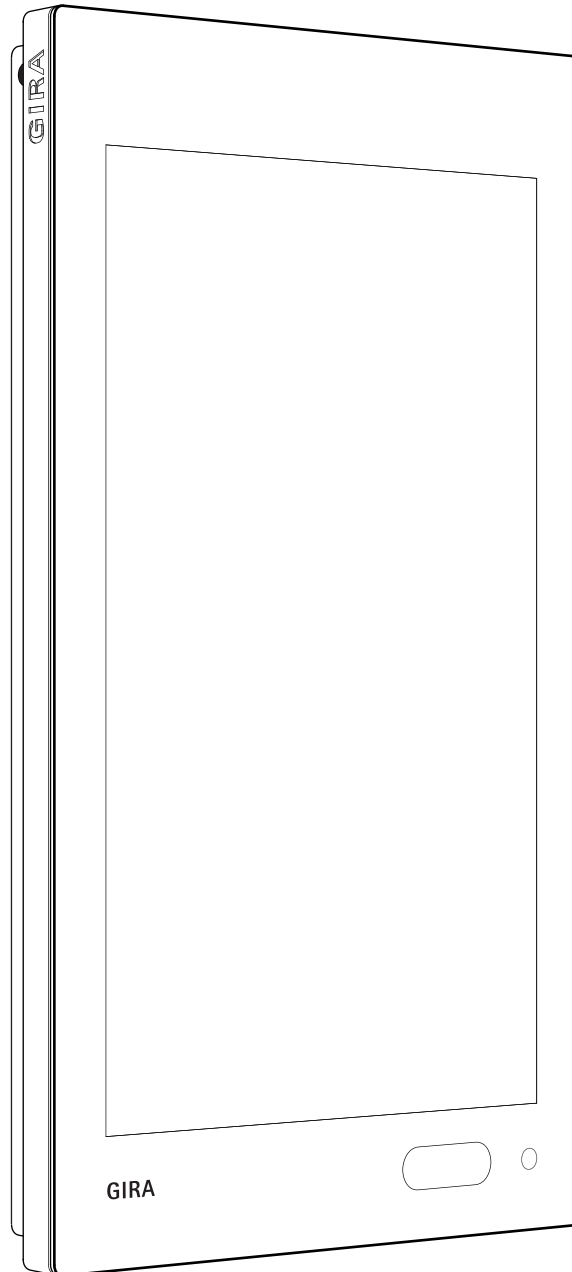

Contents

1	Configuring the Gira G1	p. 2
1.1	Commissioning assistant - selecting the operating mode	p. 2
1.2	System and applications	p. 3
<hr/>		
2	Configuring the Gira G1 (KNX)	p. 4
2.1	Initial commissioning	p. 4
2.2	Configuring KNX devices	p. 5
2.3	KNX functions	p. 6
2.4	PoE topology	p. 7
2.4.1	Gira G1 in main line	p. 7
2.4.2	Gira G1 in area line	p. 9
2.5	WLAN topology	p. 11
2.5.1	Connecting the commissioning PC via KNX IP router (recommended)	p. 11
2.5.2	Connecting the commissioning PC via KNX USB interface	p. 12
<hr/>		
3	Gira G1 (KNX) settings	p. 13
3.1	System menu	p. 14
3.1.1	Select direct function	p. 14
3.1.2	System	p. 15
3.1.3	PIN protection	p. 22
3.1.4	View configuration	p. 23
3.2	Information	p. 26
3.2.1	Gira app version	p. 26
<hr/>		
4	Operating the Gira G1 (KNX)	p. 27
4.1	Structure of the user interface	p. 27
4.2	Status bar	p. 28
4.3	Navigation bar	p. 28
4.4	Action area	p. 29
4.5	Direct function	p. 29
4.6	Tile view	p. 30
4.7	Detail view	p. 31
4.8	Scene auxiliary unit	p. 33
4.9	Room temperature presence button and mode	p. 34
4.10	Timer	p. 35
4.10.1	Creating a switching time	p. 36
4.10.2	Deleting a switching time	p. 37
4.10.3	Activating and deactivating all switching times for a function	p. 37
4.11	Function folder	p. 38
<hr/>		
5	Configuring the Gira X1 Client	p. 39
5.1	Initial commissioning	p. 39
<hr/>		
6	Gira X1 Client settings	p. 40
6.1	System menu	p. 41
6.1.1	Select direct function	p. 41
6.1.2	System	p. 42
6.1.3	PIN protection	p. 48
6.1.4	View configuration	p. 49

6.2	Additional functions	p. 53
6.3	Administrator functions	p. 54
6.3.1	Manage rooms	p. 54
6.3.2	Manage functions	p. 54
6.3.3	Sort rooms/functions	p. 57
6.3.4	Manage subsections	p. 57
6.3.5	Manage users	p. 58
6.4	Information	p. 61
6.4.1	Gira app version	p. 61
<hr/>		
7	Operating the Gira X1 Client	p. 62
7.1	Status bar	p. 62
7.2	Navigation bar	p. 62
7.3	Direct function	p. 63
7.4	Tile view	p. 64
7.5	Detail view	p. 65
7.6	Scene auxiliary unit	p. 67
7.7	Room temperature presence button and mode	p. 68
7.8	Timer	p. 69
7.8.1	Creating a switching time	p. 70
7.8.2	Deleting a switching time	p. 73
7.8.3	Activating and deactivating all switching times for a function	p. 74
7.9	Function folder	p. 75
7.10	Occupancy simulation	p. 75
7.10.1	Recording a simulation	p. 76
7.10.2	Playing a simulation	p. 76
7.11	Timers	p. 77
7.12	Scenes	p. 78
7.13	Sonos audio function	p. 79
7.13.1	Configuring the Sonos audio function	p. 80
7.13.2	Change Sonos loudspeaker	p. 81
7.13.3	Configuration of the favorites	p. 82
7.13.4	How favourites behave after the memory function has been used	p. 83
7.13.5	Which errors may occur?	p. 83
7.14	Philips Hue lights	p. 84
7.15	IoT trigger (IFTTT)	p. 85
7.16	Remote access	p. 86
7.16.1	Remote access in detail view	p. 86
7.16.2	Remote access in tile view	p. 87
<hr/>		
8	Configuration of Gira G1 in the GPA	p. 88
<hr/>		
9	Configuring the Alarm Connect security system	p. 91
9.1	Initial commissioning	p. 91
<hr/>		
10	Alarm Connect security system settings	p. 92
10.1	System menu	p. 93
10.1.1	Select direct function	p. 93
10.1.2	System	p. 94
10.1.3	PIN protection	p. 100
10.1.4	View configuration	p. 101
10.2	Additional functions	p. 104

10.3	Administrator functions	p. 105
10.3.1	Manage rooms	p. 105
10.3.2	Manage functions	p. 105
10.3.3	Sort rooms/functions	p. 107
10.3.4	Manage subsections	p. 107
10.3.5	Manage users	p. 108
10.4	Information	p. 109
10.4.1	Gira app version	p. 109
<hr/>		
11	Operating the Alarm Connect security system	p. 110
11.1	Status bar	p. 110
11.2	Navigation bar	p. 110
11.3	Alarm-specific buttons and displays	p. 110
11.4	Externally activating a security area	p. 111
11.5	Internally activating a security area	p. 112
11.6	Deactivating a security area	p. 112
11.7	Viewing and acknowledging alarms and messages	p. 113
<hr/>		
12	Configuring the Gira HomeServer Client/eNet Client	p. 114
12.1	Initial commissioning	p. 114
12.2	Navigation bar	p. 115
12.3	Settings	p. 116
12.4	Wireless & Networks	p. 116
12.4.1	Configure LAN network	p. 117
12.4.2	Configure WLAN	p. 118
12.4.3	Advanced WLAN settings	p. 120
12.5	Device	p. 121
12.5.1	Set proximity sensor	p. 121
12.5.2	Language & Input	p. 121
12.6	System	p. 122
12.6.1	Date & Time	p. 122
12.6.2	Information	p. 123
12.6.3	Gira app settings	p. 123
12.6.4	Factory reset & restart	p. 123
<hr/>		
13	Configuring the Gira HomeServer app	p. 124
13.1	Initial commissioning of the HomeServer app	p. 124
<hr/>		
14	Operating the Gira HomeServer app	p. 126
14.1	Menu	p. 126
14.2	Favourites	p. 127
14.3	System	p. 128
14.3.1	Profiles	p. 129
14.3.2	Profile settings	p. 130
14.3.3	Configure favourites	p. 131
<hr/>		
15	Configuring the eNet Client	p. 132
15.1	Initial commissioning of the eNet SMART HOME app	p. 132
<hr/>		
16	Configuring door communication	p. 133
16.1	Connecting the Gira G1 to the door communication system	p. 133
16.2	Connecting to the DCS-IP gateway	p. 134
16.2.1	Access data	p. 135

17	Operating door communication	p. 136
17.1	Structure of the user interface	p. 136
17.2	Operating calls	p. 137
17.2.1	Accepting a call	p. 137
17.2.2	Ending a call	p. 137
17.2.3	Resuming a call	p. 138
17.3	Switching the ring tone off	p. 138
17.4	Opening the door	p. 138
17.5	Switching the camera on	p. 138
17.6	Door communication system menu	p. 139
17.6.1	Forwarding	p. 139
17.6.2	Call door station	p. 140
17.6.3	Internal call	p. 140
17.6.4	Selecting a camera	p. 140
17.6.5	Ringtone melody	p. 140
17.6.6	Automatic door opener	p. 141
17.6.7	Access data	p. 141
17.6.8	Voice volume	p. 142
17.6.9	Ring tone volume	p. 142

18	Setting up SIP door communication	p. 143
18.1	Connecting the Gira G1 to a SIP-capable door station	p. 143
18.1.1	Direct connection	p. 143
18.1.2	Connection via SIP server	p. 143

19	Operating SIP door communication	p. 144
19.1	User interface structure	p. 144
19.2	Managing calls	p. 145
19.2.1	Accepting a call	p. 145
19.2.2	Ending a call	p. 145
19.3	Deactivating the ringing tone	p. 145
19.4	Opening the door	p. 146
19.5	Switch on the camera	p. 146
19.6	Door communication system menu	p. 147
19.6.1	Call door station	p. 147
19.6.2	Internal call	p. 147
19.6.3	Camera selection	p. 148
19.6.4	Ringling tone melody	p. 148
19.6.5	Voice volume	p. 148
19.6.6	Ringling tone volume	p. 149
19.6.7	Door opener	p. 149

20	Weather forecast	p. 150
20.1	Configuring the weather forecast	p. 150
20.1.1	Adding a weather station	p. 150
20.1.2	Changing the order of weather stations	p. 151
20.1.3	Deleting a weather station	p. 151
20.2	Reading weather data	p. 152

21	Firmware update	p. 153
21.1	Adding firmware	p. 153
21.1.1	Adding firmware manually	p. 153
21.1.2	Adding firmware automatically	p. 154
21.2	Installing firmware	p. 154

22	Device website	p. 155
22.1	Device information	p. 155
22.2	SIP door communication	p. 156
22.2.1	Import/export settings	p. 156
22.2.2	Setting up a SIP network	p. 157
22.2.3	Outgoing calls	p. 158
22.2.4	Added SIP participants	p. 158
22.2.5	Adding SIP participants	p. 159
22.2.6	Favourites buttons	p. 160
22.3	Diagnosis	p. 161
22.3.1	Restart	p. 161
22.3.2	Factory settings	p. 162
22.3.3	Programming mode	p. 162
22.3.4	Download log files	p. 162
22.3.5	Extended logging	p. 162

23	Appendix	p. 163
23.1	Error messages	p. 163
23.2	Manual device restart via magnet	p. 163
23.3	Anonymous usage statistics	p. 164
23.4	List of available symbols	p. 165
23.5	Gira G1 design	p. 172
23.6	Gira G1 dimensions	p. 173
23.7	PoE connection module terminal assignment	p. 174

24	Warranty	p. 174
----	----------------	--------

1

Configuring the Gira G1

1.1

Commissioning assistant - selecting the operating mode



Note Run update

Before initial commissioning of the Gira G1, check if a firmware update is available for the Gira G1 and carry out the update using the Gira Project Assistant if necessary.

A free version of the Gira Project Assistant can be downloaded at: www.download.gira.de ↗. For more information on firmware updates, see page 153.

The following description requires that you have already updated to firmware version V3.0 or higher.

- 1 Mount the Gira G1 (see Gira G1 mounting instructions).
- ✓ The commissioning program starts automatically when the power supply is switched on.
- 2 A commissioning assistant is displayed on initial set-up of the Gira G1. Follow the instructions on the screen.
- 3 Specify the language setting for the Gira G1.
- 4 Read the license agreement and accept it by scrolling down to the bottom of the page, ticking the box and then tapping [Accept].
- 5 Select your time zone.
- 6 Select the system and the applications that you want to run on the Gira G1. The available systems and applications are listed below.
- 7 Exit the basic configuration by tapping [Start].
- 8 Commissioning of the relevant system begins when you exit the basic configuration. Please read the relevant section to continue set-up.

1.2

System and applications

The Gira G1 can be run in several systems. As of version 3.0, the firmware provides all of the necessary content. You can set the desired operating mode during commissioning. The options are set out below.

- KNX system

In this mode, the Gira G1 is used as a KNX device. Configuration is performed via the ETS.

Please note that the “Door communication” and “Weather forecast” applications must be enabled in the ETS.

For more information on commissioning as a KNX device, [see 2].

- Gira X1 and security system

In this mode, the Gira G1 is used as a Client for the Gira X1 or the Gira Alarm Connect security system. The corresponding devices (Gira X1 and Gira Alarm Connect security system) are configured via the Gira Project Assistant.

You can activate the “Door communication” and “Weather forecast” applications in the Gira G1’s commissioning assistant.

For more information on commissioning as a Client for the Gira X1 or the Gira Alarm Connect security system, [see 5].

- Gira HomeServer/eNet Server

In this mode, the Gira G1 is used as a Client for the Gira HomeServer or the Gira eNet server. See the respective apps for set-up of Clients. You can also activate the “Door communication” and “Weather forecast” applications in the app settings.

For information on commissioning the HomeServer Client, [see 12].

For information on commissioning the eNet Client, [see 14].

- Only use applications

If you wish to use the Gira G1 exclusively as a home station for the Gira door communication system and weather forecast, you can select the option “Only use applications”. You set up the two applications on the Gira G1.

For information on setting up the door communication system, [see 15].

For information on setting up the weather forecast, [see 17].

**Note****Switching off date/time display**

If you only want to operate the Gira G1 as a home station, the wrong time and data information will be shown in the header since this function requires an Internet connection. In this case, you can switch off the date/time display in the system menu.

Configuring the Gira G1 (KNX)

2.1

Initial commissioning

Once you have selected the “KNX system” option in the basic configuration of the Gira G1, proceed as follows with commissioning:

- 1 Exit the basic configuration by tapping "Start".
- ✓ The device starts the commissioning configuration and then goes to system settings.
- 2 In system settings you can check and configure the network settings [see 3.1.2.3] and the network connection type (LAN or WLAN) [see 3.1.2.4].
- 3 Transfer the previously created KNX project to the Gira G1 using the ETS, see "KNX programming mode" [see 3.1.2].
- 4 Please note that you must activate the “Door communication” and “Weather forecast” functions in the parameter settings of the ETS if you wish to use them.
- 5 Enter the access data for the door communication system, if appropriate [see 15.2.1].
- 6 Select the locations for the weather station, as appropriate [see 17.1.1].



Time and date

Time and date are acquired from a time server on the internet (ntp: 0.europe.pool.ntp.org). Alternatively, the date and time can be obtained from the KNX system. A system clock must be present in the KNX system for this purpose (e.g. the Gira KNX IP router).

2.2

Configuring KNX devices

The Gira G1 is a product of the KNX system and complies with the KNX guidelines. Detailed specialist knowledge is required. The Gira G1 can serve as a multifunctional room operating device for an existing or newly installed KNX system.

Initial commissioning is performed via ETS 5.5.4 or higher.

**Note**

You can find the KNX product database and the technical documentation on the internet at www.download.gira.de ↗.

KNX/IP uses Multicast to mirror KNX bus group communication on IP. For coupling the Gira G1 with a twisted pair bus (TP bus) always use a KNX/IP router from any compatible manufacturer.

**Tip****Faster configuration via direct IP connection**

Under "Communication" in ETS settings select the option "Use direct KNX IP connection if available" to speed up the transfer of the KNX project from the ETS to the Gira G1.

**Tip****Configuration via WLAN connection**

The Multicast telegrams used by the KNX system may be lost in WLAN operation.

Should problems occur during ETS programming in WLAN operation via the routing interface of the ETS, please try one of the following solutions:

- Create a tunneling connection via the Gira KNX IP router (Article no. 2167 00, from firmware version 3.0) and program the Gira G1.
- Create a connection with the line/the area "beneath" a Gira KNX IP router (Article no. 2167 00, from firmware version 3.0) via a KNX interface and program the Gira G1.

For both suggested solutions, activate the "Reliable communication" function on the KNX IP router and on the Gira G1.

Reliable communication

2.3

KNX functions

Depending on the installation, the following KNX functions can be performed using the Gira G1:

- Switching
- Dimming (relative and absolute)
- Dimming (RGB, RGBW and Tunable White)
- Blind and shutter control
- Scene auxiliary unit
- Value transmitter
- Status display
- Room temperature controller
- Room temperature controller auxiliary unit
- Room temperature controller auxiliary unit for sauna operation
- Room temperature controller auxiliary unit for controlling air-conditioning systems
(fan coil) combined with a KNX gateway for air-conditioning systems
- Show IP cameras
- URL link
- Audio control (with media data/with playlist)
- Display time and date
- Display indoor and outdoor temperature

The Gira G1 can manage up to 150 functions: 6 function folders or rooms with up to 25 functions each.

For most functions, the Gira G1 offers weekly timers with 10 switching times each. 28 switching times are possible for the room temperature controller and room temperature controller auxiliary unit functions.

Timer

2.4
PoE topology

The Gira G1 is integrated into either the main line or area line of the KNX system via a KNX IP router. For this, the Gira G1 can either be integrated into the main line or area line.

2.4.1
Gira G1 in main line

The following topology illustrates how the Gira G1 is operated in the main line. In this case the KNX IP router is used as a line coupler.

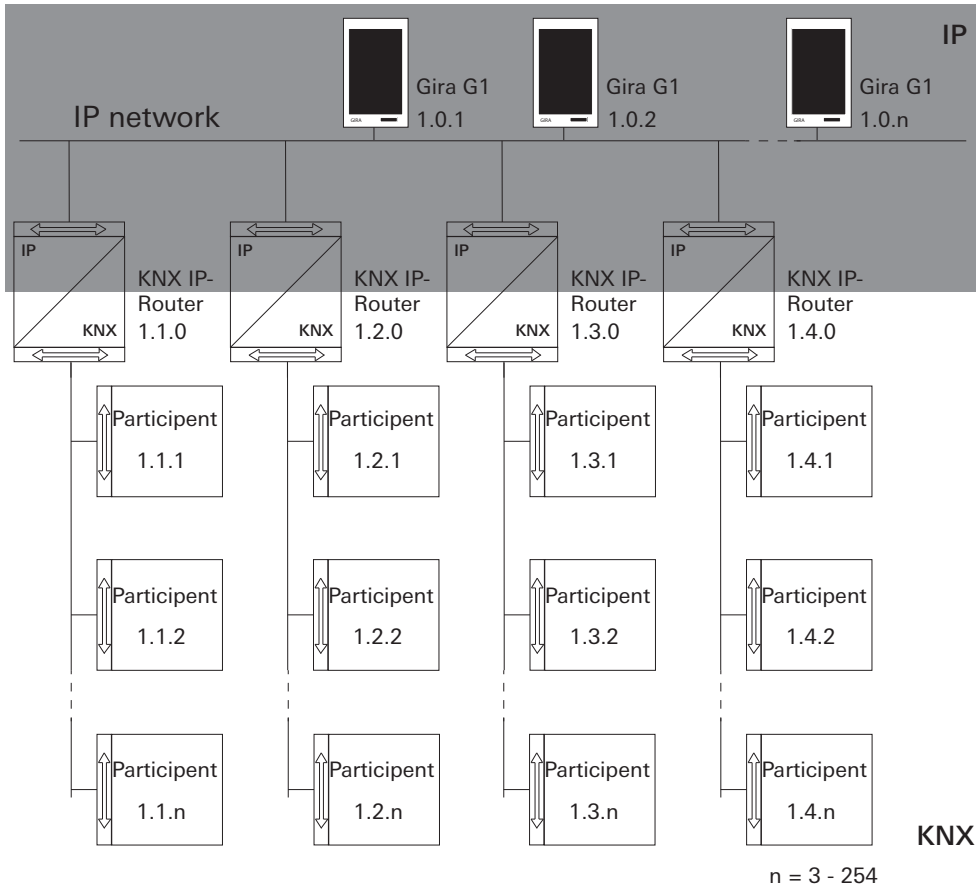
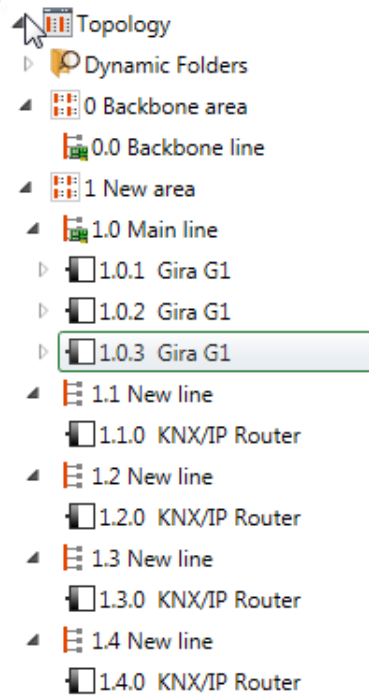

Figure 1
Topology example:
Gira G1 in main line

When installing the Gira G1 in the main line, the configuration in ETS4 or ETS5 would be as follows:

ETS4:

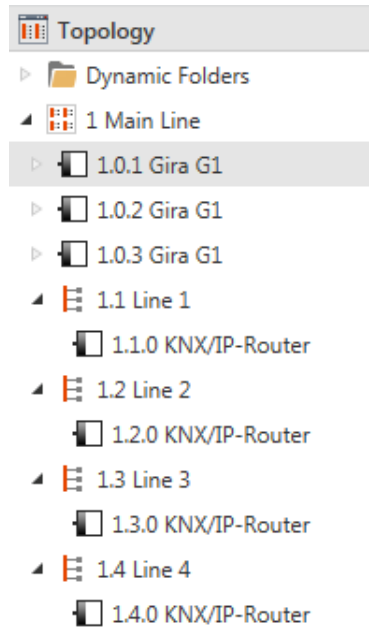

ETS5:

**Figure 2**

ETS screenshot:
Gira G1 in main line
Left: Gira ETS4
Right: Gira ETS5

2.4.2
Gira G1 in area line

The following topology illustrates how the Gira G1 is operated in the area line. In this case the KNX IP router is used as an area coupler and the area/line coupler is used as a line coupler.

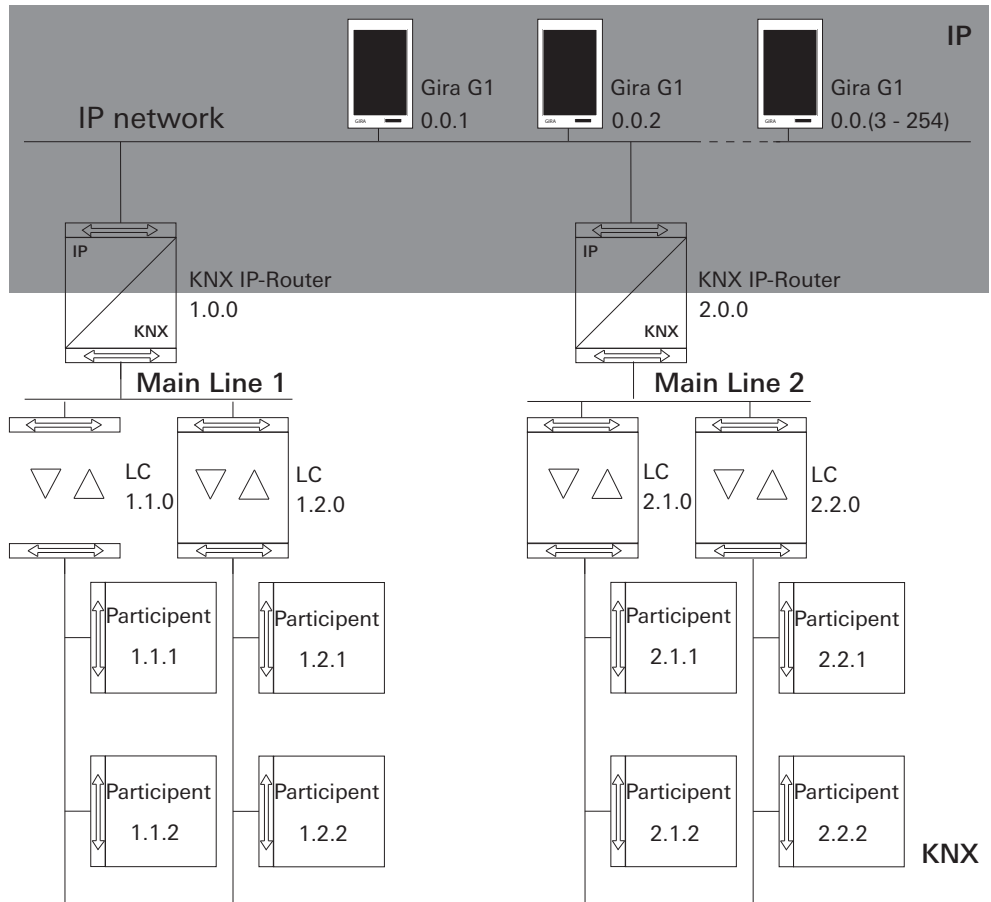
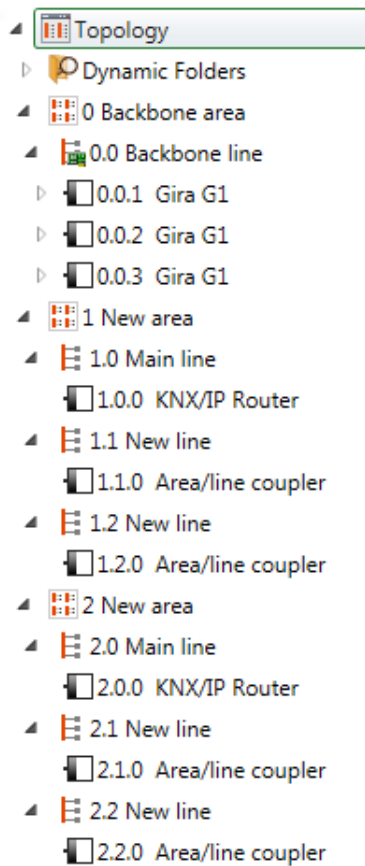

Figure 3
Topology example:
Gira G1 in
area line

When installing the Gira G1 in the area line, the configuration in ETS4 or ETS5 would be as follows:

ETS4:



ETS5:

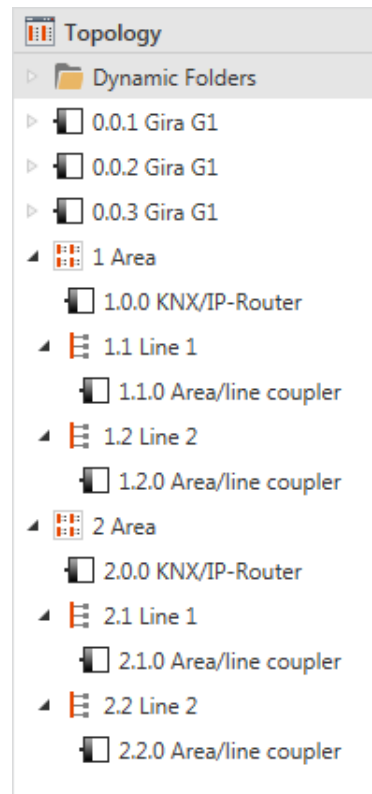

Figure 4
ETS screenshot:
Gira G1 in
area line
Left: Gira ETS4
Right: Gira ETS5

2.5
WLAN topology

The Multicast telegrams used by the KNX system may be lost in WLAN operation. To avoid problems during configuration in WLAN operation, please use one of the two options given below to connect the commissioning PC with the KNX system:

- Tunneling connection via the Gira KNX IP router (Article no. 2167 00, from firmware version 3.0) [see 2.5.1].
- Connection with the line/the area "beneath" a Gira KNX IP router (Article no. 2167 00, from firmware version 3.0) via a KNX USB interface [see 2.5.2].

For both connection types, activate the "Reliable communication" function both on the KNX IP router and on the Gira G1.

Reliable communication

2.5.1
Connecting the commissioning PC via KNX IP router (recommended)

When you establish a tunneling connection (KNXnet/IP), the KNX telegrams from the Gira KNX IP router (Article no. 2167 00, from firmware version 3.0) are also reliably transmitted in the WLAN. Activate the "Reliable communication" function both on the KNX IP router and on the Gira G1.

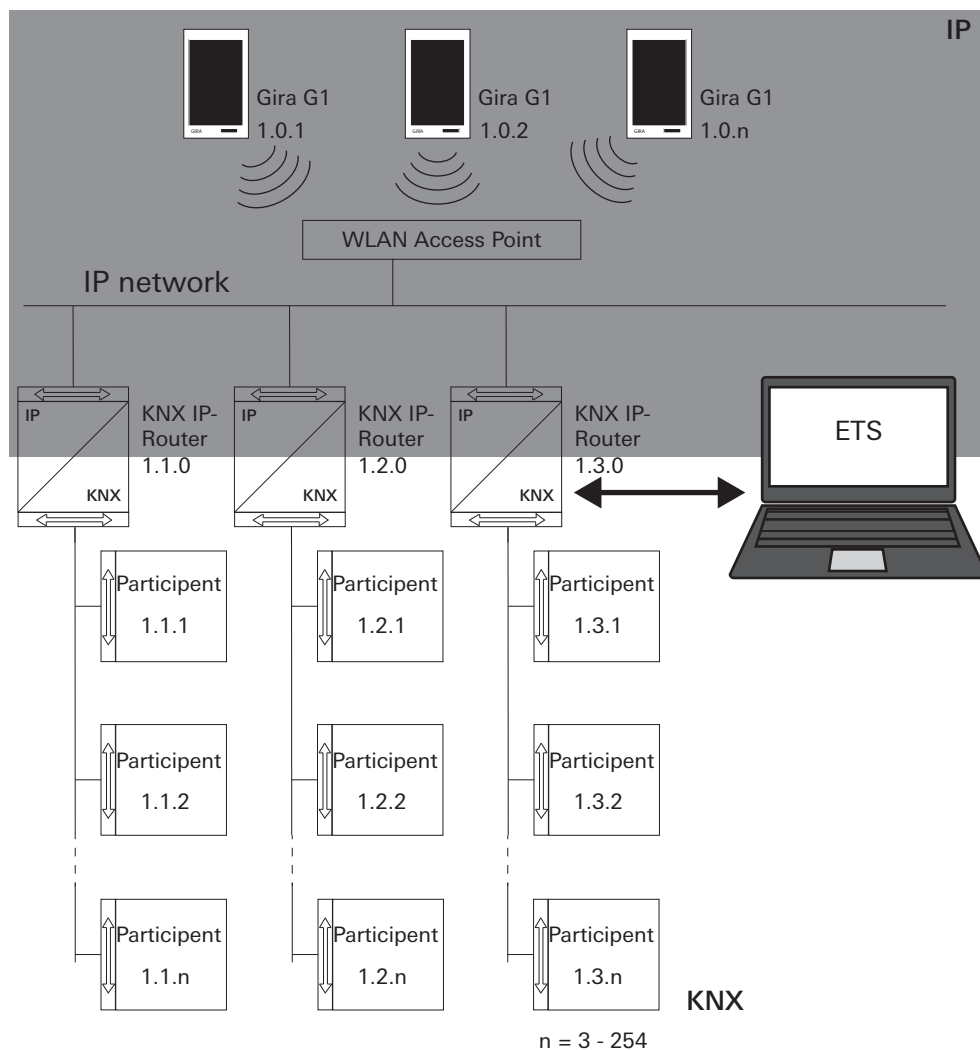

Figure 5
Commissioning via
KNX IP router

2.5.2

Connecting the commissioning PC via KNX USB interface

You can also commission the Gira G1 (WLAN) via a KNX USB interface. All telegrams are reliably transmitted if the "Reliable communication" function is activated on the Gira KNX IP router (Article no. 2167 00, from firmware version 3.0) and on the Gira G1.

Note

Note that the KNX USB interface used must support KNX long frames.

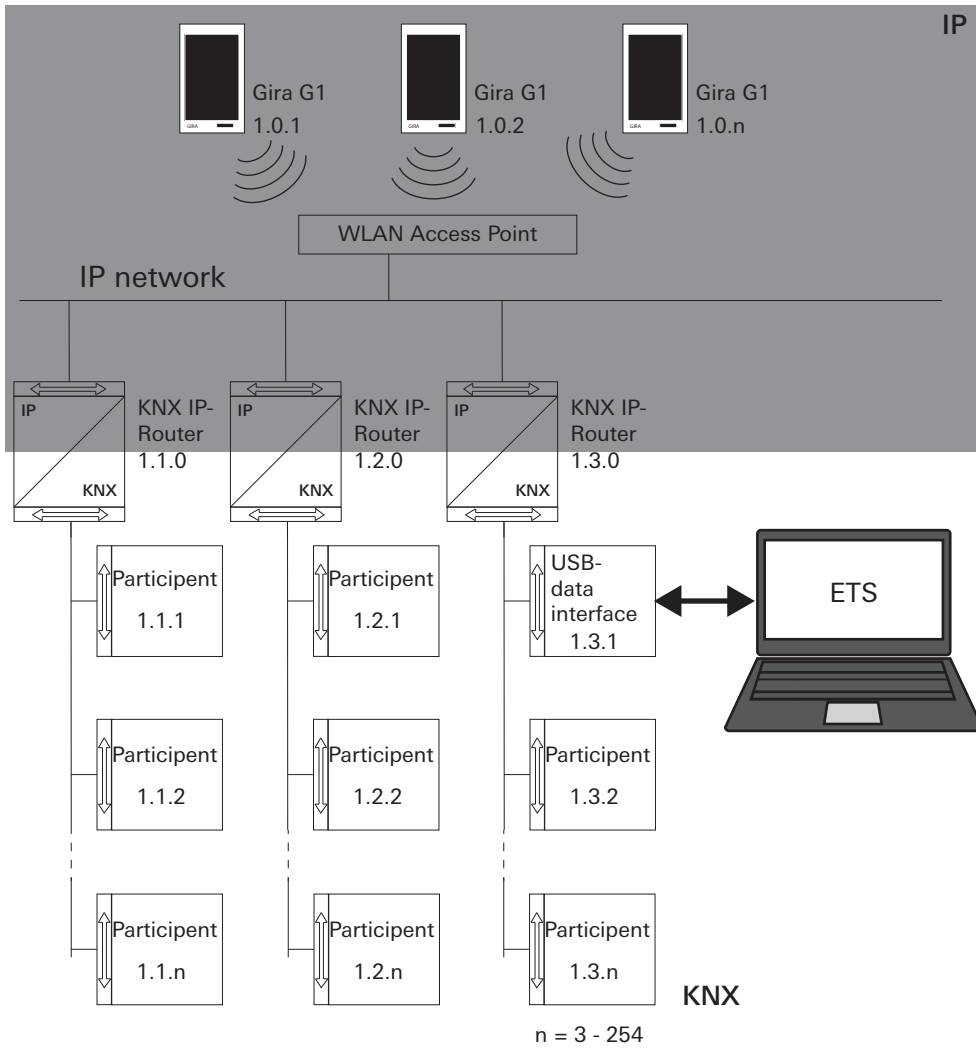

Figure 6
Commissioning via
KNX USB interface

Gira G1 (KNX) settings

Basic settings of the Gira G1 can be made in the [Settings] view.

- 1 Open the [Settings] view by tapping the gear symbol in the navigation bar.
- ✓ This takes you to the [Settings] view with the following subcategories:
- System menu
 - Door communication
 - Weather station
 - Information

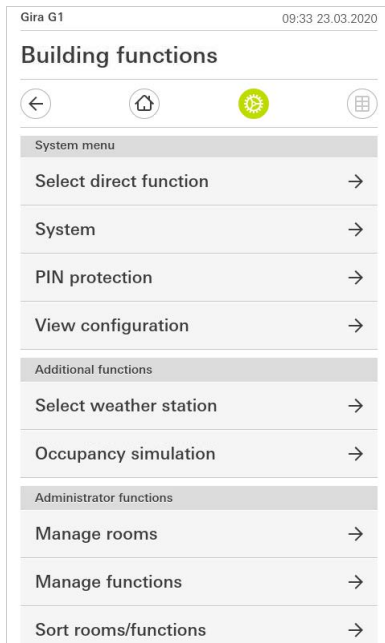

Figure 7
View
[Settings]

Note Number of menu entries

The number of menu entries in the [Settings] view depends on the applications you want to run on the Gira G1.

The following examples always show the complete version. If, for example, you do not want to operate a Gira door communication system, the respective configuration options are not displayed.

3.1

System menu

The following functions are available in the system menu:

- Select direct function [see 3.1.1]
- System [see 3.1.2]
- PIN protection [see 3.1.3]
- View configuration [see 3.1.4]

3.1.1

Select direct function

The direct function is a function that can be operated from any view by placing the palm of the hand on the screen. The "Switching (button function)" and "Scene auxiliary unit" functions can be configured as the direct function. For this it is recommendable to choose one of the room's main functions, e.g switching the ceiling light.

- 1 Tap the [Select direct function] button in the system menu.
- ✓ The [Select direct function] page opens.

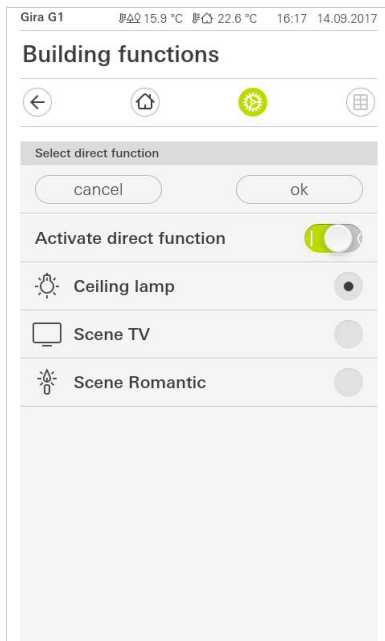

Figure 8
Select direct function

- 2 Activate the [Activate direct function] switch.
- ✓ A selection field appears behind the listed functions. The activated function is indicated by a dot in the selection field.
- 3 Activate the selection field behind the function that you have chosen as the direct function.
- 4 Tap the [OK] button.
- ✓ The data is saved. The system menu opens.

3.1.2 System

- 1 Tap the [System] button in the system menu.
- ✓ The [System] page opens.

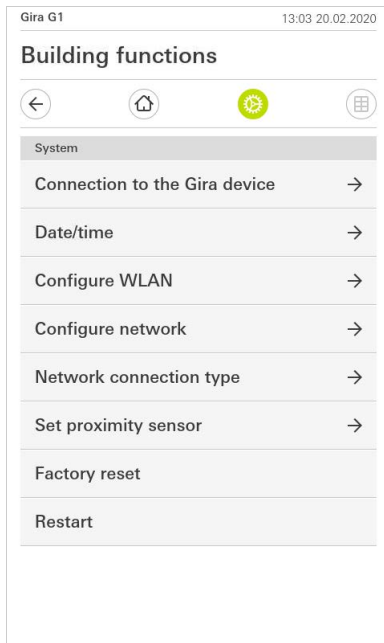

Figure 9
System settings

- ✓ The following menu items are available:
- Date/time [see 3.1.2.1]
 - Configure WLAN [see 3.1.2.2]
 - Configure network [see 3.1.2.3]
 - Network connection type [see 3.1.2.4]
 - Set proximity sensor [see 3.1.2.5]
 - Reliable KNX communication [see 3.1.2.6]
 - Start KNX programming mode
The KNX programming mode can be started or ended using the sliding switch.
The programming LED lights up when the programming mode is active.
 - Factory reset
 - Restart

3.1.2.1

Date/time

Here you can set the time and date format in the status bar.

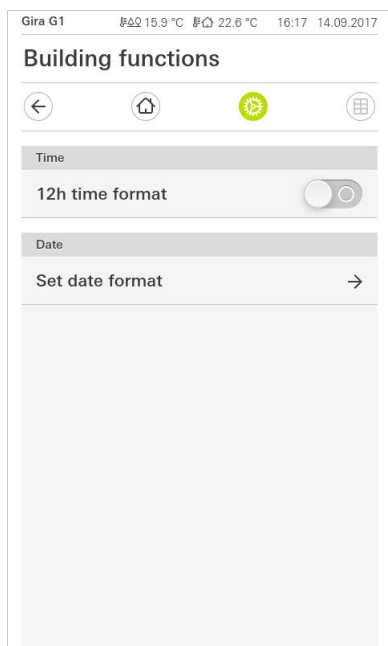

Figure 10
Time/date

- 1 Time: Select 12-hour or 24-hour format.
 - 2 Date: Set the desired date format and accept by tapping [OK].
- ✓ The selected formats are directly displayed in the status bar.

3.1.2.2 Configure WLAN

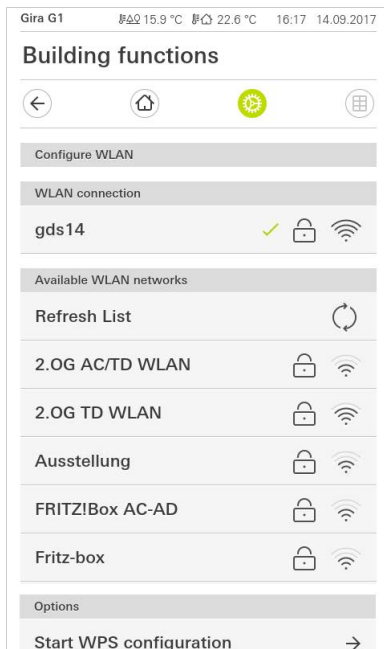

Figure 11
Configure WLAN

The WLAN connection is displayed here if the Gira G1 is already connected to a WLAN network.

WLAN connection

All WLAN networks in the vicinity of the Gira G1 are displayed under "Available WLAN networks". If you wish to connect the Gira G1 to one of the listed WLAN networks, proceed as follows:

Available WLAN networks

- 1 Tap the WLAN network with which you wish to connect the Gira G1.
 - 2 Enter the password for the WLAN network and confirm with [OK].
- ✓ The Gira G1 connects to the WLAN network.

WPS (Wi-Fi Protected Setup) is a function that enables you to set up WLAN connections at the push of a button without entering a password.

Options -
Start WPS configuration

Note **Router without WPS**

If your router does not support WPS (Wi-Fi Protected Setup), you can only set up your wireless network manually.

Connect the Gira G1 to the WLAN as follows via the WPS function:

- 1 On the Gira G1, tap [Start WPS configuration].
- ✓ This displays a view of all WLAN networks that support WPS.
- 2 Select the WLAN network to which you want to connect the Gira G1 and confirm by tapping [OK].
- 3 Activate the WPS function on your WLAN router within the next 2 minutes.
- ✓ The connection to the WLAN network is established automatically.

3.1.2.3

Configure network

Important
Failure of Gira G1

The network connection can fail when settings are changed on the [Configure network] page. This can lead to functional disturbances of the Gira G1. Only an electrician with network expertise is allowed to configure the network.

When configuring the network access of the Gira G1, you can choose between automatic (DHCP) and manual configuration of the network. DHCP is selected in the factory settings of the Gira G1. In this case, the network parameters are automatically specified by the router.

DHCP

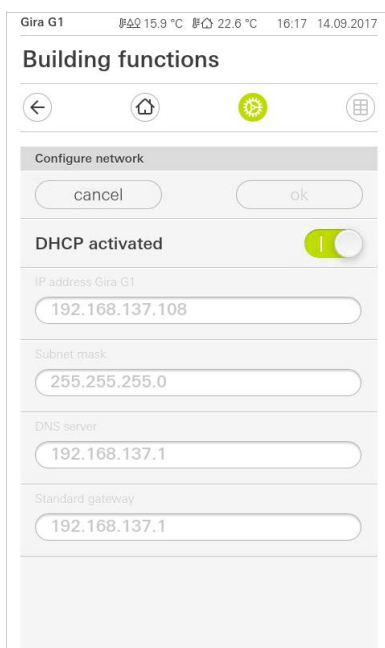

Figure 12
Configure network

To configure the network manually, proceed as follows:

- 1 Deactivate DHCP by moving the "DHCP activated" slider switch to Off.
- ✓ You can now edit the input fields for the network settings.
- 2 Enter the corresponding data for the network access.
- 3 Confirm your entries with [OK].
- ✓ The data is saved. The system menu opens.

Important:
Static IP via ETS

If you specify a static IP address via ETS, you need to manually enter the DNS server on the Gira G1. It is not possible to enter the DNS server via ETS.

3.1.2.4

Network connection type

Specify here if you want to connect the Gira G1 to the network via LAN or WLAN.

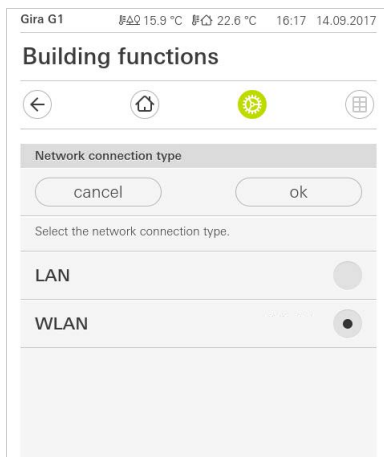

Figure 13
Network
connection type

- 1 Select the desired connection type (LAN or WLAN) and confirm with [OK].
- ✓ The Gira G1 restarts and the network connection type is set.

3.1.2.5

Set proximity sensor

Here you can set the distance at which the Gira G1 is activated from sleep mode when a hand approaches.

- 1 Tap the [Set proximity sensor] button.
- ✓ The [Set proximity sensor] page opens.

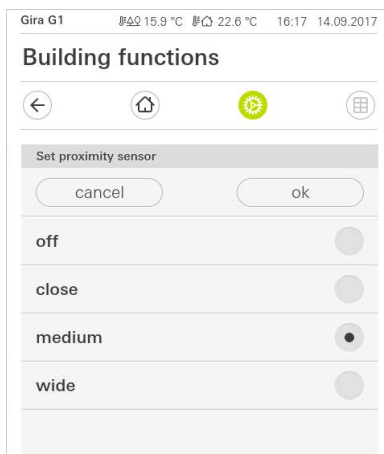

Figure 14
Set proximity sensor

- 2 Choose between the settings of the proximity sensor:
 - off (the proximity sensor is deactivated, i.e., the interface must be tapped to switch on the Gira G1),
 - close (the sensor reacts at a short distance),
 - medium (the sensor reacts at a medium distance),
 - wide (the sensor reacts at a long distance).
 - 3 Tap the [OK] button.
- ✓ The proximity sensor has been set. The system menu opens.

3.1.2.6

Reliable KNX communication

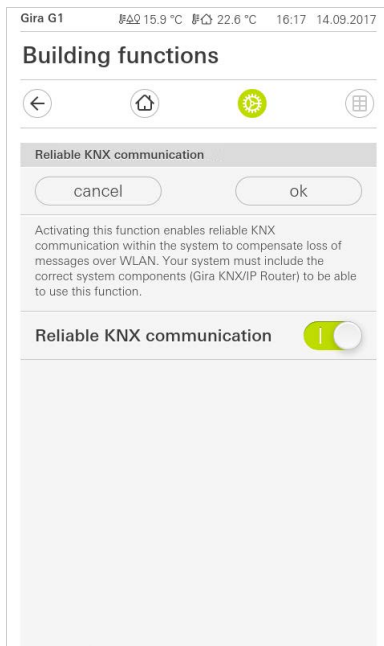

Figure 15
Reliable KNX commu-
nication

The "Reliable KNX communication" function can be activated here. "Reliable KNX communication" is an extension of the KNXnet/IP protocol that serves to minimise data loss in communication via potentially unreliable connections (e.g. WLAN).

Please activate this function if the Gira G1 is connected to the network via WLAN.

To use the "Reliable KNX communication" function, suitable peripheral components with activated reliable KNX communication (e.g. the Gira KNX/IP router 2167 00 from firmware version 3.0) must be used in the system.

3.1.2.7

Calibrate sensor

If you are using the plug-in temperature sensor module for determining the actual temperature, you need to calibrate the temperature value of the sensor during commissioning.

The "Calibrate sensor" menu item is displayed on the Gira G1 only if the "Sensor selection" parameter is set to the value "Internal sensor only" or "Internal sensor + received temperature value" in the ETS under "Room temperature measurement" -> "General".

Before calibrating the internal sensor, measure the room temperature at an appropriate point with an accurate thermometer and note down the value. You then enter the measured value in the sensor calibration menu:

- 1 Tap the [Calibrate sensor] button.
- ✓ The [Calibrate sensor] page opens.

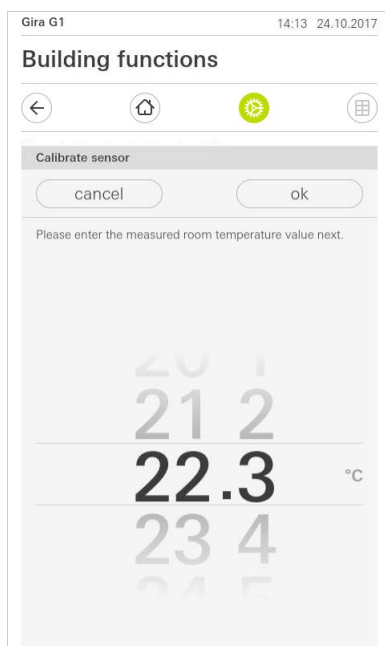

Figure 16
Calibrate sensor

- 2 Enter the measured temperature.
 - 3 Tap the [OK] button.
- ✓ The Gira G1 then progressively adjusts the measured value.
This process may take up to 20 minutes. No specific message is displayed when the calibration is complete. Please do not carry out any further calibrations during the 20-minute waiting time as this can cause problems.

**Note**

If the option "Reset all user data during an ETS programming procedure?" option was activated in the ETS, the temperature calibrated here is reset during an ETS programming procedure.



Note

After the Gira G1 is restarted, it may take up to 30 minutes before it displays a correct temperature reading.

3.1.3

PIN protection

You can add PIN protection for the settings in the system menu. This protects the Gira G1 against unwanted changes. To activate PIN protection, proceed as follows:

- 1 Tap the [PIN protection] button.
- ✓ The [PIN protection] page opens.

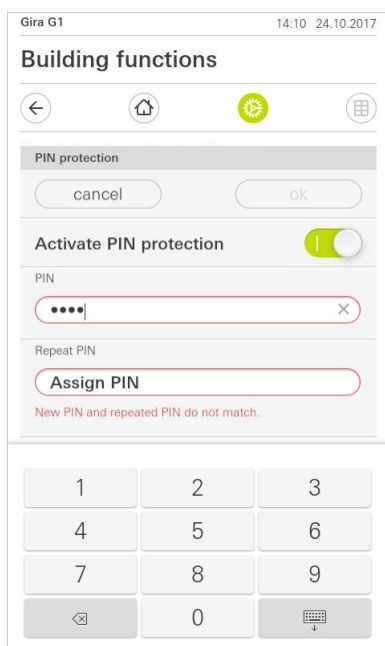

Figure 17
PIN protection

- 2 Slide the "Activate PIN protection" switch to the right.
 - 3 Enter a PIN in the upper box and repeat it in the second box.
 - 4 Confirm the entry with [OK].
- ✓ The system menu of the Gira G1 can now only be opened after the PIN is entered.

3.1.4

View configuration

In the view configuration, you define the functions displayed and the order of the functions for the action area.

- 1 Tap the [View configuration] button.
- ✓ The [View configuration] page opens.

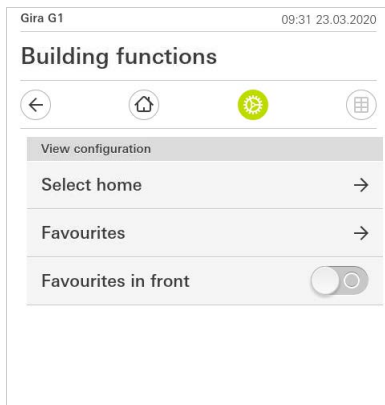

Figure 18
View configuration

- ✓ The following menu items are available:
 - Select Home [see 3.1.4.1]
 - Favourites with sub-items
 - Define favourites [see 3.1.4.2]
 - Sort functions [see 3.1.4.3]
 - Restore defaults [see 3.1.4.4]
 - Favourites in front [see 3.1.4.5]

3.1.4.1

Select Home

Here you can define whether the Home view is displayed in tile or detail view when the Home button is tapped.

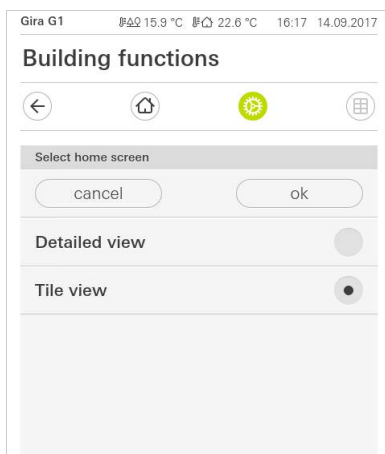

Figure 19
Select Home

- 1 Select the desired view for the Home view.
- 2 Tap the [OK] button.

3.1.4.2

Define favourites

You can select the functions to be displayed directly in the action area here.

- 1 Open the [View configuration] page.
- 2 Tap the [Favourites] button, then tap [Define favourites].
- ✓ The [Define favourites] page opens and displays all the existing function folders.

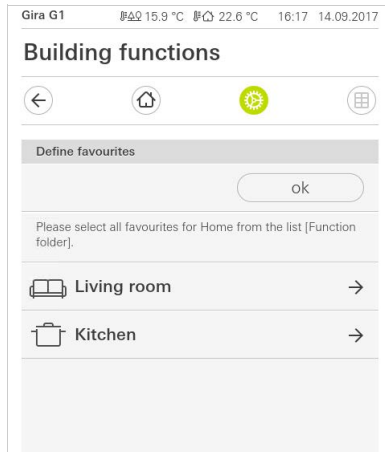

Figure 20
Define favourites

- 3 Switch to the function folder containing the function you want to display as a favourite.
- ✓ The [Define favourites, function folder] page opens.

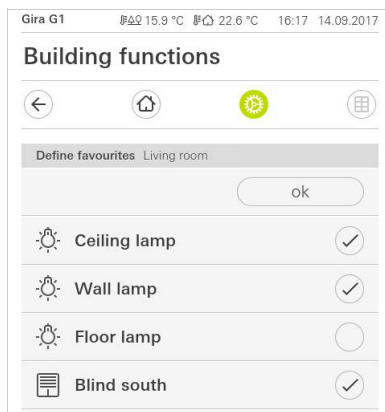

Figure 21
Select functions

- 4 Activate the functions that you wish to import as favourites.
- 5 Tap [OK].
- ✓ The [Define favourites] page opens with the list of function folders.
- 6 Define additional favourites in the same way.
- 7 When you are finished, tap [OK].
- ✓ The [View configuration] page opens.
- 8 Close and save your settings:
Tap [OK].
- ✓ A message informs you that changes have been made.
- 9 Confirm this by tapping [OK].
- ✓ The Gira G1 restarts. The defined favourites then appear in the action area.

3.1.4.3

Sort functions

Here you can determine the order in which the functions and applications are displayed in the Home area of the Gira G1.

- 1 Open the [View configuration] page.
- 2 Tap the [Favourites] button, then tap [Sort functions].
- ✓ The [Sort functions] page opens and displays all the elements available on the Gira G1.

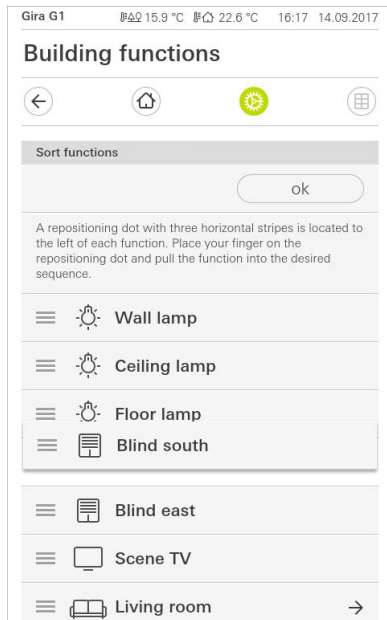

Figure 22
Sort functions

- 3 Place your finger on the shifting point of the desired entry and move the functions into the order you want.
- 4 Use the same method to move other entries.
- 5 When you are finished, tap [OK].
- ✓ The [Favourites] page opens.
- 6 Close and save your settings:
Tap [OK].
- ✓ A message informs you that changes have been made.
- 7 Confirm this by tapping [OK].
- ✓ The Gira G1 restarts. The favourites then appear in the action area in the order defined by you.

3.1.4.4

Restore defaults

Here you can restore the action area view to the original state set during ETS configuration.

- 1 Open the [View configuration] page.
- 2 Tap the [Favourites] button, then tap [Restore defaults].
- ✓ A message appears asking whether you want to reset all settings to the original state at commissioning.
Confirm this by tapping [OK].
- ✓ The Gira G1 restarts. The favourites appear in the action area in their original state at commissioning.

3.1.4.5

Favourites in front

This is where you can determine whether your favourites should be displayed on the home view.

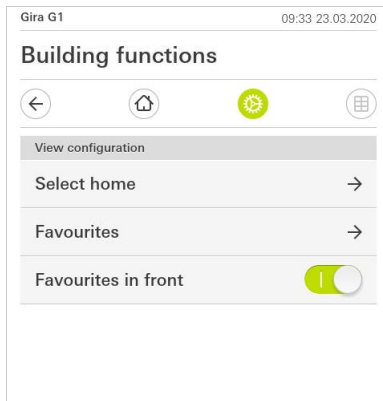

Figure 23
Favourites in front

- 1 Slide the slider switch to the right if the favourites functions should be displayed in front of other tiles, such as "Building", "Door communication" and "Weather forecast".

✓ Your favourites will be displayed first in the home view.

3.2

Information

The following functions are available in the Information area:

- License agreement
This is where the license agreements for the Gira G1 are displayed.
- Gira app version ... [see 3.2.1]

3.2.1

Gira app version

This area provides you with information on the installed and potentially available versions of the Gira Smart Home app:

- Installed version
Here you will see the currently installed version of the Gira Smart Home app installed on the Gira G1.
- Available versions
If an update is available for the Gira Smart Home app, it will be displayed here. To install the app update, simply tap the new version.

4

Operating the Gira G1 (KNX)



Note

The appearance and behaviour of the KNX functions can vary depending on the ETS parameterisation. Colours, symbols and labels can be parameterised individually for each function in the ETS.

A tiled or detailed view is available for each KNX function. You can change to the detailed view of the function by tapping the tile.

4.1

Structure of the user interface

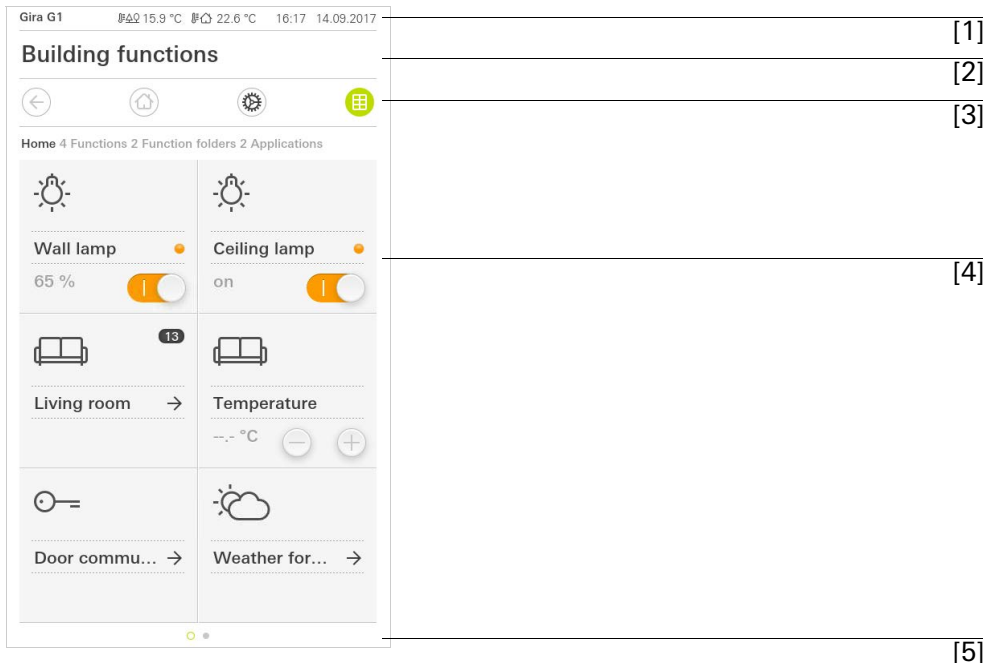

Figure 24
User interface

The user interface of the Gira G1 is divided into 5 areas:

- [1] Status bar [see 4.2]
- [2] Information bar (displays which application is open)
- [3] Navigation bar [see 4.3]
- [4] Action area [see 4.4]
- [5] Orientation guide

At the lower edge of the screen you will see a circle for every available function or page. The circle marked shows the current position. By swiping horizontally, you can change the function or page. This also causes the marked circle to shift.

4.2

Status bar



Figure 25
Gira G1 status bar

The symbols in the status bar have the following meanings:

- [1] The status display (Gira G1 / DCS) shows which system is configured:
"Gira G1" if a KNX system is configured,
"DCS" if the Gira G1 is run exclusively in the Gira door communication system.
- [2] Display of the outdoor temperature in degrees Celsius (°C). The outdoor temperature values are obtained from the KNX system or from a KNX weather station.
- [3] Display of the room temperature in degrees Celsius (°C). The values for the room temperature are obtained either from the KNX system, e.g. from a KNX pushbutton sensor, or from the optionally available temperature sensor module.
- [4] "Automatic door opener" is displayed when automatic door opening has been activated.*
- [5] "Forwarding" is displayed if door call forwarding is activated on a mobile phone.*
- [6] The warning symbol in the status bar shows that the Gira G1 is no longer functioning.
If you tap the warning symbol, the relevant error message is displayed.
- [7] Time and date display.

*only displayed when using the Gira door communication system.

4.3

Navigation bar



Figure 26
Gira G1
navigation bar

The buttons in the navigation bar have the following functions:

- [1] [Back] opens the previously opened page.
- [2] [Home] opens the home page of the action area.
- [3] [System] opens the [Settings] view.
- [4] [Change view] switches between tile and detail view.

4.4

Action area

The action area is the central working area through which you can operate and adjust the settings of the Gira G1. Here you can operate all of the applications, e.g. the weather forecast, the Gira door communication system, the function folders and the KNX functions.

The action area has two view options:

- Tile view
 - Detail view
-

4.5

Direct function

The "Palm operation" gesture activates the direct function. By placing the palm of your hand on the display, you can directly access a predefined main function. In this way, the Gira G1 becomes a simple switch with which the ceiling lamp can be switched on and off, for example. The main function is superimposed over the screen that is currently active and automatically disappears again after a certain period of time.

"Palm operation"

The function that is to be triggered using the direct function can be defined in the system menu [see 3.1.1].

4.6

Tile view

Tile view is one of the two view options of the action area, along with detail view. All the building functions can be displayed here as tiles. In addition, individual functions can be bundled in a function folder, e.g. for all functions in one room.

You can display up to six small tiles in the tile view.

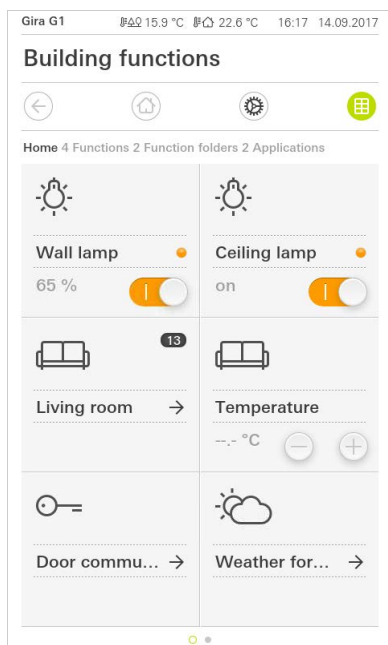

Figure 27
Example
Tile view

Central functions such as switching on and off, setting the temperature, or dimming in fixed steps can be operated directly within this view. To do this, tap Plus/Minus or the arrow buttons to dim the light, adjust the temperature or move blinds/shutters.

Operation in tile view

When you tap a tile, the detail view of the function opens. There (depending on the configuration) you can carry out additional operations in the function.

4.7
Detail view

Detail view is one of the two view options of the action area, along with tile view. Detail view is opened by tapping on a tile in tile view. All operating elements of the relevant function are then available on the entire display. Operation for most functions is by tapping, with some functions, such as the blind control, distinguishing between a short and long press of the button. You can switch from one function to the next with a horizontal swiping movement of the finger.

Horizontal swiping

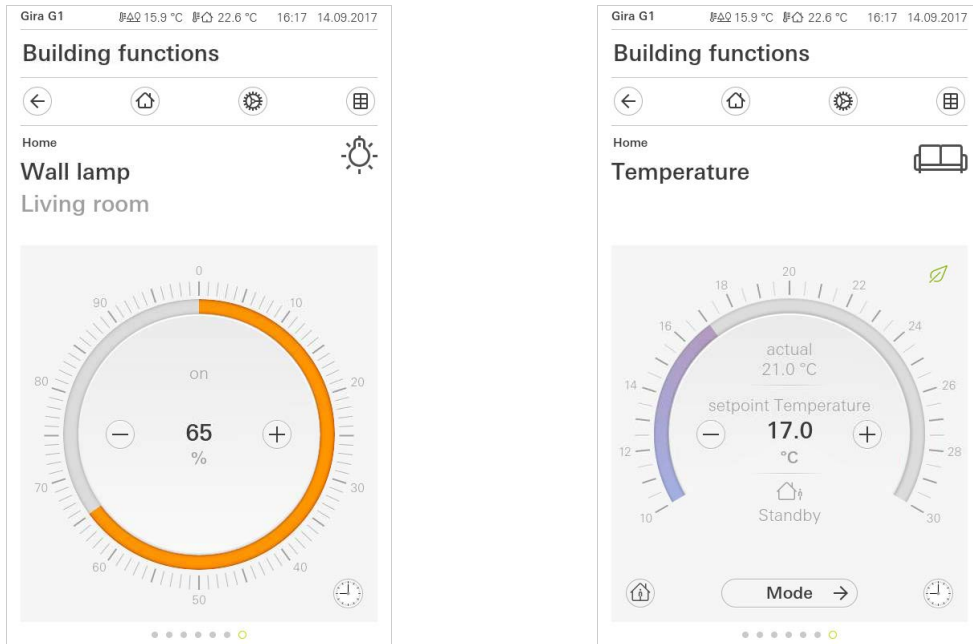

Figure 28
Example
Detail view

The adjustable scale can be used in the [Dimmer] and [Heating] functions. In order to adjust e.g. the brightness or setpoint temperature, tap directly on the desired value in the scale or move the adjustable scale to the desired position.

Adjustable scale

Note
Hold finger on start position

Before moving the finger, briefly rest it (approx. 1 s) on the start position of the scale to allow the Gira G1 to carry out the position correction.

Blinds or shutters can be controlled using the slide control in the detail view. To move blinds or shutters up or down or adjust the slats, slide the controller to the desired position.

Blind/shutters
Operation using slide control

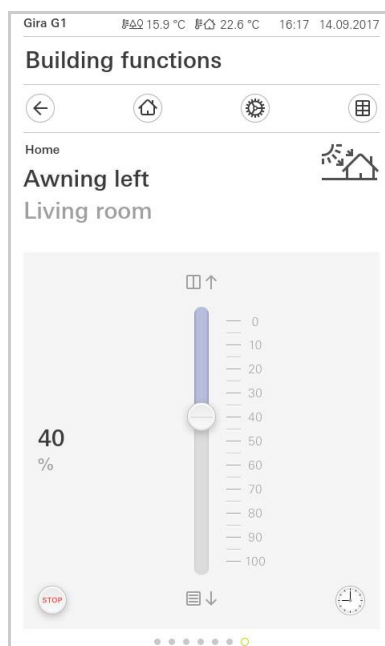
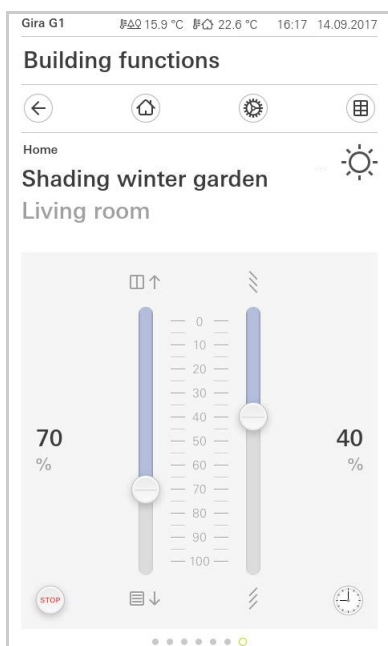

Figure 29
Detail view
Operation using
slide control

When you tap the [STOP] button, you can directly stop active movement of the hanging or a slat adjustment. The hanging then stops immediately at its current position.

Stop button

4.8

Scene auxiliary unit

A scene is a grouping of actions which are always carried out together. This means, for example, that specific preferences are stored for any situation in a room, and these presets can be called up at the push of a button. This allows you to create the "TV" scene, for example, and to activate it with a function of the Gira G1. If this scene is activated, the blinds move to a certain position, the lighting is dimmed to a defined value, the screen is lowered and the projector switched on.

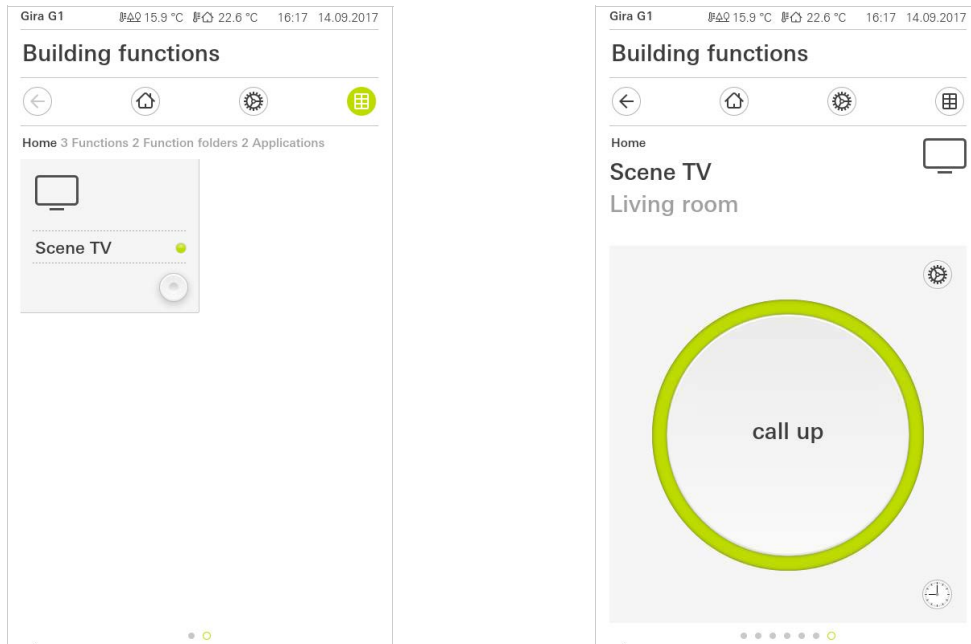

Figure 30
Scene auxiliary unit
Left: Tile view
Right: Detail view

In detail view, a save telegram for the scene can be triggered to save new values for the functions of the scene.

Save scene

Note Assigning functions of a scene in ETS

Functions (e.g. lights, blinds or shutters) must have been assigned during configuration of a scene.

By saving a scene, previously saved values of a scene are overwritten.

If you want to save new values for the functions present in a scene:

- 1 Tap the [Settings] button in the detail view of the scene.
- ✓ The [Set scene] page opens.
- 2 Set all the devices assigned to this scene as desired (e.g. brightness value, blind position). When the scene is activated, these devices will be operated with those values.
- 3 Tap the [Save scene] button.
- ✓ A note appears.
- 4 Tap the [OK] button.
- ✓ The [Set scene] page opens. The scene has been saved.

4.9

Room temperature presence button and mode

The presence button can be used to activate the comfort temperature from night mode or frost/heat protection. This function can be used to raise the room temperature to the comfort temperature for a period of time if the room is used during night time hours as an exception (e.g. for a party).

If the presence button is pressed in standby mode, the comfort mode is switched on indefinitely.

You can use the [Mode] button to switch between various operating modes ("Comfort", "Night", etc.) to which different setpoint temperatures are assigned.

- To switch operating mode, tap [Mode].
- ✓ The operating mode page opens.

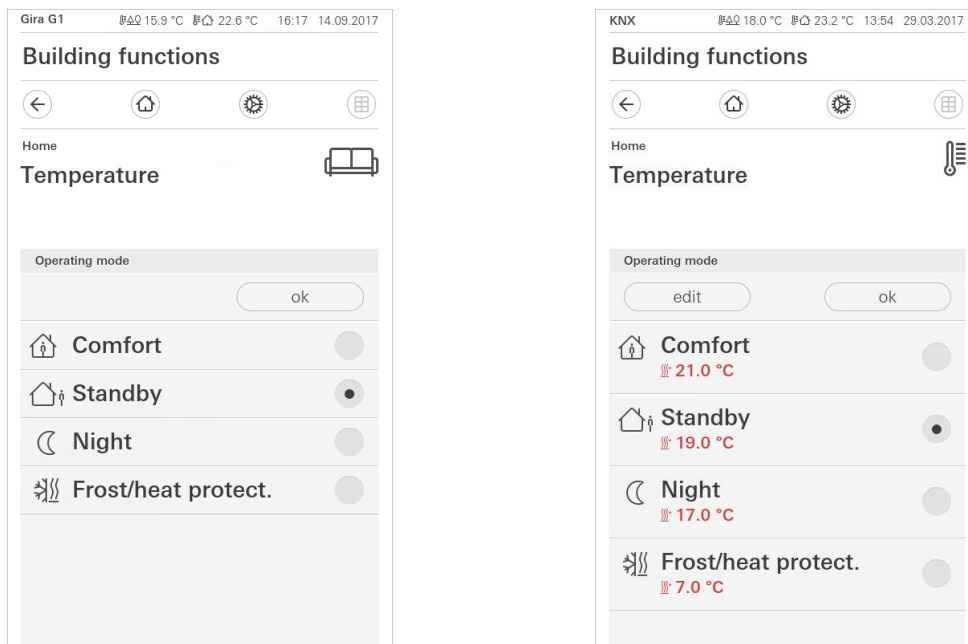

Presence button
(comfort extension)

Changing the mode

Figure 31
Switching operating mode
Left: Room temperature controller auxiliary unit
Right: Room temperature controller

- Select the desired mode and confirm with [OK].
- ✓ The detail view of the room temperature controller is displayed. The desired mode has been set.

The various modes have the following meanings:

- Comfort
Comfort mode is activated if people are in a room and the room temperature is to be set to a comfortable value.
- Standby
Activate standby if a room is not used during the day. This adjusts the room temperature to a standby value, enabling heating or cooling energy to be saved.

- **Night**
Activate night mode during night hours or during a long absence. This adjusts the room temperature to cooler temperatures in heating systems (e.g. in bedrooms). In this case, cooling systems can be set to higher temperature values when air conditioning is not necessary (e.g. in offices).
- **Frost/heat protection**
Frost protection is required when, for example, the room temperature is not to fall below critical values when a window is open. Heat protection may be necessary when the temperature becomes too high due to external influences. In these cases, freezing or overheating of the room can be prevented by specifying an individual temperature setpoint by activation of the frost/heat protection, depending on the "Heating" or "Cooling" operating mode.

When the Gira G1 is used as a room temperature controller, the setpoint temperatures of the "Comfort", "Standby" and "Night" operating modes can be changed in the [Operating mode] view.

Changing the setpoint temperatures of the operating modes

- 1 Tap the [Mode] button to change the setpoint temperature of an operating mode.
- ✓ The [Operating mode] page opens.
- 2 Tap the [Edit] button.
- 3 Tap the operating mode for which you want to change the setpoint temperature.
- 4 Set the desired setpoint temperature.
- 5 Tap [OK]
- 6 Repeat the procedure if you want to change the temperature of an additional operating mode.
- 7 Tap [OK] once you have concluded all changes.
- ✓ The changed setpoint temperatures have been saved and can be used.
Please note: These changes can only be reset to the default values via ETS if the option "Overwrite user data during an ETS programming operation?" has been activated in the parameters.

4.10 Timer

The timer is easy to operate and can be used to control many functions. It allows certain functions to be triggered at a specified time every day or only on certain days. For example, the blinds are automatically raised every morning and lowered again in the evening, or the heating automatically switches to night mode.

A timer can be set up in the following functions:

- Switching with 10 switching times
- Dimming with 10 switching times
- Blind/shutter functions with 10 switching times
- Value transmitter with 10 switching times
- Scene auxiliary unit with 10 switching times
- Temperature controller functions with 28 switching times

4.10.1

Creating a switching time

- 1 Tap the [Timer] button in the detail view of the relevant function.
- ✓ The [Timer overview] page opens.

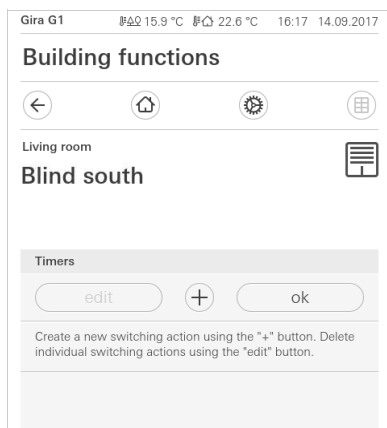

Figure 32
Overview
Timer

- 2 Tap the [+] button.
- ✓ The [Timer] page opens.

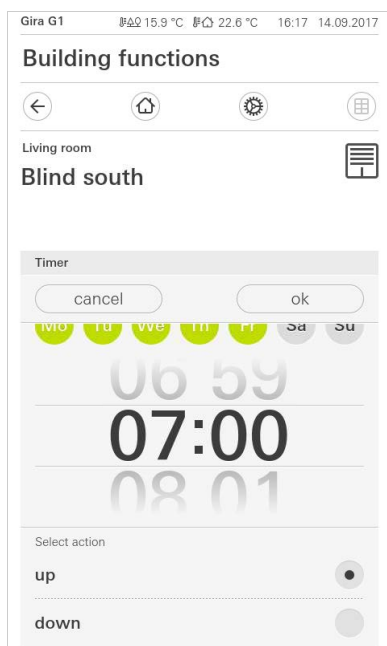

Figure 33
Creating a switching
time

- 3 You can activate or deactivate the days on which the timer is to apply with a finger tap. Days on which the timer is active are marked green.
 - 4 Enter the time at which the action is to be carried out.
 - 5 Under "Select action", choose the function to be set up. The type of value that can be selected here depends on the function to be set up.
 - 6 Tap the [OK] button.
- ✓ The timer is set.

4.10.2

Deleting a switching time

- 1 Open the [Timer overview] page.
- 2 Tap the [Edit] button.
- 3 Mark the switching time to be deleted.
You can also mark and delete several switching times here.
- ✓ A red tick appears in front of the switching time. The red [Delete] button is shown.
- 4 Tap the [Delete] button.
- ✓ The [Timer overview] page opens. The marked switching time is deleted.

4.10.3

Activating and deactivating all switching times for a function

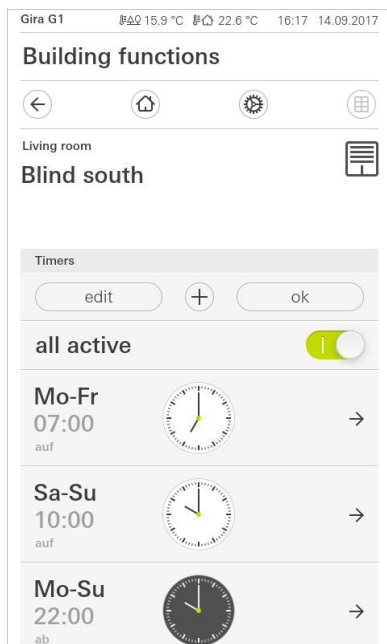

Figure 34
Activating/deactivating all switching times

- 1 Set the switch [Activate all] to [I] to activate or to [O] to deactivate.
- 2 Tap the [OK] button.
- ✓ The function from which you switched to the [Timer overview] page opens.
All switching times for this function are activated or deactivated.

Tip
Temporarily deactivating switching times

If you want to temporarily deactivate individual switching times for a function, you can simply deactivate all days (set to grey).

4.11 Function folder

Functions are stored in function folders.

Individual functions can be bundled in a function folder, e.g. all the light functions, to provide a better overview. Function folders also offer the possibility of mapping a simple building structure, e.g. all functions in a room.

A function folder can contain a maximum of 25 functions.

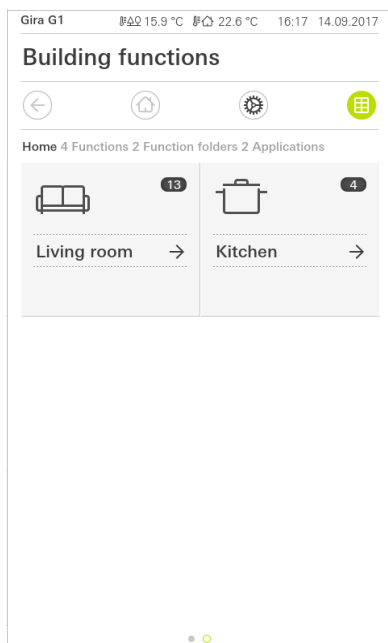

Figure 35
Function folder

Configuring the Gira X1 Client

The following prerequisites must be fulfilled for commissioning to be successful:

- The Gira X1 must be configured to be functional.
- When configuring the Gira X1 in the Gira Project Assistant, a user must be configured for the Gira G1.
- The Gira G1, the Gira X1 and the commissioning PC (with Gira Project Assistant installed) must be located on the same network.

5.1

Initial commissioning

Once you have selected the “Gira X1 and security system” option in the Gira G1’s basic configuration, the initial commissioning configuration starts up, followed by a dialog that allows you to make the connection to the Gira X1.

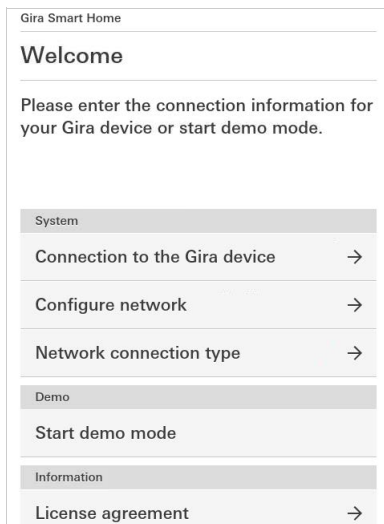

Figure 36
View
[Settings]

- 1 If the Gira G1 is connected to the network via LAN and DHCP, you can proceed directly to step 2.
If the Gira G1 is connected to the network via WLAN and/or without DHCP, you must first connect to the network before you can connect to the Gira X1.
- 2 Enter the connection data (user name and password), which you created earlier for the Gira G1 in the GPA [see 6.1.2.1].
- 3 Enter the access data for the door communication system, if appropriate [see 15.2.1].
- 4 Select the locations for the weather station, as appropriate [see 17.1.1].



Note
Maximum number of functions to be configured

Please note that out of the 250 permitted functions, you may use a maximum of 60 dimming or temperature functions (with adjustable scale).

Gira X1 Client settings

Basic settings of the Gira G1 can be made in the [Settings] view.

- 1 Open the [Settings] view by tapping the gear symbol in the navigation bar.
- ✓ This takes you to the [Settings] view with the following subcategories:
 - System menu [see 6.1]
 - Additional functions [see 6.2]
 - Administrator functions* [see 6.3]
 - Door communication** [see 16]
 - Information [see 6.4]

* Only if the user has administrator rights.

** only if the application was selected during commissioning.

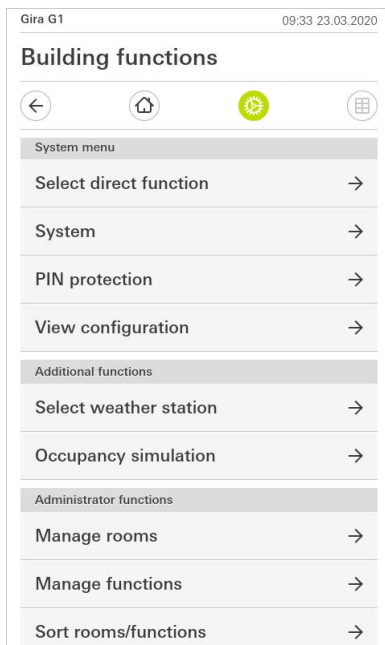

Figure 37
View
[Settings]

Note Number of menu entries

The number of menu entries in the [Settings] view depends on the applications you want to run on the Gira G1.

The following examples always show the complete version. If, for example, you do not want to operate a Gira door communication system, the respective configuration options are not displayed.

6.1

System menu

The following functions are available in the system menu:

- Select direct function [see 6.1.1]
- System [see 6.1.2]
- PIN protection [see 6.1.3]
- View configuration [see 6.1.4]

6.1.1

Select direct function

The direct function is a function that can be operated from any view by placing the palm of the hand on the screen. The "Switching (button function)", "Button (On/Off)", "Button (Press/Release)" and "Scene auxiliary unit" functions can be configured as the direct function.

It is recommended to choose one of the main functions of the room in which the Gira G1 is positioned here, e.g switching the ceiling light.

- 1 Tap the [Select direct function] button in the system menu.
- ✓ The [Select direct function] page opens.

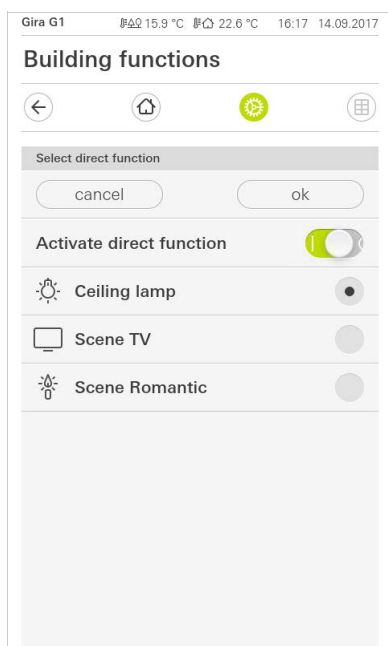

Figure 38
Select direct function

- 2 Activate the [Activate direct function] switch.
- ✓ A selection field appears behind the listed functions. The activated function is indicated by a dot in the selection field.
- 3 Activate the selection field behind the function that you have chosen as the direct function.
- 4 Tap the [OK] button.
- ✓ The data is saved. The system menu opens.

6.1.2 System

- 1 Tap the [System] button in the system menu.
✓ The [System] page opens.

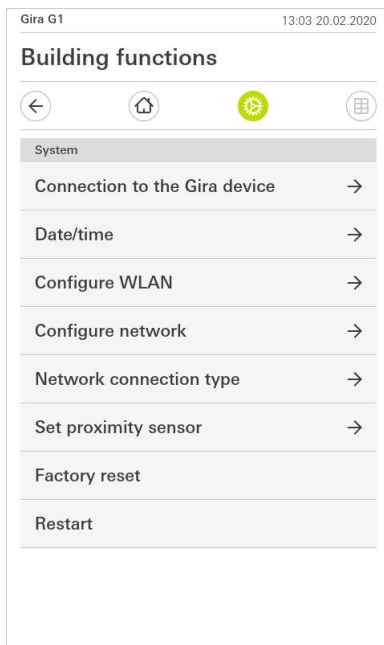
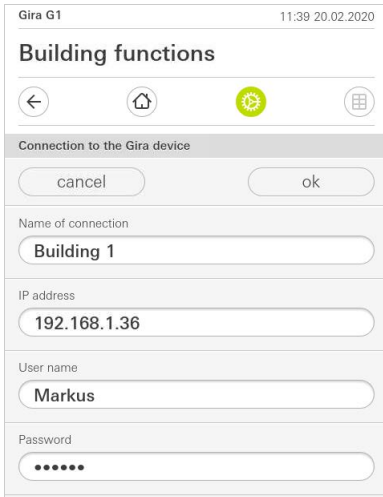

Figure 39
System settings

- 2 The following menu items are available:
 - Connection to the Gira device [see 6.1.2.1]
 - Change password [see 6.1.2.2]
 - Date/time [see 6.1.2.3]
 - Configure WLAN [see 6.1.2.4]
(only displayed if "WLAN" was selected as the network connection type)
 - Configure network [see 6.1.2.5]
 - Network connection type [see 6.1.2.6]
 - Set proximity sensor [see 6.1.2.7]
 - Factory reset
 - Restart

6.1.2.1

Connection to the Gira device



The screenshot shows the 'Building functions' screen on a Gira G1 device. The title bar displays 'Gira G1' and the time '11:39 20.02.2020'. Below the title bar, there are navigation icons: a back arrow, a home icon, a gear icon (highlighted in green), and a list icon. The main content area is titled 'Connection to the Gira device' and contains a 'cancel' button and an 'ok' button. Below these buttons are four input fields: 'Name of connection' with the value 'Building 1', 'IP address' with the value '192.168.1.36', 'User name' with the value 'Markus', and 'Password' with six dots representing a masked password.

Figure 40
Connection to Gira X1

To connect the Gira G1 to the Gira X1, proceed as follows:

- 1 Enter the IP address of the Gira X1.
 - 2 Enter the user name and password.
 - 3 Confirm your entries with OK.
- ✓ The data is saved. The connection to Gira X1 is created.

6.1.2.2

Change password

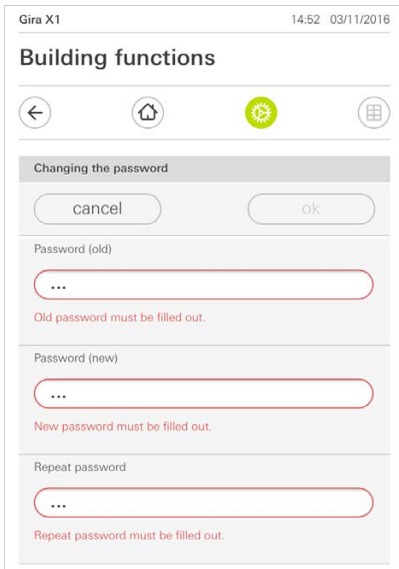

The screenshot shows the 'Building functions' screen on a Gira X1 device. The title bar displays 'Gira X1' and the time '14:52 03/11/2016'. Below the title bar, there are navigation icons: a back arrow, a home icon, a gear icon (highlighted in green), and a list icon. The main content area is titled 'Changing the password' and contains a 'cancel' button and an 'ok' button. Below these buttons are three input fields: 'Password (old)' with three dots and a red error message 'Old password must be filled out.', 'Password (new)' with three dots and a red error message 'New password must be filled out.', and 'Repeat password' with three dots and a red error message 'Repeat password must be filled out.'

Figure 41
Change password

You can change the user password assigned during configuration. Proceed as follows:

- 1 Enter the old password.
 - 2 Enter a new password.
 - 3 Repeat the new password.
 - 4 Confirm your entries with OK.
- ✓ The new password is now saved.

6.1.2.3

Date/time

Here you can set the time and date format in the status bar.

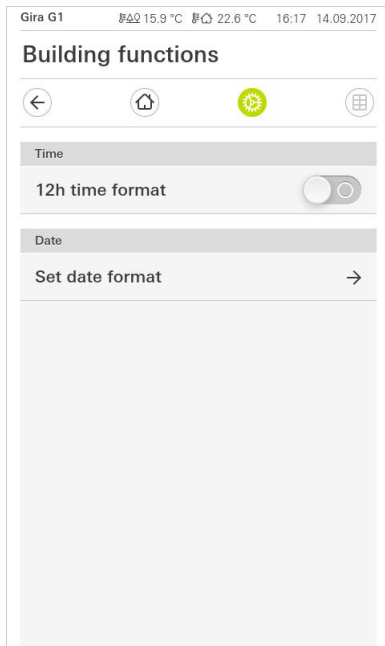

Figure 42
Time/date

- 1 Time: Select 12-hour or 24-hour format.
 - 2 Date: Set the desired date format and accept by tapping [OK].
- ✓ The selected formats are directly displayed in the status bar.

6.1.2.4 Configure WLAN

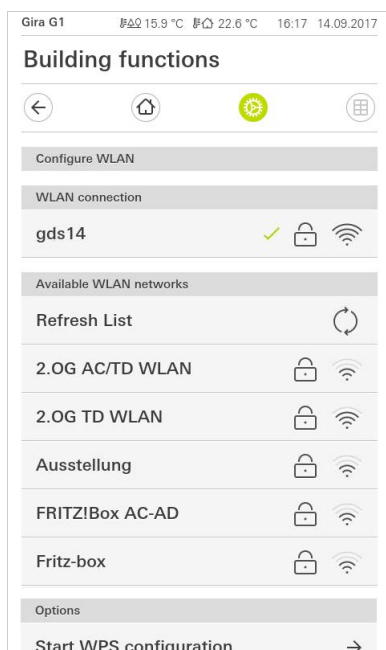

Figure 43
Configure WLAN

The WLAN connection is displayed here if the Gira G1 is already connected to a WLAN network.

WLAN connection

All WLAN networks in the vicinity of the Gira G1 are displayed under "Available WLAN networks". If you wish to connect the Gira G1 to one of the listed WLAN networks, proceed as follows:

Available WLAN networks

- 1 Tap the WLAN network with which you wish to connect the Gira G1.
 - 2 Enter the password for the WLAN network and confirm with [OK].
- ✓ The Gira G1 connects to the WLAN network.

WPS (Wi-Fi Protected Setup) is a function that enables you to set up WLAN connections at the push of a button without entering a password. The router must support WPS to use this function.

Options - Start WPS configuration

Connect the Gira G1 to the WLAN as follows via the WPS function:

- 1 On the Gira G1, tap [Start WPS configuration].
- ✓ This displays a view of all WLAN networks that support WPS.
- 2 Select the WLAN network to which you want to connect the Gira G1 and confirm by tapping [OK].
- 3 Activate the WPS function on your WLAN router within the next 2 minutes.
- ✓ The connection to the WLAN network is established automatically.

6.1.2.5

Configure network

**Warning**
Failure of Gira G1

The network connection can fail when settings are changed on the [Configure network] page. This can lead to functional disturbances of the Gira G1.

Only an electrician with network expertise is allowed to configure the network.

When configuring the network access of the Gira G1, you can choose between automatic (DHCP) and manual configuration of the network. DHCP is selected in the factory settings of the Gira G1. In this case, the network parameters are automatically specified by the router.

DHCP

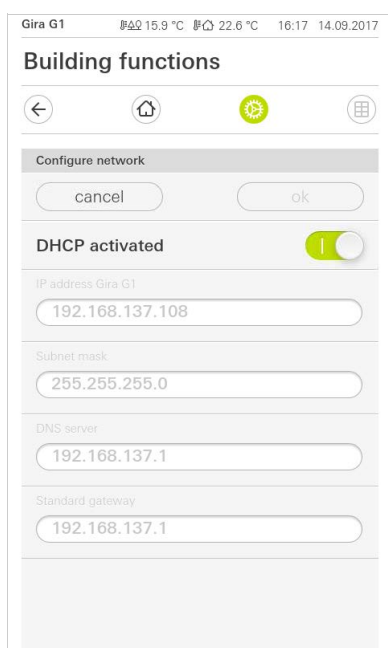

Figure 44
Configure network

To configure the network manually, proceed as follows:

- 1 Deactivate DHCP by moving the "DHCP activated" slider switch to Off.
- ✓ You can now edit the input fields for the network settings.
- 2 Enter the corresponding data for the network access.
- 3 Confirm your entries with [OK].
- ✓ The data is saved. The system menu opens.

6.1.2.6

Network connection type

Specify here if you want to connect the Gira G1 to the network via LAN or WLAN.

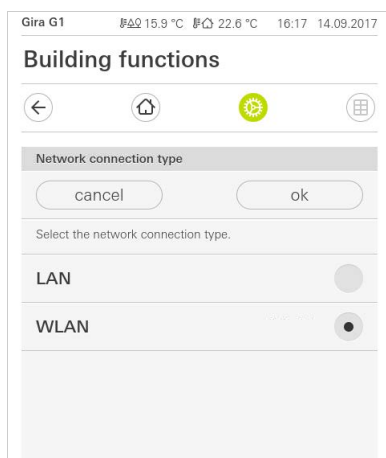

Figure 45
Network
connection type

- 1 Select the desired connection type (LAN or WLAN) and confirm with [OK].
- ✓ The Gira G1 restarts and the network connection type is set.

6.1.2.7

Set proximity sensor

Here you can set the distance at which the Gira G1 is activated from sleep mode when a hand approaches.

- 1 Tap the [Set proximity sensor] button.
- ✓ The [Set proximity sensor] page opens.

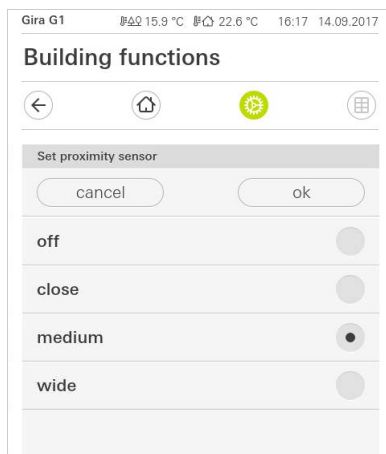

Figure 46
Set proximity sensor

- 2 Choose between the settings of the proximity sensor:
 - off (the proximity sensor is deactivated, i.e., the interface must be tapped to switch on the Gira G1),
 - close (the sensor reacts at a short distance),
 - medium (the sensor reacts at a medium distance),
 - wide (the sensor reacts at a long distance).
 - 3 Tap the [OK] button.
- ✓ The proximity sensor has been set. The system menu opens.

6.1.3

PIN protection

You can add PIN protection for the settings in the system menu. This protects the Gira G1 against unwanted changes. To activate PIN protection, proceed as follows:

- 1 Tap the [PIN protection] button.
- ✓ The [PIN protection] page opens.

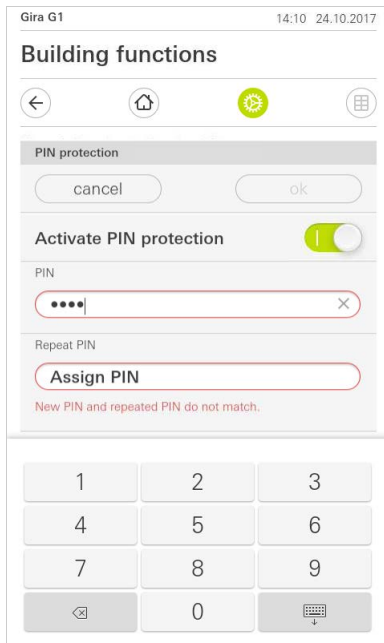

Figure 47
PIN protection

- 2 Slide the "Activate PIN protection" switch to the right.
 - 3 Enter a PIN in the upper box and repeat it in the second box.
 - 4 Confirm the entry with [OK].
- ✓ The system menu of the Gira G1 can now only be opened after the PIN is entered.

6.1.4

View configuration

In the view configuration, you define the functions displayed and the order of the functions for the action area.

- 1 Tap the [View configuration] button.
- ✓ The [View configuration] page opens.

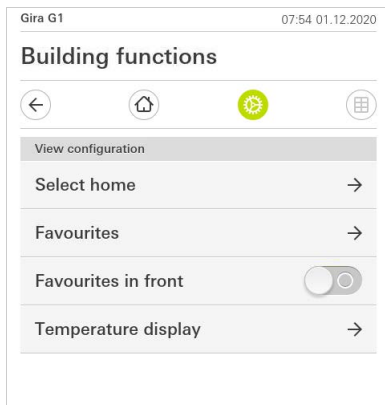

Figure 48
View configuration

- ✓ The following menu items are available:
 - Select Home [see 6.1.4.1]
 - Favourites with sub-items
 - Define favourites [see 6.1.4.2]
 - Sort functions [see 6.1.4.3]
 - Restore defaults [see 6.1.4.4]
 - Favourites in front [see 6.1.4.5]
 - Temperature display [see 6.1.4.6]

6.1.4.1

Select Home

Here you can define whether the Home view is displayed in tile or detail view when the Home button is tapped.

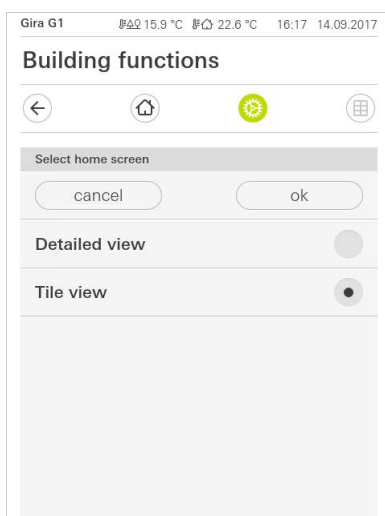

Figure 49
Select Home

- 1 Select the desired view for the Home view.
- 2 Tap the [OK] button.

6.1.4.2

Define favourites

You can select the functions to be displayed directly in the action area here.

- 1 Open the [View configuration] page.
 - 2 Tap the [Favourites] button, then tap [Define favourites].
- ✓ The [Define favourites] page opens and displays all the existing function folders.

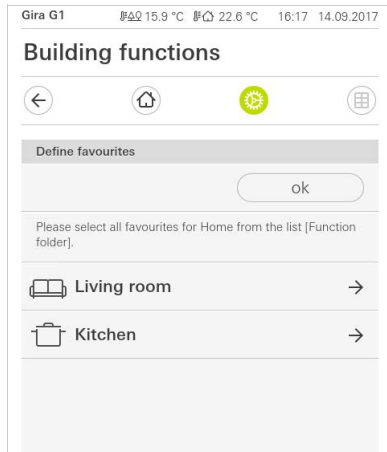

Figure 50
Define favourites

- 3 Switch to the function folder containing the function you want to display as a favourite.
- ✓ The [Define favourites, function folder] page opens.

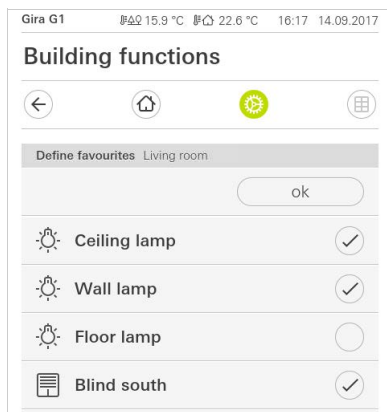

Figure 51
Select functions

- 4 Activate the functions that you wish to import as favourites.
 - 5 Tap [OK].
- ✓ The [Define favourites] page opens with the list of function folders.
- 6 Define additional favourites in the same way.
 - 7 When you are finished, tap [OK].
- ✓ The [View configuration] page opens.
- 8 Close and save your settings:
Tap [OK].
- ✓ A message informs you that changes have been made.
- 9 Confirm this by tapping [OK].
- ✓ The application on the Gira G1 restarts. The defined favourites then appear in the action area.

6.1.4.3

Sort functions

Here you can determine the order in which the functions and applications are displayed in the Home area of the Gira G1.

- 1 Open the [View configuration] page.
- 2 Tap the [Favourites] button, then tap [Sort functions].
- ✓ The [Sort functions] page opens and displays all the elements available on the Gira G1.

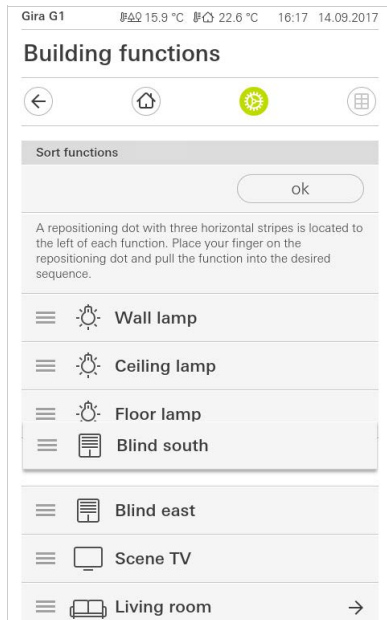

Figure 52
Sort functions

- 3 Place your finger on the shifting point of the desired entry and move the functions into the order you want.
- 4 Use the same method to move other entries.
- 5 When you are finished, tap [OK].
- ✓ The [Favourites] page opens.
- 6 Close and save your settings:
Tap [OK].
- ✓ A message informs you that changes have been made.
- 7 Confirm this by tapping [OK].
- ✓ The application on the Gira G1 restarts. The favourites then appear in the action area in the order defined by you.

6.1.4.4

Restore defaults

Here you can restore the action area view to the original state during configuration.

- 1 Open the [View configuration] page.
- 2 Tap the [Favourites] button, then tap [Restore defaults].
- ✓ A message appears asking whether you want to reset all settings to the original state at commissioning.
Confirm this by tapping [OK].
- ✓ The application on the Gira G1 restarts. The favourites appear in the action area in their original state at commissioning.

6.1.4.5

Favourites in front

This is where you can determine whether your favourites should be displayed on the home view.

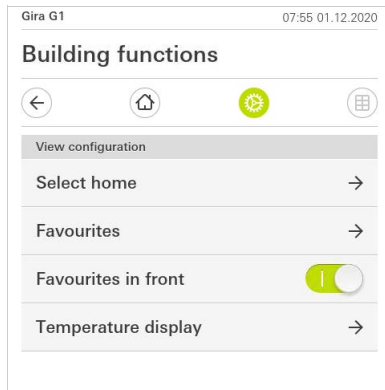

Figure 53

Favourites in front

- 1 Slide the slider switch to the right if the favourites functions should be displayed in front of other tiles, such as "Building", "Door communication" and "Weather forecast".

✓ Your favourites will be displayed first in the home view.

6.1.4.6

Temperature display

Here you can define whether the temperature should be displayed in the status bar. Two categories are available:

- Indoor temperature
The user can select enabled functions with the output of actual temperatures and the type "Status display Decimal".
- Outdoor temperature
The user can select enables functions of the type "Status display Decimal".

**Note****Selection of the correct data type**

Please note that data type (KNX) "9.001 Temperature (°C)" is used for functions that display temperature.

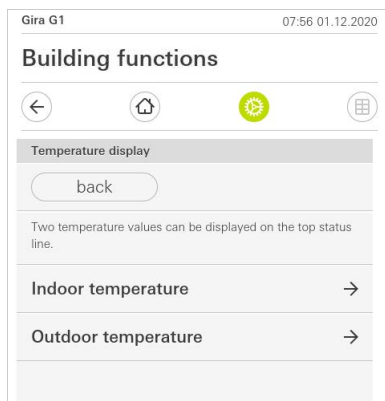

Figure 54

Temperature display

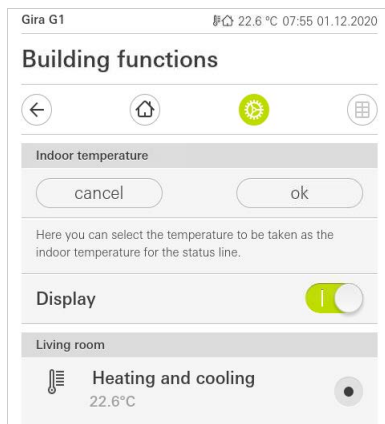

Figure 55
Select temperature

- 1 Push the sliding switch to the right to activate the display.
 - 2 Select one of the available temperature functions.
- ✓ The selected function is displayed in the status line.

6.2

Additional functions

The following functions are available under Additional functions:

- Select weather station [see 20]
- Occupied-home simulation [see 7.10]
- Timers [see 7.11]

6.3

Administrator functions

6.3.1

Manage rooms

- 1 Tap on the [Manage rooms] button in the system menu.
- ✓ The [Manage rooms] page opens.
- 2 Tap on the room that you wish to manage.
- ✓ You now have the option to rename the selected room and change the room's symbol.

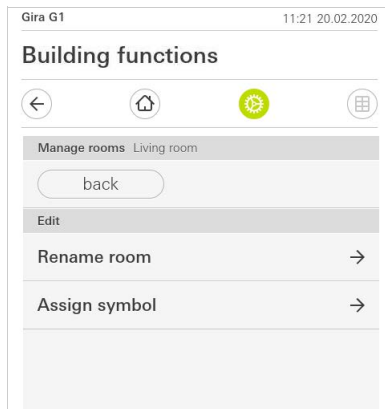

Figure 56
Manage rooms

6.3.2

Manage functions

- 1 Tap on the [Manage functions] button in the system menu.
- ✓ The [Manage functions] page is opened and you can select from the following options:
 - Create new function [see 6.3.2.1]
 - Manage function [see 6.3.2.2]

6.3.2.1 Create new function

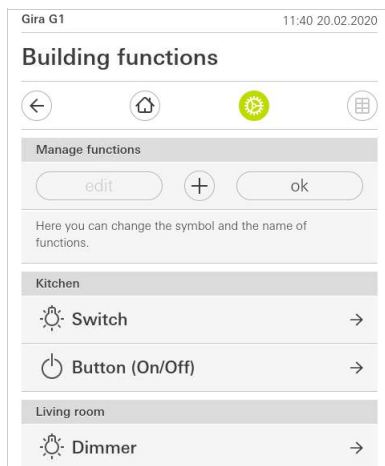

Figure 57
Create new function

- 1 Tap the [+] button.
- 2 Tap on the function that you wish to add.
- 3 Choose between the options:
 - Scenes [see 7.12]
 - Sonos audio control [see 7.13]
 - Philips hue lights [see 7.14]
 - IoT trigger (IFTTT) [see 7.15]
- 4 Follow the setup wizard by making your selection in the respective menu item and confirming it by tapping on [next].

6.3.2.2

Manage function

The change options offered depend on the functional scope of the selected function

- 1 Tap on the function that you wish to manage.
 - ✓ The following change options are now available to you:
 - Rename function
 - Assign symbol
 - Manage timer
 - Assign room
 - Assign subsection
 - Edit parameter

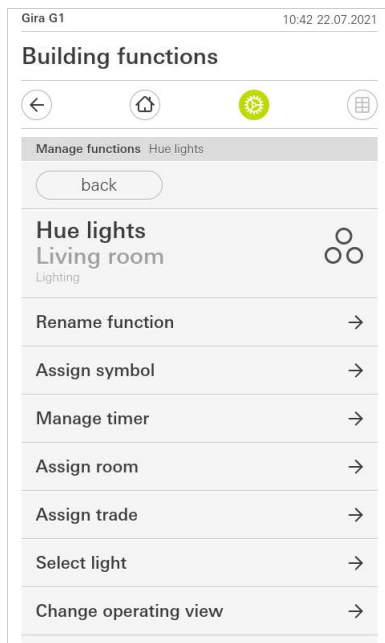

Figure 58
Manage function

6.3.3

Sort rooms/functions

- 1 Tap on the [Sort rooms/functions] button in the system menu.
- ✓ The [Sort functions] page opens.
- 2 Tap on the relevant function folder to sort functions within a folder.
- 3 Place your finger on the three horizontal lines in front of the function and drag them into the desired order.
- 4 Press to confirm your entry [Finish].

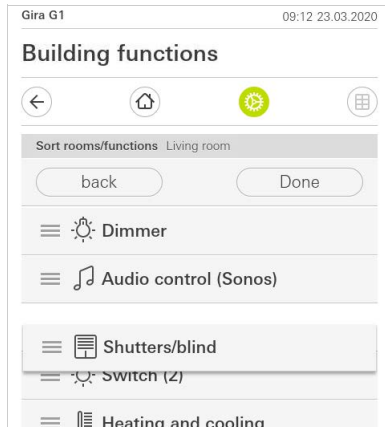

Figure 59
Sort rooms/functions

6.3.4

Manage subsections

- 1 Tap on the [Manage trades] button in the system menu.
- ✓ The [Manage trades] page opens.
- 2 Tap on the trade that you wish to manage.
- ✓ You now have the option to rename the selected trade and change the trade's symbol.

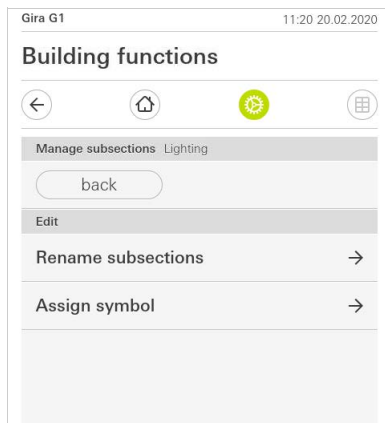

Figure 60
Managing trades

6.3.5

Manage users

You have the option of creating new users or managing existing users.

- 1 Tap on the [Manage users] button in the system menu.
 - 2 You can now add a new user with the [+] button or tap [edit] to delete users.
 - 3 In order to manage users, tap on the respective user name.
- ✓ The following menu items are available:
- Rename users [see 6.3.5.1]
 - Change login data [see 6.3.5.2]
 - Select functions to be enabled [see 6.3.5.3]
 - Take over functions to be enabled from... [see 6.3.5.4]

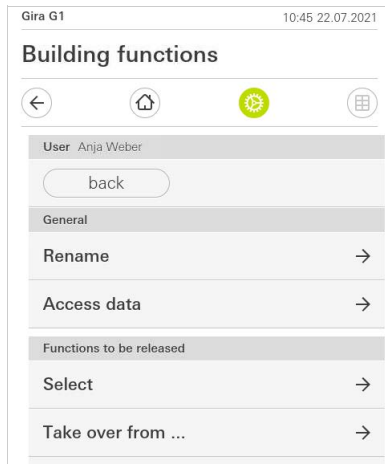

Figure 61
Manage users

6.3.5.1

Renaming users

- 1 Tap [Rename].
 - 2 Change the displayed name and tap the [OK] button in order to confirm.
- ✓ The user name has been changed accordingly.

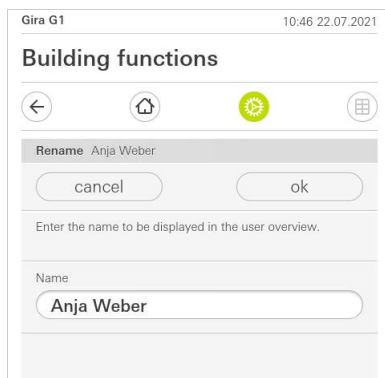

Figure 62
Rename
users

6.3.5.2

Change login data

1 Tap [Login data]

✓ The following menu items are available to you:

- Display user name
- Reset password

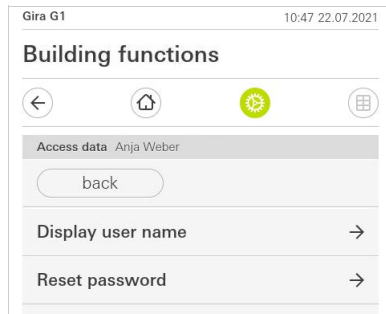

Figure 63

Change login data

Proceed as follows in order to reset a user's password and assign a new one:

- 1 Enter your own administrator password.
 - 2 Enter a new password for the selected user.
 - 3 Re-enter the new password.
 - 4 Tap the [OK] button in order to confirm.
- ✓ The selected user's password has been changed.

6.3.5.3

Select functions

You have the option of enabling or disabling functions for individual users. You can select functions by buildings or trades.

- 1 Tap on the check mark after [Authorise everything].
- ✓ If the check mark is removed, all the functions for the building section or trade are blocked for the user concerned.
- 2 Tap on the horizontal arrow after the room or trade concerned to authorise or block individual functions.
- ✓ The number combination beneath the building or trade displays the number of available/authorised functions.

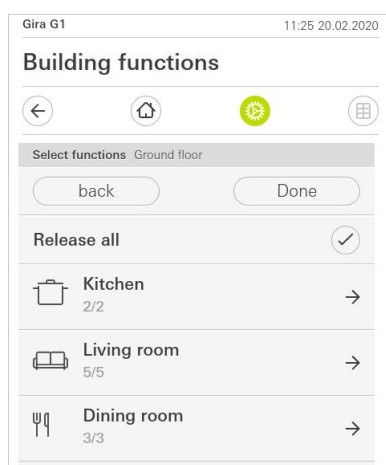

Figure 64

Select functions

6.3.5.4

Take over functions

You have the option to apply other users' authorisation settings.

- 1 Tap on the user whose authorisation settings that you wish to apply.
 - 2 Tap on [OK] in the confirmation dialogue.
- ✓ The selected user's authorisation settings are applied.

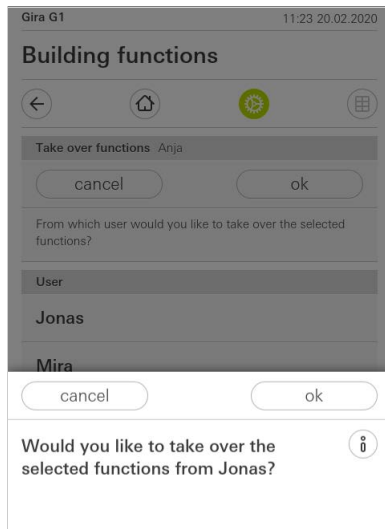

Figure 65
Take over functions

6.4

Information

The following functions are available in the Information area:

- License agreement
This is where the license agreements for the Gira G1 are displayed.
 - Gira app version ...[see 6.2.1]
-

6.4.1

Gira app version

This area provides you with information on the installed and potentially available versions of the Gira Smart Home app:

- Installed version
Here you will see the currently installed version of the Gira Smart Home app installed on the Gira G1.
- Available versions
If an update is available for the Gira Smart Home app, it will be displayed here. To install the app update, simply tap the new version.

7

Operating the Gira X1 Client

7.1

Status bar

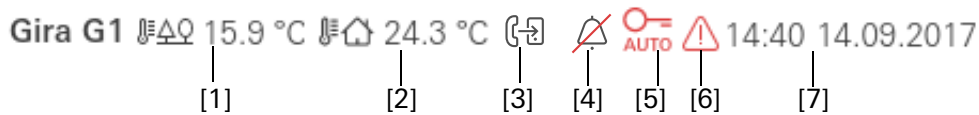

Figure 66

Gira G1 status bar

The symbols in the status bar have the following meanings:

- [1] Display of the outdoor temperature in degrees Celsius (°C). The values for the outdoor temperature can be obtained from configured functions of the type "Status display decimal".
- [2] Display of the room temperature in degrees Celsius (°C). The values for the room temperature can be obtained from configured functions with the output of actual temperatures.
- [3] The display shows that forwarding is active in the "Door communication" application.
- [4] [Ring tone off] appears if the ring tone has been switched off in the "Door communication" application.
- [5] [Automatic door opener] appears when automatic door opening has been activated.*
- [6] The warning symbol in the status bar shows that the Gira G1 is no longer functioning.
If you tap the warning symbol, the relevant error message is displayed.
- [7] Time and date display.

*only displayed when using the Gira door communication system.

7.2

Navigation bar



Figure 67

Gira G1
navigation bar

The buttons in the navigation bar have the following functions:

- [1] [Back] opens the previously opened page.
- [2] [Home] opens the home page of the action area.
- [3] [System] opens the [Settings] view.
- [4] [Change view] switches between tile and detail view.

**Note**
Differences in the following views

All figures in the tile or detail views in this document may differ from the views in your project, as the texts, functions and symbols can all be configured as desired. Accordingly, this document refers only to the basic functions. A tiled or detailed view is available for each function. You can change to the detailed view of the function by tapping the tile.

7.3

Direct function

The "Palm operation" gesture activates the direct function. By placing the palm of your hand on the display, you can directly access a predefined main function. In this way, the Gira G1 becomes a simple switch with which the ceiling lamp can be switched on and off, for example. The main function is superimposed over the screen that is currently active and automatically disappears again after a certain period of time.

"Palm operation"

The function that is to be triggered using the direct function can be defined in the system menu [see 6.1.1].

7.4

Tile view

Tile view is one of the two view options of the action area, along with detail view. All the building functions can be displayed here as tiles. In addition, individual functions can be bundled in a function folder, e.g. for all functions in one room.

You can display up to six small tiles in the tile view.

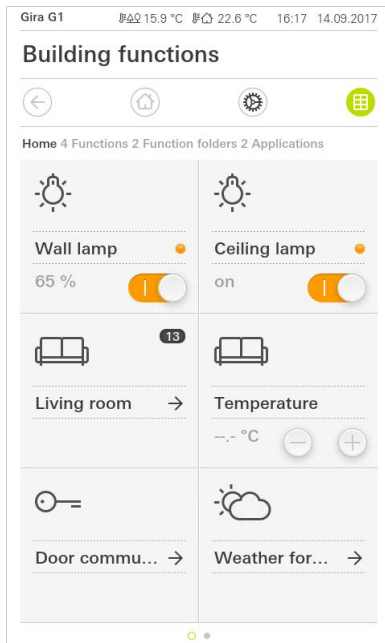

Figure 68
Example
Tile view

Central functions such as switching on and off, setting the temperature, or dimming in fixed steps can be operated directly within this view. To do this, tap Plus/Minus or the arrow buttons to dim the light, adjust the temperature or move blinds/shutters.

Operation in tile view

When you tap a tile, the detail view of the function opens. There (depending on the configuration) you can carry out additional operations in the function.

7.5

Detail view

Detail view is one of the two view options of the action area, along with tile view. Detail view is opened by tapping a tile in tile view. All operating elements of the relevant function are then available on the entire display. Operation for most functions is by tapping, with some functions, such as the blind control, distinguishing between a short and long press of the button.

You can switch from one function to the next with a horizontal swiping movement of the finger.

Horizontal swiping

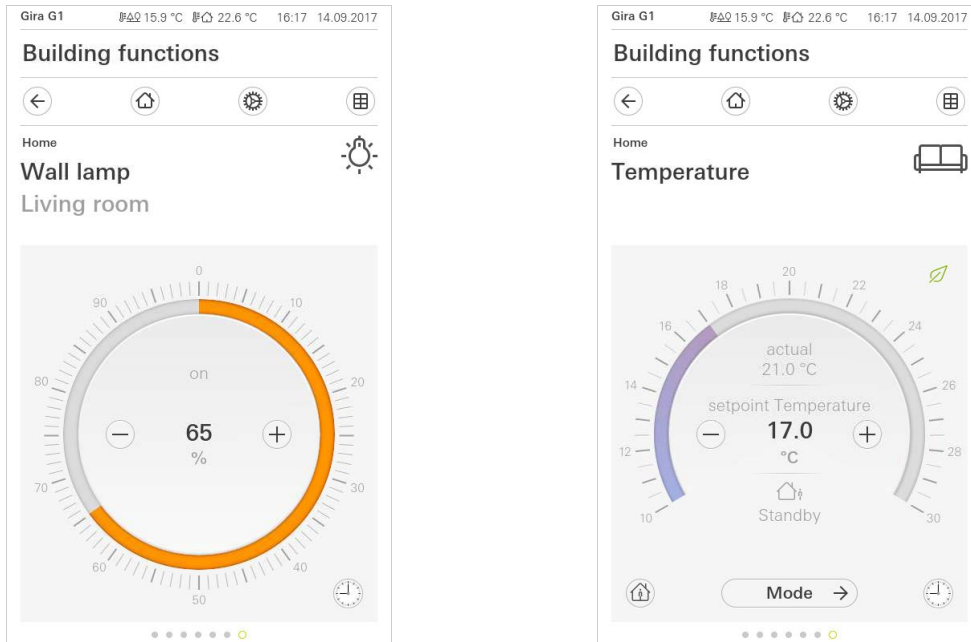

Figure 69
Example
Detail view

The adjustable scale can be used in the [Dimmer] and [Heating] functions. In order to adjust e.g. the brightness or setpoint temperature, tap directly on the desired value in the scale or move the adjustable scale to the desired position.

Adjustable scale

Note
Hold finger on start position

Before moving the finger, briefly rest it (approx. 1 s) on the start position of the scale to allow the Gira G1 to carry out the position correction.

Blinds or shutters can be controlled using the slide control in the detail view. To move blinds or shutters up or down or adjust the slats, slide the controller to the desired position.

Blind/shutters
Operation using slide control

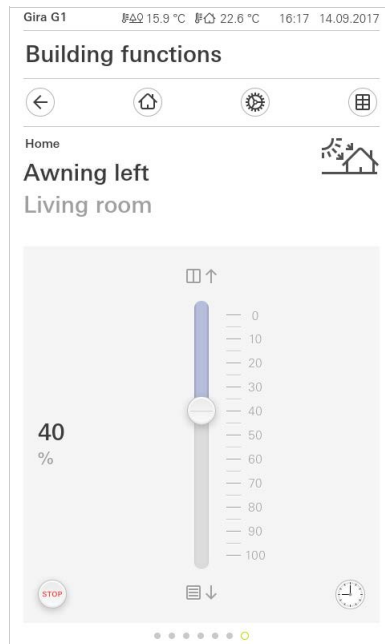
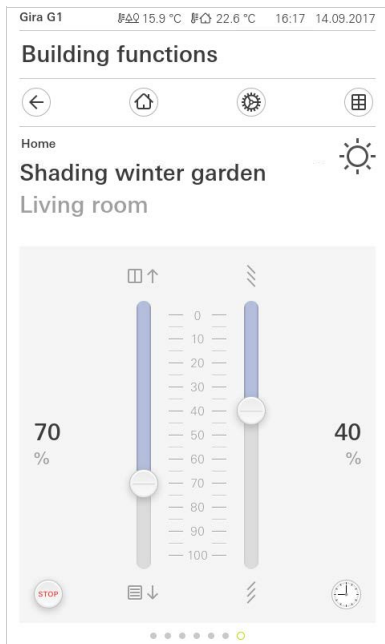

Figure 70
Detail view
Operation using
slide control

When you tap the [STOP] button, you can directly stop active movement of the hanging or a slat adjustment. The hanging then stops immediately at its current position.

Stop button

7.6

Scene auxiliary unit

A scene is a grouping of actions which are always carried out together. This means, for example, that specific preferences are stored for any situation in a room, and these presets can be called up at the push of a button. This allows you to create the "TV" scene, for example, and to activate it with a function of the Gira G1. If this scene is activated, the blinds move to a certain position, the lighting is dimmed to a defined value, the screen is lowered and the projector switched on.

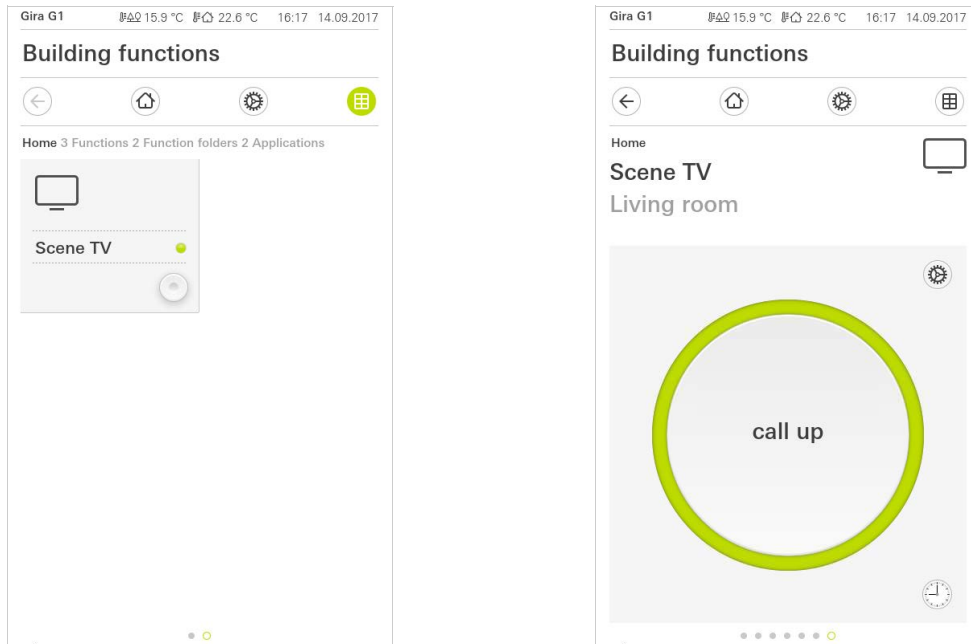

Figure 71
Scene auxiliary unit
Left: Tile view
Right: Detail view

In detail view, a save telegram for the scene can be triggered to save new values for the functions of the scene.

Save scene

Note Assign functions of a scene in the GPA

Functions (e.g. lights, blinds or shutters) must have been assigned during configuration of a scene.

By saving a scene, previously saved values of a scene are overwritten.

If you want to save new values for the functions present in a scene:

- 1 Tap the [Settings] button in the detail view of the scene.
- ✓ The [Set scene] page opens.
- 2 Set all the devices assigned to this scene as desired (e.g. brightness value, blind position). When the scene is activated, these devices will be operated with those values.
- 3 Tap the [Save scene] button.
- ✓ A note appears.
- 4 Tap the [OK] button.
- ✓ The [Set scene] page opens. The scene has been saved.

7.7

Room temperature presence button and mode

The presence button can be used to activate the comfort temperature from night mode or frost/heat protection. This function can be used to raise the room temperature to the comfort temperature for a period of time if the room is used during night time hours as an exception (e.g. for a party).

If the presence button is pressed in standby mode, the comfort mode is switched on indefinitely.

You can use the [Mode] button to switch between various operating modes ("Comfort", "Night", etc.) to which different setpoint temperatures are assigned.

- 1 To switch operating mode, tap [Mode].
- ✓ The operating mode page opens.

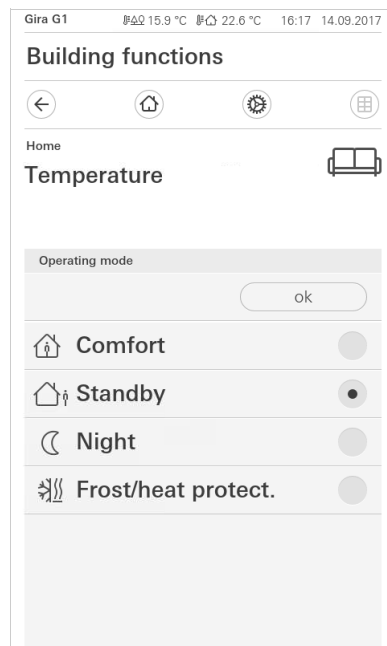
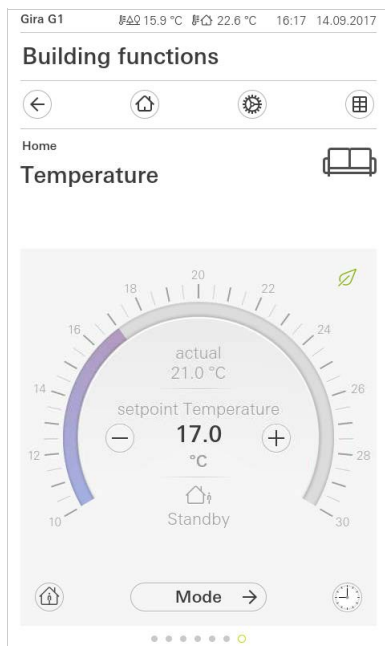

Presence button
(comfort extension)

Changing the mode

Figure 72
Switching operating mode

- 2 Select the desired mode and confirm with [OK].
- ✓ The detail view of the heating function is displayed. The desired mode has been set.

The various modes have the following meanings:

- **Comfort**
Comfort mode is activated if people are in a room and the room temperature is to be set to a comfortable value.
- **Standby**
Activate standby if a room is not used during the day. This adjusts the room temperature to a standby value, enabling heating or cooling energy to be saved.

-
- **Night**
Activate night mode during night hours or during a long absence. This adjusts the room temperature to cooler temperatures in heating systems (e.g. in bedrooms). In this case, cooling systems can be set to higher temperature values when air conditioning is not necessary (e.g. in offices).
 - **Frost/heat protection**
Frost protection is required when, for example, the room temperature is not to fall below critical values when a window is open. Heat protection may be necessary when the temperature becomes too high due to external influences. In these cases, freezing or overheating of the room can be prevented by specifying an individual temperature setpoint by activation of the frost/heat protection, depending on the "Heating" or "Cooling" operating mode.
-

7.8

Timer

The timer is easy to operate and can be used to control many functions. It allows certain functions to be triggered at a specified time every day or only on certain days. For example, the blinds are automatically raised every morning and lowered again in the evening, or the heating automatically switches to night mode.

A timer can be set up in the following functions:

- Switching and pressing (on/off) with 10 switching times
- Dimming with 10 switching times
- Blind/shutter functions with 10 switching times
- Value transmitter with 10 switching times
- Scene auxiliary unit with 10 switching times
- Air-conditioning system with 10 switching times
- Temperature controller and sauna function with 28 switching times

7.8.1

Creating a switching time

- 1 Tap the [Timer] button in the detail view of the relevant function.
- ✓ The [Timer overview] page opens.

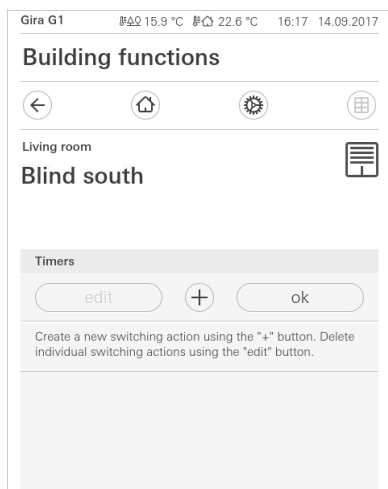

Figure 73
Overview
Timer

- 2 Tap the [+] button.
- ✓ The [Timer] page opens.

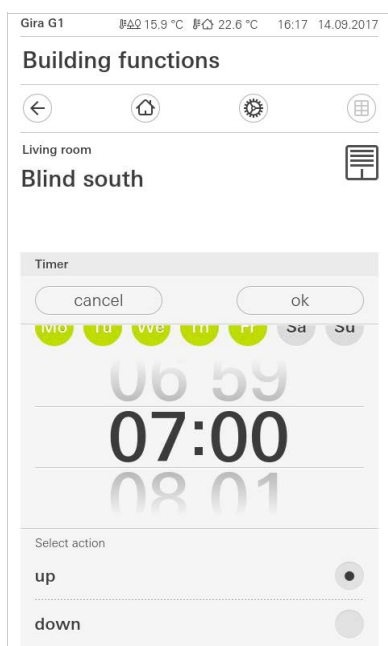

Figure 74
Creating a switching
time

- 3 You can activate or deactivate the days on which the timer is to apply with a finger tap. Days on which the timer is active are marked green.
- 4 Select one of the three possible switching times when the action should be performed:

- Configure a time when the action should be performed.

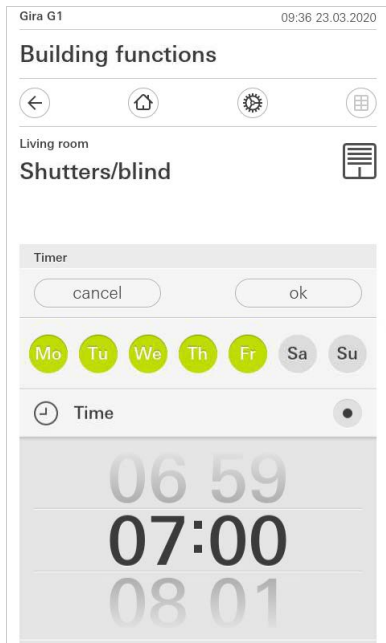

Figure 75
Set time

- Sunrise
 - Activates the switching time at the point in time when sunrise is calculated to take place. You also have the option to activate a time limit under "Set earliest/latest".
 - "Earliest" activates the switching time at sunrise but not before the time that you entered.
 - "Latest" activates the switching time at sunrise or before the time that you entered here at the latest.
 - "Change sunrise time" allows you to shift the switching time by up to 120 minutes before or after the point in time for the calculated sunrise.

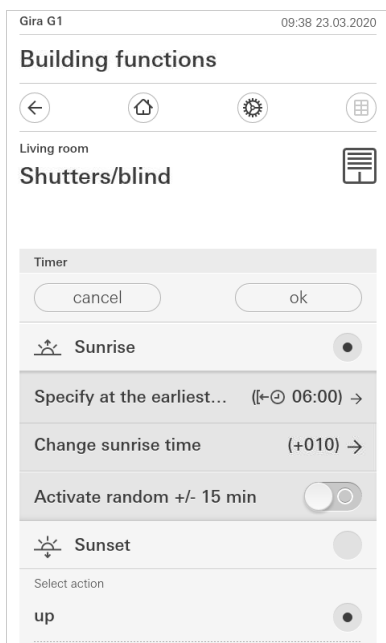

Figure 76
Sunrise
Activate

- **Sunset**
 Activates the switching time at the point in time when sunset is calculated to take place. You also have the option of activating a time limit under "Set earliest/latest".
 "Earliest" activates the switching time at sunset but not before the time that you entered.
 "Latest" activates the switching time at sunset or before the time that you entered here at the latest.
 "Change sunset time" allows you to shift the switching time by up to 120 minutes before or after the point in time for the calculated sunrise.

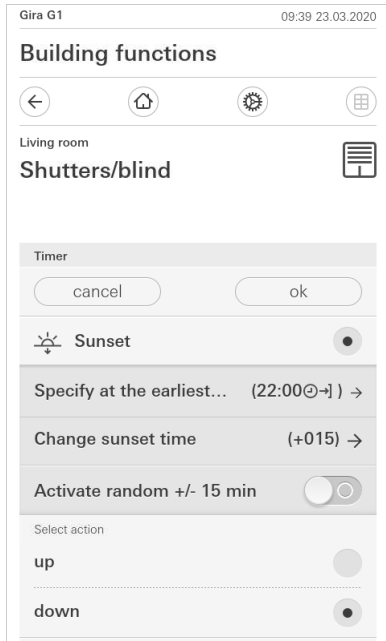

Figure 77
 Sunset
 Activate

- 5 You can increase or decrease the switching times by up to 15 minutes using a random component. To do so, move the [Activate random +/- 15 min.] slider switch to the right.

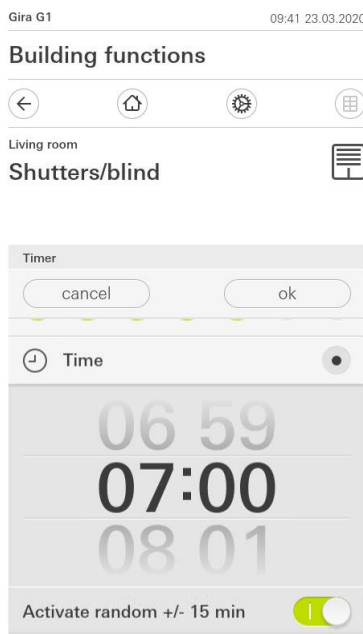

Figure 78
 Random function
 Activate

-
- 6 Under "Select action", choose the function to be set up. The type of value that can be selected here depends on the function to be set up.
 - 7 Tap the [OK] button.
- ✓ The timer is set.
-

7.8.2

Deleting a switching time

- 1 Open the [Timer overview] page.
 - 2 Tap the [Edit] button.
 - 3 Mark the switching time to be deleted.
You can also mark and delete several switching times here.
- ✓ A red tick appears in front of the switching time. The red [Delete] button is shown.
- 4 Tap the [Delete] button.
- ✓ The [Timer overview] page opens. The marked switching time is deleted.

7.8.3

Activating and deactivating all switching times for a function

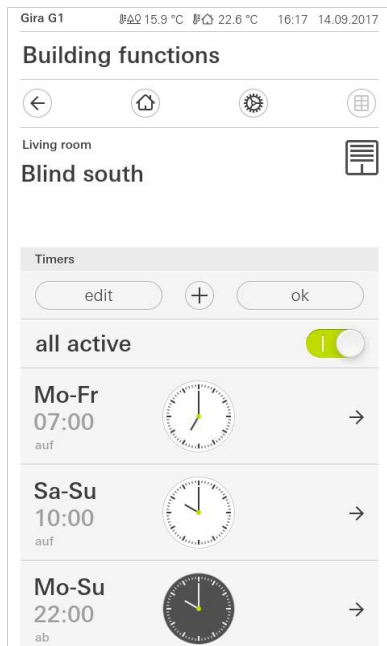

Figure 79
Activating/deactivating all switching times

- 1 Set the switch [Activate all] to [I] to activate or to [O] to deactivate.
 - 2 Tap the [OK] button.
- ✓ The function from which you switched to the [Timer overview] page opens.
All switching times for this function are activated or deactivated.

Tip
Temporarily deactivating switching times

If you want to temporarily deactivate individual switching times for a function, you can simply deactivate all days (set to grey).

7.9
Function folder

Functions are stored in function folders. Individual functions can be bundled in a function folder, e.g. all the light functions, to provide a better overview. Function folders also offer the possibility of mapping a simple building structure, e.g. all functions in a room.

A function folder can contain a maximum of 25 functions.

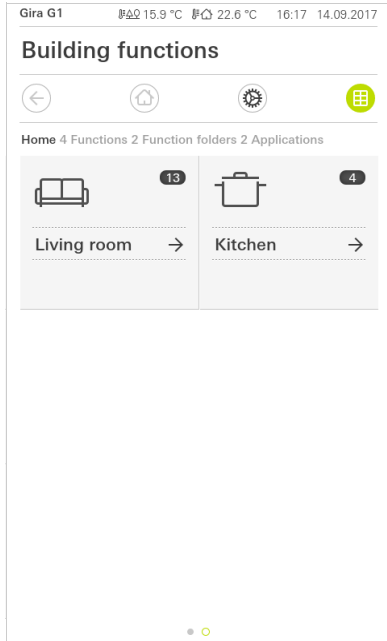

Figure 80
Function folder

7.10
Occupancy simulation

With occupancy simulation, you record selected building functions that are later played back automatically. This perfectly simulates the real usage of your building, making it look occupied, e.g., when you are on holidays.

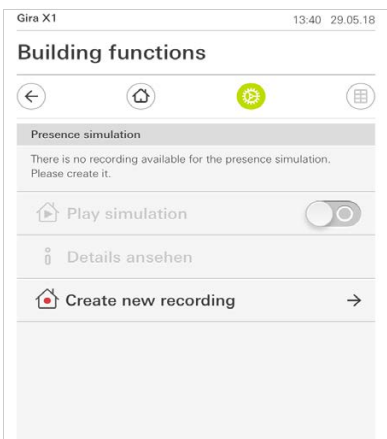

Figure 81
Occupancy simulation

7.10.1

Recording a simulation

Before you can use the simulation function, the building functions to be played during your absence have to be recorded for 7 days. For this, please proceed as follows:

- 1 Open the [Occupancy simulation] page.
 - 2 Tap [Create new recording].
 - 3 Tap [Select functions] and select the functions to be recorded and played in the later simulation.
These functions should of course be visible from the outside, e.g., light functions or moving blinds or shutters if these are not controlled by timers.
 - 4 Confirm the selected functions with [OK].
You can then view the functions again, and change them if necessary.
 - 5 When you have selected all the functions, activate recording by sliding the [Record] slider switch to the right.
- ✓ The recording starts and ends automatically after 7 days.
-

7.10.2

Playing a simulation

A prerequisite for playing back the occupancy simulation is that you have recorded the functions for 7 days beforehand.

- 1 Open the [Occupancy simulation] page.
 - 2 Start the occupancy simulation by sliding the [Play simulation] slider switch to the right.
- ✓ The occupancy simulation is played until it is deactivated again by the slider switch.

7.11 Timers

The Timers menu shows you an overview of all configured functions for which a function timer can be created.

Prerequisite:

The “Display function time” parameter must have been selected for the respective function during configuration in the Gira Project Assistant.

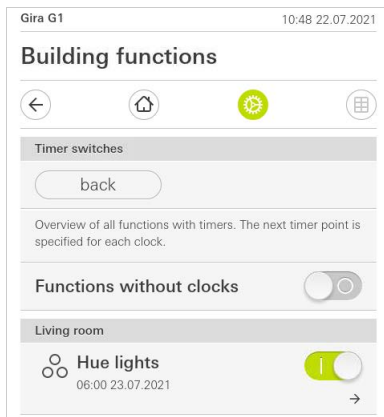

Figure 82
Show function timer

You can use the slider switch “Functions without timers” to adjust the view:

- Slider switch to the left [O]: Functions with configured function timers are shown.
- Slider switch to the right [I]: All functions are shown.

Tap the individual functions to create, edit or delete new function timers.

Note Activate / deactivate function timers

If you created several function timers for a given function, only the next switching time is displayed in this menu. The function’s slider switch is nevertheless used to activate/deactivate all function timers created for this function.

7.12 Scenes

Proceed as follows to set up scenes in the Gira Smart Home app:

- 1 Tap on the [Manage functions] button in the system menu.
✓ The [Manage functions] page opens.
- 2 Tap the [+] button.
✓ The [Create new function] page opens.
- 3 Tap [Scenes].



Bild 83
Scenes

- 4 Select one of the two options
 - [New scene], to create a scene
 - [Scene variant], to create a variant of an existing scene.
- 5 Follow the setup wizard.

7.13

Sonos audio function

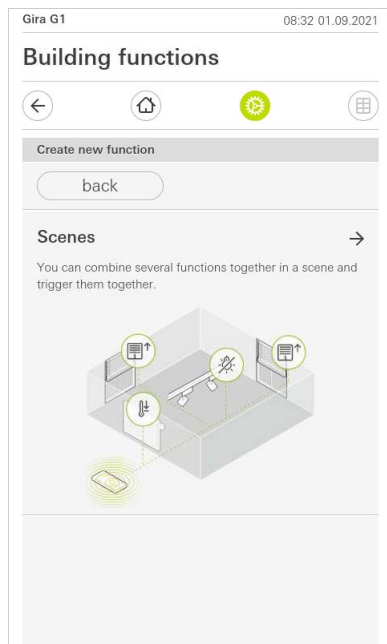
You can control the Sonos sound systems via the Gira Smart Home app using the "Sonos audio" function.

The following functions are available: Play/pause track, change volume, mute, switch between tracks (previous and next track), display track, artist, album and playlist and change playlists (previous and next playlist).

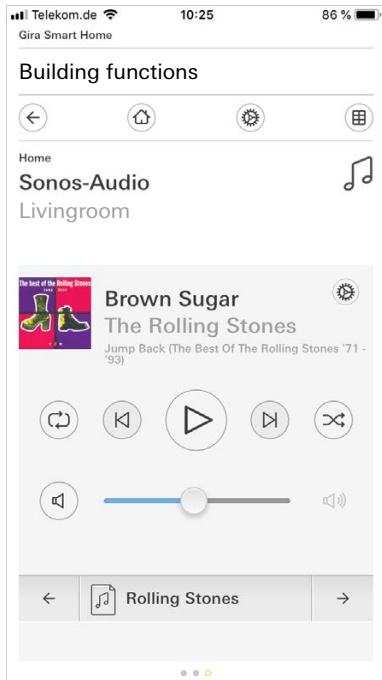

Figure 84
Sonos audio

7.13.1

Configuring the Sonos audio function

Proceed as follows to set up Sonos audio on the Gira G1:

- 1 Tap on the [Manage functions] button in the system menu.
✓ The [Manage functions] page opens.
- 2 Tap the [+] button
✓ The [Create new function] page opens.
- 3 Tap on [Sonos audio control]

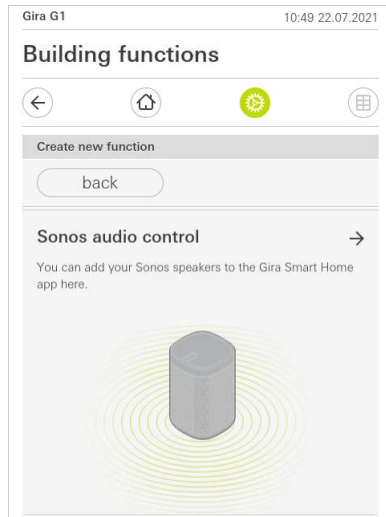

Figure 85
Configuring
Sonos audio

- 4 Select the Sonos device you wish to use for playback and follow the setup wizard.

Note
Number of Sonos devices

You can configure a maximum of eight Sonos devices on the Gira X1 client. The group master is displayed if multiple Sonos devices are brought together in a group using the Sonos app.

7.13.2

Change Sonos loudspeaker

- 1 Tap on the cog wheel symbol within the Sonos application.
- ✓ The [Settings] page will open.
- 2 Tap on [Change Sonos loudspeaker].
- 3 Select the Sonos device you wish to use for playback.

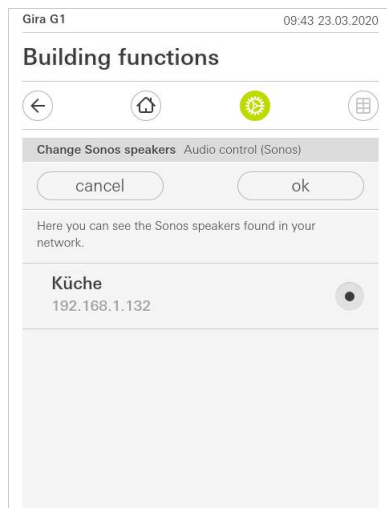

Figure 86
Change Sonos loud-
speaker

Note
Number of Sonos devices

You can configure a maximum of eight Sonos devices on the Gira X1 client. The group master is displayed if multiple Sonos devices are brought together in a group using the Sonos app.

7.13.3

Configuration of the favorites

You can create favourites (“My Sonos”) in the Sonos app. These Sonos favourites are automatically added to the Gira X1 client (in alphabetical order), where they can then be used.

You do have the option of changing the order of favourites for the Gira X1 client. You can do so on the Gira X1 device website:

- 1 Open the Gira X1 device website:
To do so, open Windows Explorer on your PC and open the “Network” folder. Double-click on Gira X1 in this folder.
- 2 Enter the details for the login:
You can log in with one of the four user accounts: “Device”, “Administrator”, “Electrician” or “User”. To log in, click on the required button and enter the corresponding access data.
If you click on “Device”, the user name is “device” and the password is the device password.
If an administrator, an electrician or a user with the Administrator role were added when the Gira X1 was configured, you can also use these access data to access the device website.
- 3 Select the “Sonos favourite assignation” view on the page which opens up.
- 4 Select the corresponding Sonos device in the “Select Sonos loudspeaker” drop-down menu.
- 5 Click on a memory space in the list to establish or change a favourite. A total of 255 memory spaces are available.

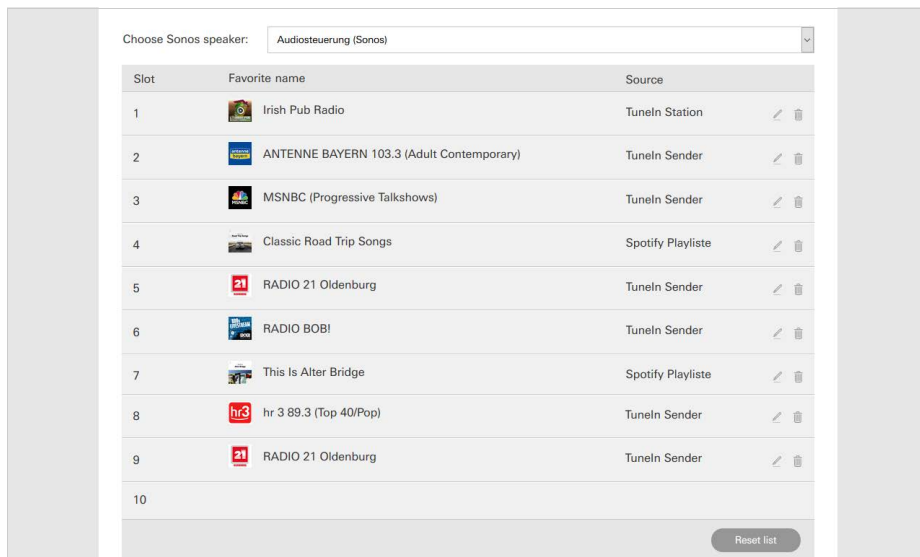

Slot	Favorite name	Source	
1	Irish Pub Radio	Tuneln Station	✎ 🗑
2	ANTENNE BAYERN 103.3 (Adult Contemporary)	Tuneln Sender	✎ 🗑
3	MSNBC (Progressive Talkshows)	Tuneln Sender	✎ 🗑
4	Classic Road Trip Songs	Spotify Playliste	✎ 🗑
5	RADIO 21 Oldenburg	Tuneln Sender	✎ 🗑
6	RADIO BOB!	Tuneln Sender	✎ 🗑
7	This Is Alter Bridge	Spotify Playliste	✎ 🗑
8	hr3 hr 3 89.3 (Top 40/Pop)	Tuneln Sender	✎ 🗑
9	RADIO 21 Oldenburg	Tuneln Sender	✎ 🗑
10			

Figure 87
Sonos
Favourite assignation

7.13.4

How favourites behave after the memory function has been used

If you have edited and saved the Sonos favourites list on the device website, the entries in the list will no longer be updated automatically. In other words, if you change favourites on the Sonos app, these changes are not automatically adopted in the Gira X1 client.

This has the advantage that the assignment of a Sonos favourite to a KNX touch sensor is not changed inadvertently by adding a favourite in the Sonos app, for example.

If you need to add a favourite from the Sonos app to the Gira X1 client's saved list, you must add it on the Gira X1 device website.

7.13.5

Which errors may occur?

If you have accidentally deleted a Sonos favourite that can be accessed using a push button sensor in the Sonos app, the button on the push button sensor no longer has any function.

In such a case, open the Gira X1 device website (see above) and add a new Sonos favourite in the deleted favourite's space.

7.14

Philips Hue lights

Proceed as follows to add Philips Hue lights to the Gira Smart Home app:

- 1 Tap on the [Manage functions] button in the system menu.
✓ The [Manage functions] page opens.
- 2 Tap the [+] button.
✓ The [Create new function] page opens.
- 3 Tap [Philips Hue lights].



Bild 88
Philips Hue

- 4 Select Philips Hue lights, rooms or zones created in the Philips Hue app and follow the setup wizard.

7.15

IoT trigger (IFTTT)

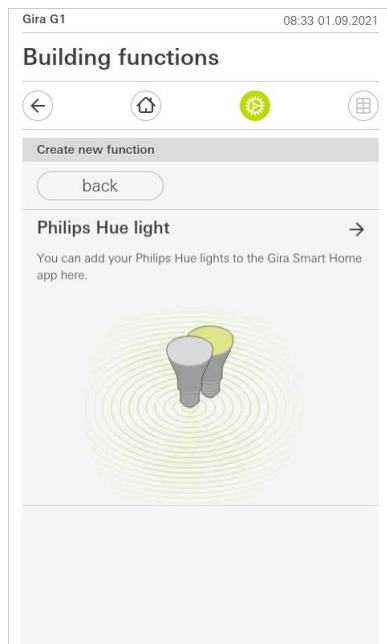
Under “Manage functions” [see 6.3.2] you have the option of creating a IoT trigger (IFTTT).

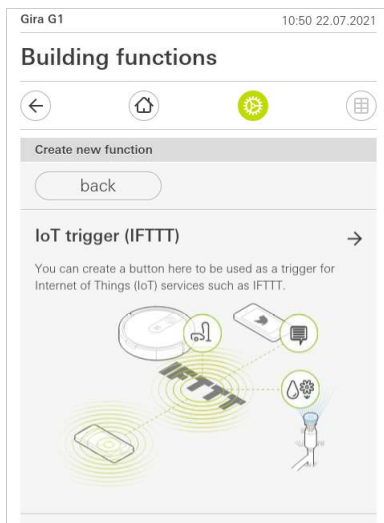

Figure 89
IoT trigger (IFTTT)

To be able to use the IFTTT service, you need the following

- an IFTTT account,
- access to the Gira device portal,
- and a fully set-up remote access module (e.g. Gira S1).

Proceed as follows to connect the Gira X1 to the IFTTT:

- 1 Open <https://ifttt.com/gira> in your browser.
- 2 Log in to your account or create a new one.
- 3 Click on “Connect” in your account and enter your access data for the Gira device portal.
- 4 In the installation wizard, then specify the remote access module (e.g. Gira S1) and Gira X1 you have.
- 5 Enter the access data for your Gira X1.

The last step is to confirm the connection between your Gira X1 and IFTTT. You can now create your own if/then rules.

7.16

Remote access

If you require remote access to the Gira X1 via the Gira S1, you must first configure remote access in the Gira device portal and in the Gira Project Assistant.

You can visualize remote access on the Gira G1.

Prerequisite:

- The S1 has been situated in the building structure in the Gira Project Assistant.
- The "Remote access" function has been configured in the Gira Project Assistant under "Visualization".

In the visualization of the remote access you can control the remote access and display its status:

- Remote access in detail view [see 7.16.1].
- Remote access in tile view [see 7.16.2].

7.16.1

Remote access in detail view

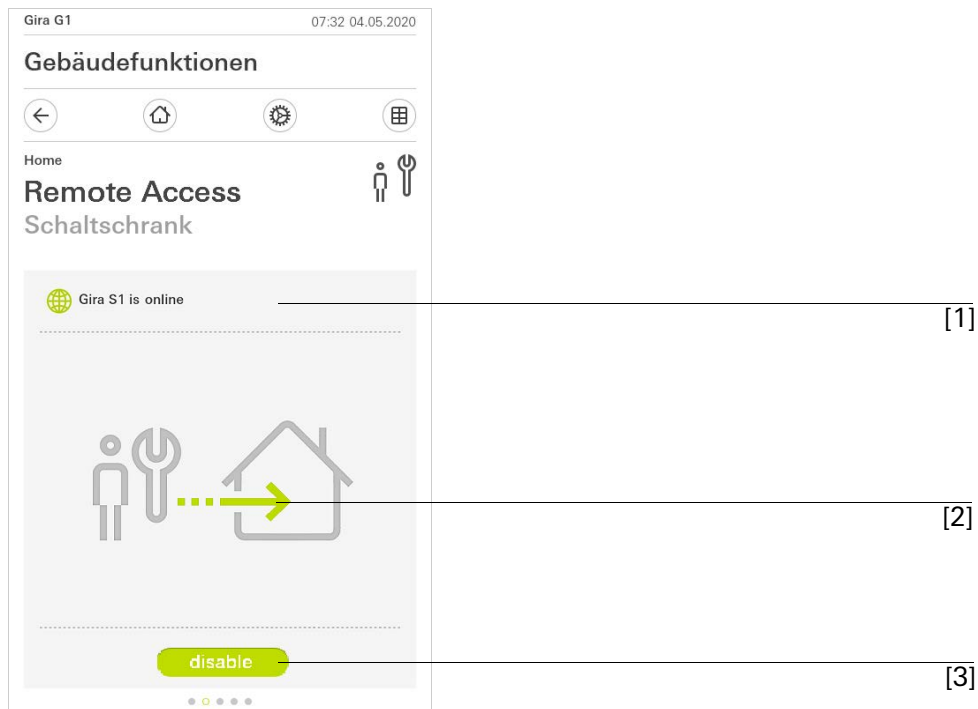
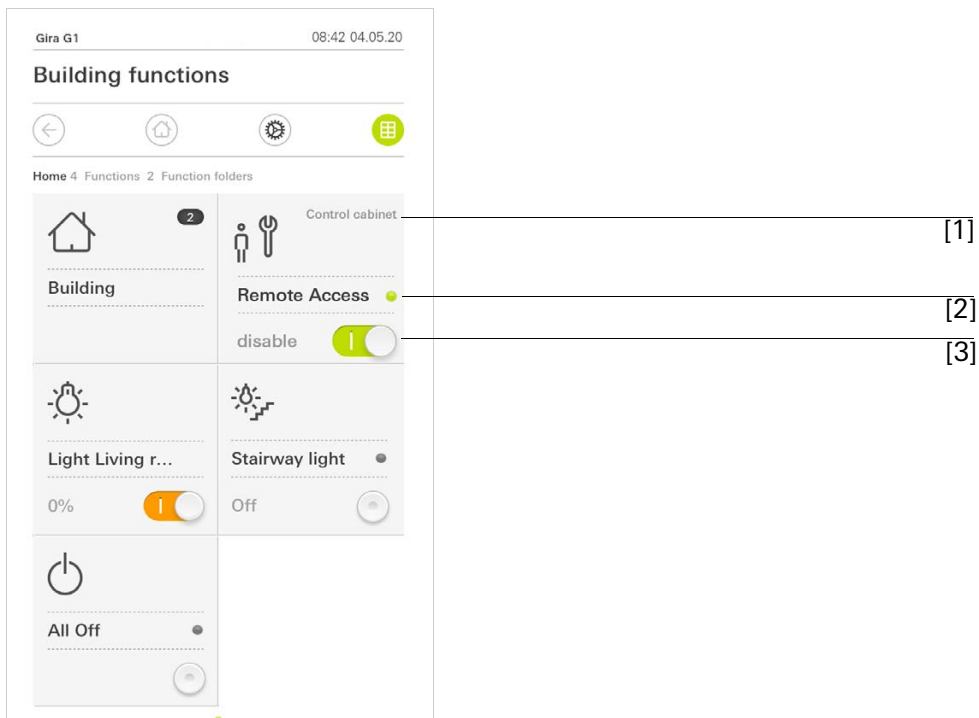

Figure 90
Remote access -
detail view

- [1] Display whether the Gira S1 is online.
 [2] Display whether remote access is in progress.
 [3] Button to enable/disable remote access.

7.16.2

Remote access in tile view

**Figure 91**

Remote access - tile view

[1] Display in which part of the building the "Remote Access" function was configured.

[2] Display whether remote access is in progress.

[3] Sliding switch to enable/disable remote access.

Configuration of Gira G1 in the GPA

You can configure the Gira G1 in the Gira Project Assistant (GPA) and combine it with other Gira products, such as Gira X1 or Gira L1.

Gira G1 provides device data points that can be used in the GPA of Gira X1 and Gira L1.

The possible applications in combination with the device data points are described below. The corresponding data point types and value ranges as well as commissioning of the Gira G1 via the GPA are explained in the GPA Help.

Gira G1 device status

Ready	Provides information on the readiness status.
Status	Provides information about the current status of the Gira G1.
Restart	Allows triggering of a restart.
Local time	Sends the current date of the Gira G1.
System time	Sends the current system time of the Gira G1.
Operating time	Sends the operating time since the last device startup

Proximity sensor

Status	Indicates whether the proximity sensor was triggered.
--------	---

Brightness sensor

Value	Provides the current reading of the brightness sensor.
-------	--

LED

Value	Allows simultaneous control of all LEDs of the Gira G1.
Red	Controls the red LED
Green	Controls the green LED
Blue	Controls the blue LED

Temperature

Room temperature	Provides the value of the Gira G1 temperature sensor for display in the Gira G1 status bar or for transmission to other Gira devices (such as Gira X1 or Gira L1) and applications.
Received Outdoor temperature	Allows display of outdoor temperature received from a weather station, for example, in the Gira G1 status bar.

Display

Lock	Locks the Gira G1 display to prevent inadvertent activation or unauthorised use.
Message text	<p>Allows sending of messages in JSON format to the Gira G1.</p> <p>The message consists of the title, the message text and the time and date.</p> <p>If a message was initiated, it must first be acknowledged before further actions can be executed on the Gira G1 display. If a message is displayed on more than one Gira G1 device, it must be acknowledged on each device.</p> <p>Each device has a capacity of 20 messages. Starting with message 21, the oldest message is deleted.</p>

Touch sensor

Status	Sends a notification of status changes in the touch sensor. For example, whether the Gira G1 display is currently being touched or let go of.
--------	---

Ring tone

Mute	Mutes the ring tone on the Gira G1.
------	-------------------------------------

Door communication

Status	Allows access to the display channel of the door communication, for example to use the door communication status to trigger additional events in the system.
Call button text	Displays the name of the button that triggered the door call.
Floor call Designation	Displays the name of the button that triggered the floor call.

Settings

Execute	Allows initiation of calls, playback of ring tones, changing the loudness and setting the ring tone and door opener code of contacts.
---------	---

Floor call

Trigger	Allows triggering of the floor call.
---------	--------------------------------------

Loudness of floor call

Value (1...100)	Allows setting of the floor call loudness.
-----------------	--

Configuring the Alarm Connect security system

The following prerequisites must be fulfilled for commissioning to be successful:

- The Alarm Connect security system must be configured to be functional.
- When configuring the security system in the Gira Project Assistant, the access data for a user must be set up.
- The Gira G1, the alarm control unit Connect and the commissioning PC (with Gira Project Assistant installed) must be located on the same network.

9.1

Initial commissioning

Once you have selected the “Gira X1 and security system” option in the Gira G1’s basic configuration, the initial commissioning configuration starts up, followed by a dialog that allows you to make the connection to the Alarm Connect security system.

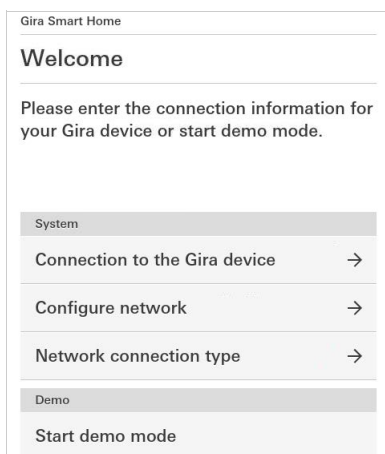

Figure 92
View [Settings]

- 1 If the Gira G1 is connected to the network via LAN and DHCP, you can proceed directly to step 2.
If the Gira G1 is connected to the network via WLAN and/or without DHCP, you must first connect to the network before you can connect to the security system.
- 2 Enter the access data (user name and password), which you created earlier in the GPA [see 9.1.2.1].
- 3 Enter the access data for the door communication system, if appropriate [see 15.2.1].
- 4 Select the locations for the weather station, as appropriate [see 17.1.1].



Note **Simultaneous use of the Gira X1 and security system**

If the Gira X1 and the Alarm Connect security system are used simultaneously in a project, please enter the IP address of the Gira X1 under connection data.

Alarm Connect security system settings

Settings for the security system can be made in the [Settings] view.

1 Open the [Settings] view by tapping the gear symbol in the navigation bar.

✓ This takes you to the [Settings] view with the following subcategories:

- System menu
- Additional functions
- Administrator functions*
- Door communication**
- Information

* Only if the user has administrator rights.

** only if the application was selected during commissioning.

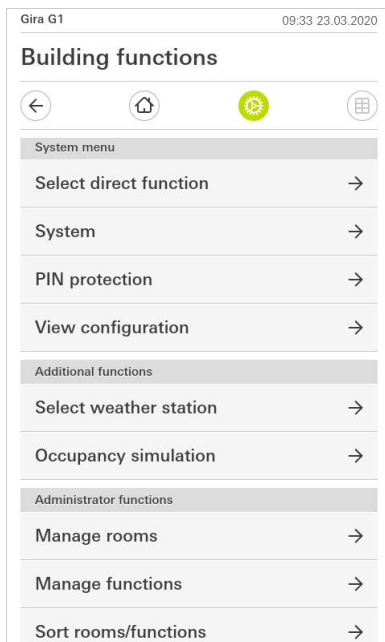

Figure 93
View [Settings]

Note Number of menu entries

The number of menu entries in the [Settings] view depends on the applications you want to run on the Gira G1.

The following examples always show the complete version. If, for example, you do not want to operate a Gira door communication system, the respective configuration options are not displayed.

10.1

System menu

The following functions are available in the system menu:

- Select direct function [see 9.1.1]
- System [see 9.1.2]
- PIN protection [see 9.1.3]
- View configuration [see 9.1.4]

10.1.1

Select direct function

The direct function is a function that can be operated from any view by placing the palm of the hand on the screen. The "Switching (button function)", "Button (On/Off)", "Button (Press/Release)" and "Scene auxiliary unit" functions can be configured as the direct function.

It is recommended to choose one of the main functions of the room in which the Gira G1 is positioned here, e.g switching the ceiling light.

- 1 Tap the [Select direct function] button in the system menu.
- ✓ The [Select direct function] page opens.

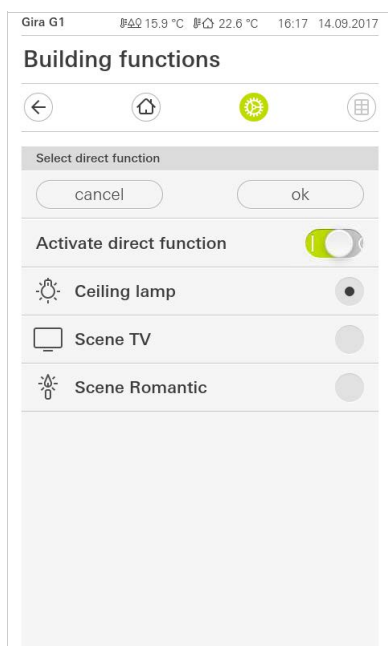

Figure 94
Select direct function

- 2 Activate the [Activate direct function] switch.
- ✓ A selection field appears behind the listed functions. The activated function is indicated by a dot in the selection field.
- 3 Activate the selection field behind the function that you have chosen as the direct function.
 - 4 Tap the [OK] button.
- ✓ The data is saved. The system menu opens.

10.1.2 System

- 1 Tap the [System] button in the system menu.
- ✓ The [System] page opens.

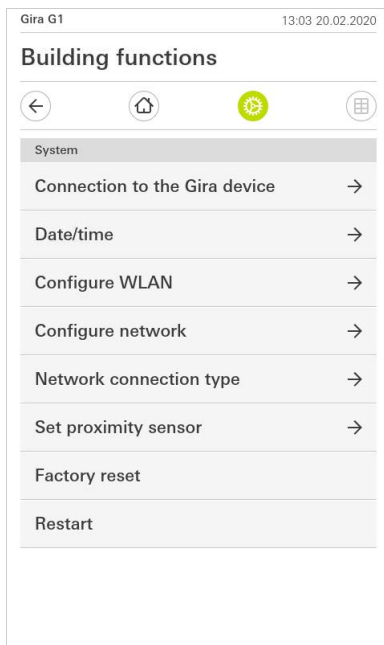

Figure 95
System settings

The following menu items are available:

- Connection to the Gira device [see 9.1.2.1]
- Change password [see 9.1.2.2]
- Date/time [see 9.1.2.3]
- Configure WLAN [see 9.1.2.4]
(only displayed if "WLAN" was selected as the network connection type)
- Configure network [see 9.1.2.5]
- Network connection type [see 9.1.2.6]
- Set proximity sensor [see 9.1.2.7]
- Factory reset
- Restart

10.1.2.1

Connection to the Gira device

Gira Smart Home

Welcome

Please enter the connection information for your Gira device and configure remote access, if appropriate.

Connection to the Gira device

cancel ok

IP address
192.168.137.189

User name
Lutz

Password
.....

Figure 96
Connection to the
Gira device

To connect the Gira G1 to the security system, proceed as follows:

- 1 Enter the IP address of the alarm control unit Connect.
 - 2 Enter the user name and password.
 - 3 Confirm your entries with OK.
- ✓ The data is saved. The connection to the security system is created.

10.1.2.2

Change password

Gira X1 14:52 03/11/2016

Building functions

← Home Settings Grid

Changing the password

cancel ok

Password (old)
...
Old password must be filled out.

Password (new)
...
New password must be filled out.

Repeat password
...
Repeat password must be filled out.

Figure 97
Change password

You can change the user password assigned during configuration. Proceed as follows:

- 1 Enter the old password.
 - 2 Enter a new password.
 - 3 Repeat the new password.
 - 4 Confirm your entries with OK.
- ✓ The new password is now saved.

10.1.2.3

Date/time

Here you can set the time and date format in the status bar.

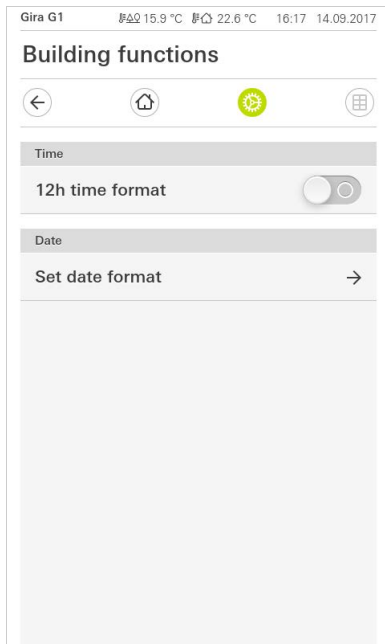

Figure 98
Time/date

- 1 Time: Select 12-hour or 24-hour format.
 - 2 Date: Set the desired date format and accept by tapping [OK].
- ✓ The selected formats are directly displayed in the status bar.

10.1.2.4 Configure WLAN

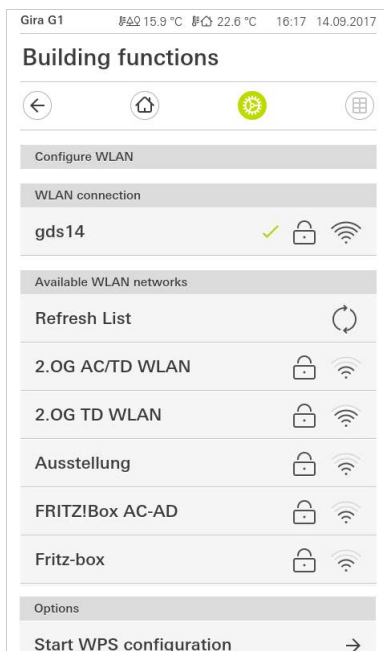

Figure 99
Configure WLAN

The WLAN connection is displayed here if the Gira G1 is already connected to a WLAN network.

WLAN connection

All WLAN networks in the vicinity of the Gira G1 are displayed under "Available WLAN networks". If you wish to connect the Gira G1 to one of the listed WLAN networks, proceed as follows:

Available WLAN networks

- 1 Tap the WLAN network with which you wish to connect the Gira G1.
 - 2 Enter the password for the WLAN network and confirm with [OK].
- ✓ The Gira G1 connects to the WLAN network.

WPS (Wi-Fi Protected Setup) is a function that enables you to set up WLAN connections at the push of a button without entering a password. The router must support WPS to use this function.

Options - Start WPS configuration

Connect the Gira G1 to the WLAN as follows via the WPS function:

- 1 On the Gira G1, tap [Start WPS configuration].
- ✓ This displays a view of all WLAN networks that support WPS.
- 2 Select the WLAN network to which you want to connect the Gira G1 and confirm by tapping [OK].
- 3 Activate the WPS function on your WLAN router within the next 2 minutes.
- ✓ The connection to the WLAN network is established automatically.

10.1.2.5 Configure network



Warning Failure of Gira G1

The network connection can fail when settings are changed on the [Configure network] page. This can lead to functional disturbances of the Gira G1. Only an electrician with network expertise is allowed to configure the network.

When configuring the network access of the Gira G1, you can choose between automatic (DHCP) and manual configuration of the network. DHCP is selected in the factory settings of the Gira G1. In this case, the network parameters are automatically specified by the router.

DHCP

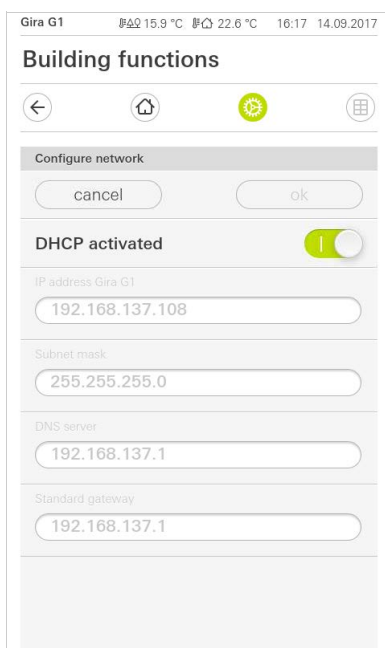

Figure 100
Configure network

To configure the network manually, proceed as follows:

- 1 Deactivate DHCP by moving the "DHCP activated" slider switch to Off.
- ✓ You can now edit the input fields for the network settings.
- 2 Enter the corresponding data for the network access.
- 3 Confirm your entries with [OK].
- ✓ The data is saved. The system menu opens.

10.1.2.6

Network connection type

Specify here if you want to connect the Gira G1 to the network via LAN or WLAN.

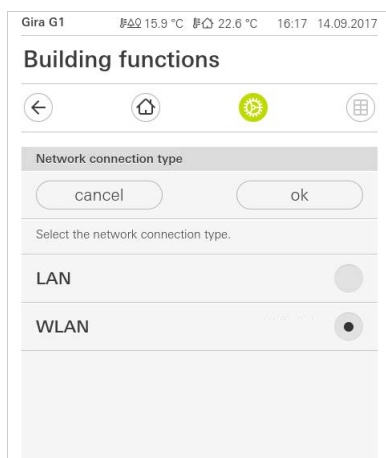

Figure 101
Network
connection type

- 1 Select the desired connection type (LAN or WLAN) and confirm with [OK].
- ✓ The Gira G1 restarts and the network connection type is set.

10.1.2.7

Set proximity sensor

Here you can set the distance at which the Gira G1 is activated from sleep mode when a hand approaches.

- 1 Tap the [Set proximity sensor] button.
- ✓ The [Set proximity sensor] page opens.

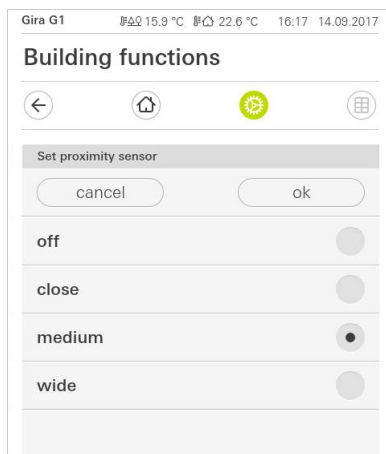

Figure 102
Set proximity sensor

- 2 Choose between the settings of the proximity sensor:
 - off (the proximity sensor is deactivated, i.e., the interface must be tapped to switch on the Gira G1),
 - close (the sensor reacts at a short distance),
 - medium (the sensor reacts at a medium distance),
 - wide (the sensor reacts at a long distance).
 - 3 Tap the [OK] button.
- ✓ The proximity sensor has been set. The system menu opens.

10.1.3

PIN protection

You can add PIN protection for the settings in the system menu. This protects the Gira G1 against unwanted changes. To activate PIN protection, proceed as follows:

- 1 Tap the [PIN protection] button.
- ✓ The [PIN protection] page opens.

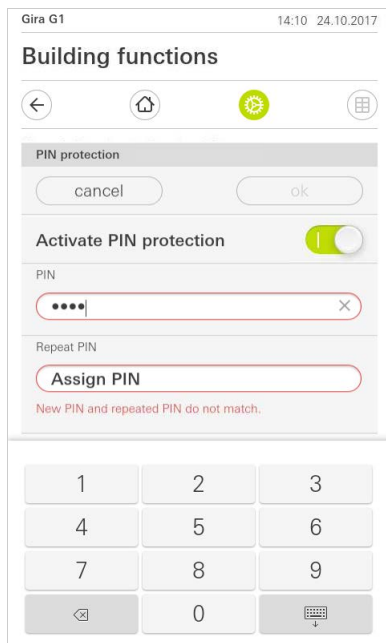

Figure 103
PIN protection

- 2 Slide the "Activate PIN protection" switch to the right.
 - 3 Enter a PIN in the upper box and repeat it in the second box.
 - 4 Confirm the entry with [OK].
- ✓ The system menu of the Gira G1 can now only be opened after the PIN is entered.

10.1.4

View configuration

In the view configuration, you define the functions displayed and the order of the functions for the action area.

- 1 Tap the [View configuration] button.
- ✓ The [View configuration] page opens.

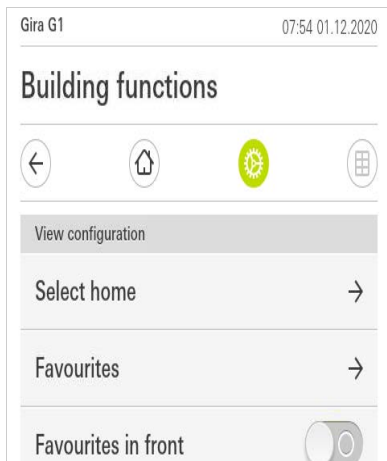

Figure 104
View configuration

- ✓ The following menu items are available:
- Select Home [see 9.1.4.1]
 - Favourites with sub-items
 - Define favourites [see 9.1.4.2]
 - Sort functions [see 9.1.4.3]
 - Restore defaults [see 9.1.4.4]
 - Favourites in front [see 10.1.4.5]

10.1.4.1

Select Home

Here you can define whether the Home view is displayed in tile or detail view when the Home button is tapped.

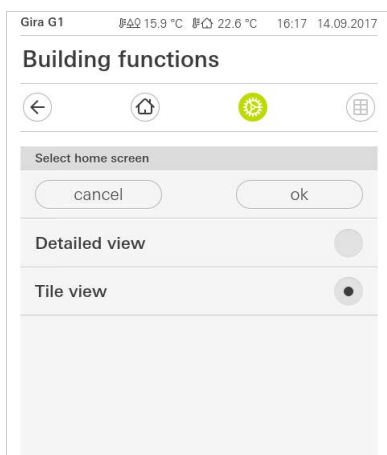

Figure 105
Select Home

- 1 Select the desired view for the Home view.
- 2 Tap the [OK] button.

10.1.4.2

Define favourites

You can select the functions to be displayed directly in the action area here.

- 1 Open the [View configuration] page.
- 2 Tap the [Favourites] button, then tap [Define favourites].
- ✓ The [Define favourites] page opens and displays all the existing function folders.

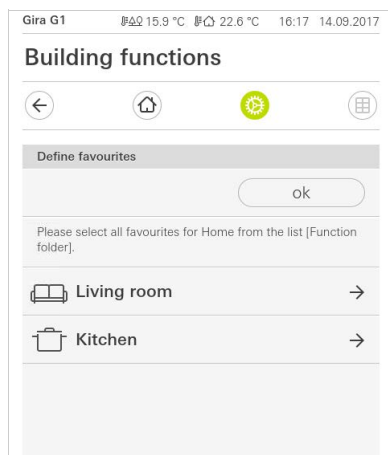

Figure 106
Define favourites

- 3 Switch to the function folder containing the function you want to display as a favourite.
- ✓ The [Define favourites, function folder] page opens.

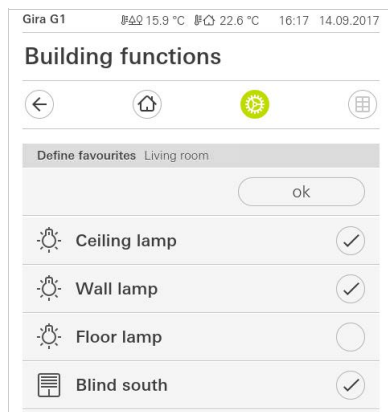

Figure 107
Select functions

- 4 Activate the functions that you wish to import as favourites.
- 5 Tap [OK].
- ✓ The [Define favourites] page opens with the list of function folders.
- 6 Define additional favourites in the same way.
- 7 When you are finished, tap [OK].
- ✓ The [View configuration] page opens.
- 8 Close and save your settings:
Tap [OK].
- ✓ A message informs you that changes have been made.
- 9 Confirm this by tapping [OK].
- ✓ The application on the Gira G1 restarts. The defined favourites then appear in the action area.

10.1.4.3

Sort functions

Here you can determine the order in which the functions and applications are displayed in the Home area of the Gira G1.

- 1 Open the [View configuration] page.
- 2 Tap the [Favourites] button, then tap [Sort functions].
- ✓ The [Sort functions] page opens and displays all the elements available on the Gira G1.

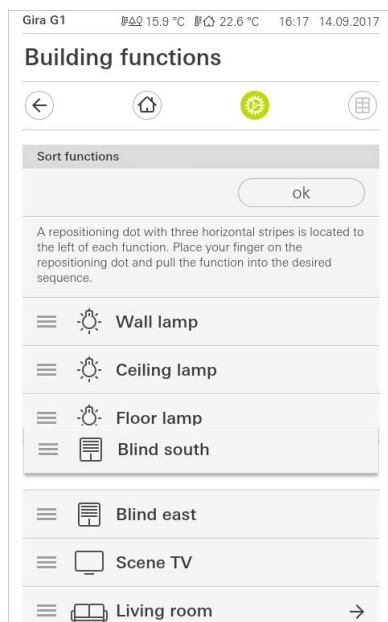

Figure 108
Sort functions

- 3 Place your finger on the shifting point of the desired entry and move the functions into the order you want.
- 4 Use the same method to move other entries.
- 5 When you are finished, tap [OK].
- ✓ The [Favourites] page opens.
- 6 Close and save your settings:
Tap [OK].
- ✓ A message informs you that changes have been made.
- 7 Confirm this by tapping [OK].
- ✓ The application on the Gira G1 restarts. The favourites then appear in the action area in the order defined by you.

10.1.4.4

Restore defaults

Here you can restore the action area view to the original state during configuration.

- 1 Open the [View configuration] page.
- 2 Tap the [Favourites] button, then tap [Restore defaults].
- ✓ A message appears asking whether you want to reset all settings to the original state at commissioning.
Confirm this by tapping [OK].
- ✓ The application on the Gira G1 restarts. The favourites appear in the action area in their original state at commissioning.

10.1.4.5 Favourites in front

This is where you can determine whether your favourites should be displayed on the home view.

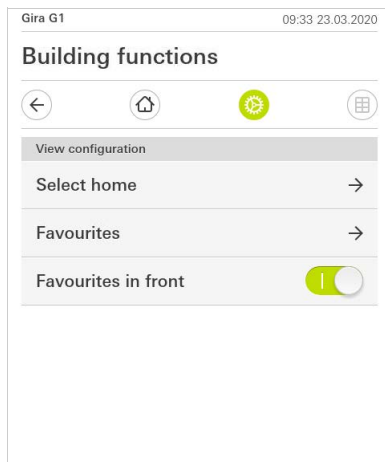

Figure 109
Favourites in front

- 1 Slide the slider switch to the right if the favourites functions should be displayed in front of other tiles, such as "Building", "Door communication" and "Weather forecast".
- ✓ Your favourites will be displayed first in the home view.

10.2 Additional functions

The following functions are available under Additional functions:

- Select weather station [see 20]
- Occupied-home simulation [see 7.10]

10.3

Administrator functions

10.3.1

Manage rooms

- 1 Tap on the [Manage rooms] button in the system menu.
- ✓ The [Manage rooms] page opens.
- 2 Tap on the room that you wish to manage.
- ✓ You now have the option to rename the selected room and change the room's symbol.

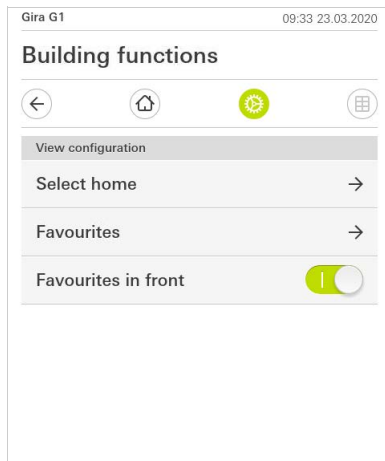

Figure 110
Manage rooms

10.3.2

Manage functions

- 1 Tap on the [Manage functions] button in the system menu.
- ✓ The [Manage functions] page is opened and you can select from the following options:
 - Create new function [see 10.3.2.1]
 - Manage function [see 10.3.2.2]

10.3.2.1

Create new function

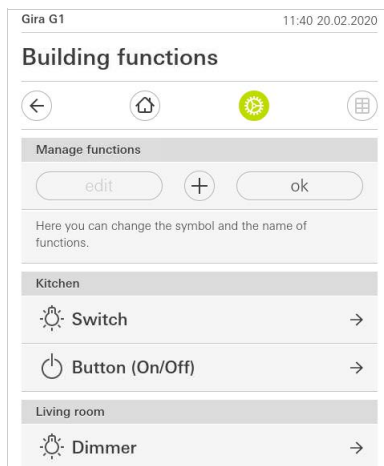

Figure 111
New Function
Create

- 1 Tap the [+] button.
- 2 Tap on the function that you wish to add.

10.3.2.2

Manage function

- 1 Tap on the function that you wish to manage.
- ✓ You now have the option to rename the selected function and change the function's symbol.

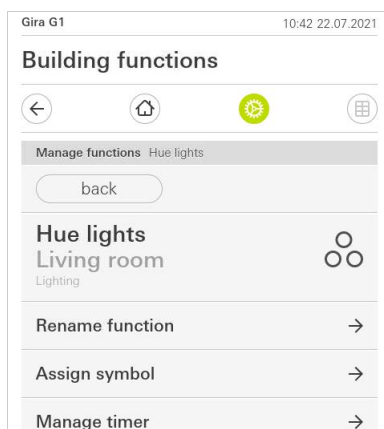

Figure 112
Manage function

10.3.3

Sort rooms/functions

- 1 Tap on the [Sort rooms/functions] button in the system menu.
- ✓ The [Sort functions] page opens.
- 2 Tap on the relevant function folder to sort functions within a folder.
- 3 Place your finger on the three horizontal lines in front of the function and drag them into the desired order.
- 4 Press to confirm your entry [Finish].

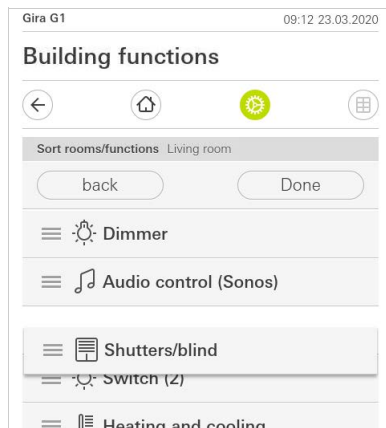

Figure 113
Sort rooms/functions

10.3.4

Manage subsections

- 1 Tap on the [Manage trades] button in the system menu.
- ✓ The [Manage trades] page opens.
- 2 Tap on the trade that you wish to manage.
- ✓ You now have the option to rename the selected trade and change the trade's symbol.

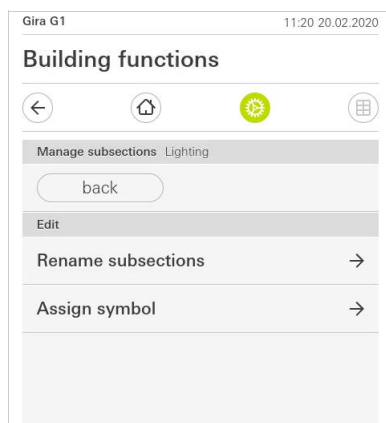

Figure 114
Managing trades

10.3.5

Manage users

You have the option to issue or withdraw authorisation for functions to or from individual users.

- 1 Tap on the [Manage users] button in the system menu.
 - 2 Tap on the users you wish to manage.
- ✓ The following menu items are available:
- Select [see 10.3.5.1].
 - Adding... [see 10.3.5.2].

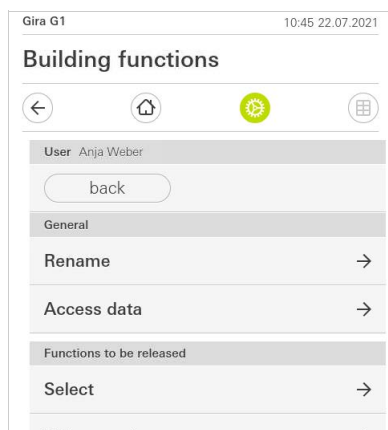

Figure 115
Manage users

10.3.5.1

Select functions

You have the option to select functions by buildings or trades.

- 1 Tap on the check mark after [Authorise everything].
- ✓ If the check mark is removed, all the functions for the building section or trade are blocked for the user concerned.
- 2 Tap on the horizontal arrow after the room or trade concerned to authorise or block individual functions.
- ✓ The number combination beneath the building or trade displays the number of available/authorised functions.

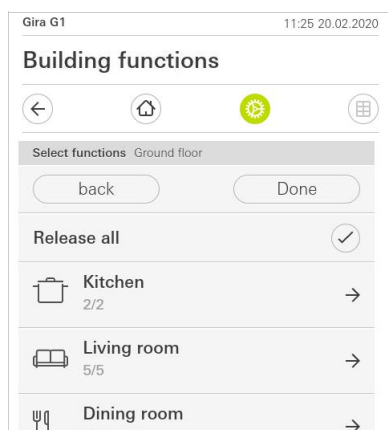

Figure 116
Select functions

10.3.5.2

Take over functions

You have the option to apply other users' authorisation settings.

- 1 Tap on the user whose authorisation settings that you wish to apply.
 - 2 Tap on [OK] in the confirmation dialogue.
- ✓ The selected user's authorisation settings are applied.

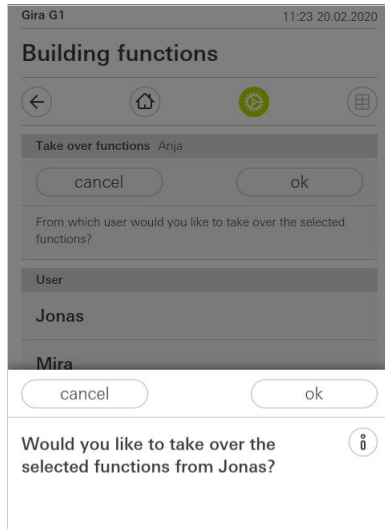

Figure 117
Take over functions

10.4

Information

The following functions are available in the Information area:

- License agreement
This is where the license agreements for the Gira G1 are displayed.
- Gira app version ...[see 6.2.1]

10.4.1

Gira app version

This area provides you with information on the installed and potentially available versions of the Gira Smart Home app:

- Installed version
Here you will see the currently installed version of the Gira Smart Home app installed on the Gira G1.
- Available versions
If an update is available for the Gira Smart Home app, it will be displayed here. To install the app update, simply tap the new version.

11

Operating the Alarm Connect security system

11.1

Status bar

Gira G1



Figure 118

Gira G1 status bar

The symbols in the status bar have the following meanings:

- [1] [Ring tone off] appears if the ring tone has been switched off in the "Door communication" application.
- [2] [Automatic door opener] appears when automatic door opening has been activated.*
- [3] The warning symbol in the status bar shows that the Gira G1 is no longer functioning.
If you tap the warning symbol, the relevant error message is displayed.
- [4] Time and date display.

*only displayed when using the Gira door communication system.

11.2

Navigation bar

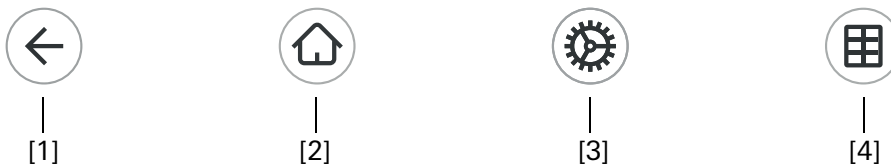

Figure 119

Gira G1
navigation bar

The buttons in the navigation bar have the following functions:

- [1] [Back] opens the previously opened page.
- [2] [Home] opens the home page of the action area.
- [3] [System] opens the [Settings] view.
- [4] [Change view] switches between tile and detail view.

11.3

Alarm-specific buttons and displays

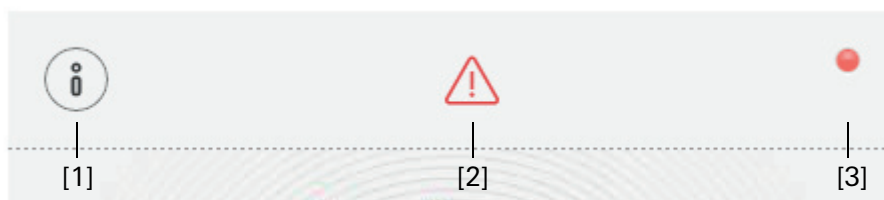

Figure 120

Alarm-specific but-
tons

- [1] [Information] opens the list of present messages.
- [2] [Warning] shows that there are messages.
- [3] [Status] indicates that the security area is not ready for activation.

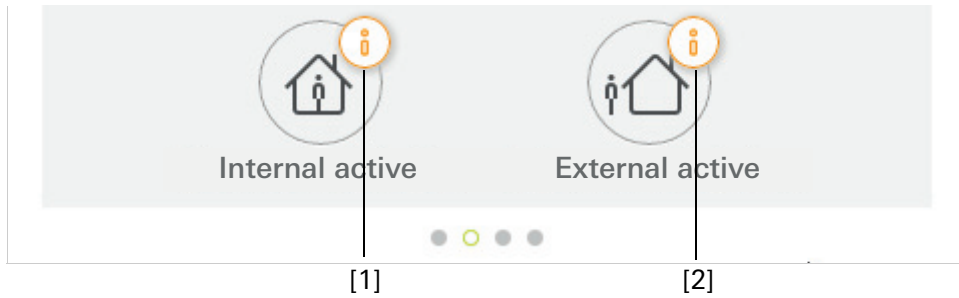

Figure 121
Alarm-specific displays

- [1] Internal activation not possible
- [2] External activation not possible

11.4

Externally activating a security area

To externally activate a security area via the Gira G1, proceed as follows:

- 1 Tap the operation unit tile of the security area that you would like to externally activate.
 - ✓ The security area view opens and shows the activation status.
- 2 Tap the [Externally activate] button.
- 3 Enter your user PIN in the window that opens.
 - ✓ The exit delay begins and will be shown on the Gira G1.
The wireless operating unit simultaneously indicates that the exit delay is running.
- 4 Exit the security area and lock the door, if appropriate.
 - ✓ The security area will be externally activated at the end of the exit delay as long as no events have meanwhile occurred to prevent activation.

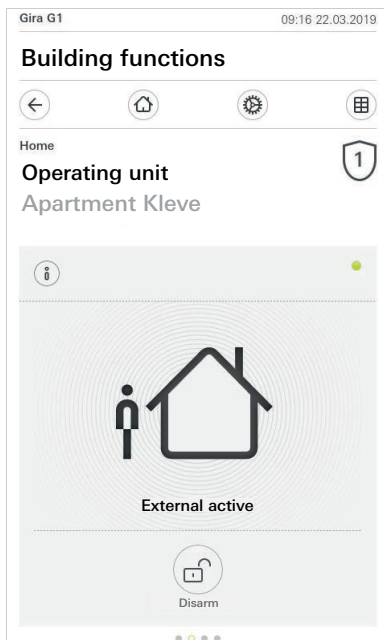

Figure 122
Externally activated state

11.5

Internally activating a security area

To internally activate a security area via the Gira G1, proceed as follows:

- 1 Tap the operation unit tile of the security area that you would like to internally activate.
✓ The security area view opens and shows the activation status.
- 2 Tap the [Internally activate] button.
- 3 Enter your user PIN in the window that opens.
✓ The security area is internally activated.

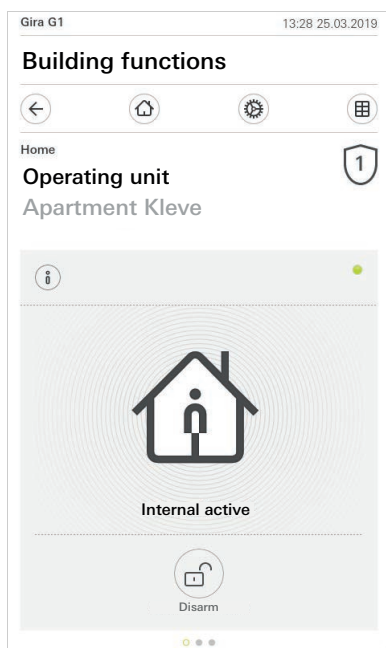

Figure 123
Internally activated
state

11.6

Deactivating a security area

To deactivate a security area via the Gira G1, proceed as follows:

- 1 Tap the [Deactivate] button in the security area view.
- 2 Enter your user PIN in the window that opens.
✓ The security area is deactivated.

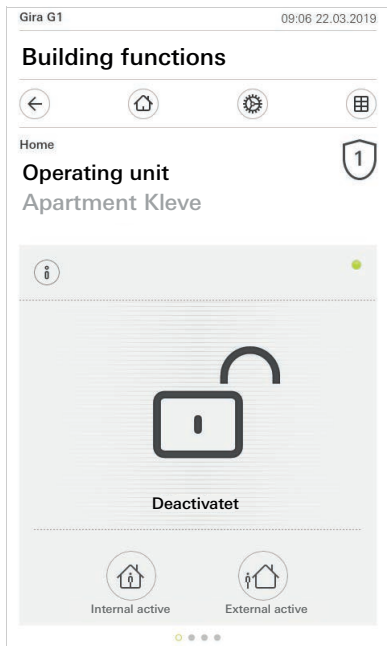

Figure 124
Deactivated state

11.7 Viewing and acknowledging alarms and messages

To acknowledge alarms and messages present in the security area, please proceed as follows:

- 1 Tap the [Information] button in the security area view.
- ✓ A list will open up, containing the present alarms and messages.
- 2 Tap the [Confirm] button.
- 3 Enter your user PIN in the window that opens.
- ✓ If the right PIN has been entered, the message will be removed from the list.

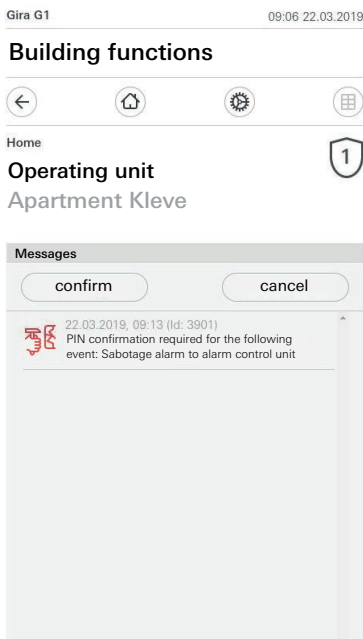

Figure 125
Alarms and messages

Configuring the Gira HomeServer Client/eNet Client

12.1

Initial commissioning

Once you have selected the “Gira HomeServer/eNet Server” option in the basic configuration of the Gira G1 and tapped [Start], the Gira G1 launches the initial commissioning configuration, then displays a start page in which you can implement the settings. The start page initially only contains the “Settings” button.



Figure 126
Start page

Proceed as follows with the commissioning:

- 1 Tap "Settings".
- 2 Check the network connection and re-establish it again if necessary [see 11.4].
- 3 Tap “Gira app settings”. In the “App settings” view, you can select the applications that you want to run on the Gira G1.
- 4 Tap the desired app.
- 5 Slide the “Activate app” switch to the right.
- 6 Slide the “Select as main application” switch to the right, if applicable (see below).
- 7 Now tap the back button to quit the settings and return to the start page.

✓ The start page will now also show the apps that you activated in the settings.

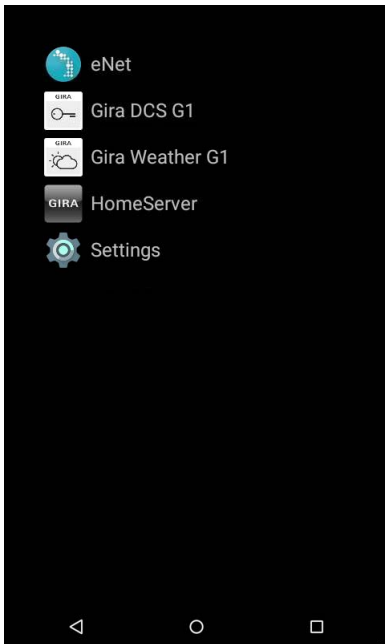

Figure 127
Start page



- 8 Now tap the desired app and commission it:
 Configuring the HomeServer Client [see 12].
 Configuring the eNet Client [see 14].
 Configuring the door communication system [see 15].
 Configuring the weather forecast [see 17].

If you activate the “Select as main application” setting for an app, the Gira G1 displays this app when you reactivate it from idle state. You can only use this option for one app. If this option is not activated, the Gira G1 always launches with the last app to be open.

Select as main application

12.2 Navigation bar

The navigation bar is located in the lower part of the screen. The three buttons have the following functions:

-  The back button takes you back a step every time it is tapped.
-  The Home button opens the start screen.
-  The Task button displays all active apps. You can close the apps by swiping sideways.

Note Showing the navigation bar

The navigation bar is hidden in the “Door communication” and “Weather” applications. You can show the navigation bar again by swiping upwards from the bottom edge of the screen.

12.3 Settings



Open the "Settings" view by tapping the gear symbol on the start screen.

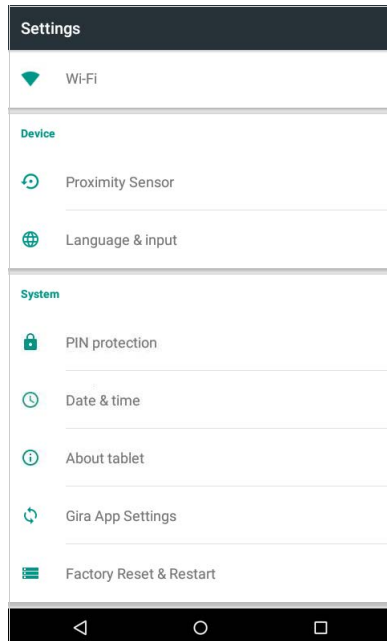

Figure 128
Settings

The following items are available in the settings menu:

- Wireless & Networks [see 11.4]
You configure the network connection here.
- Device [see 11.5]
You set the sensitivity of the proximity sensor and select the language here.
- System [see 11.6]
Here you can, among other things, select the applications to be run on the Gira G1. You can also view technical information and license texts here.

12.4 Wireless & Networks

You can connect the Gira G1 to the network either per LAN or WLAN.



Warning **Failure of Gira G1**

The network connection can fail when network settings are changed. This can lead to functional disturbances of the Gira G1.
Only an electrician with network expertise is allowed to configure the network.

12.4.1

Configure LAN network

Note
Deactivate WLAN

The WLAN function must be switched off if you wish to connect the Gira G1 to the network via LAN.

When configuring the network access of the Gira G1, you can choose between automatic (DHCP) and manual configuration of the network. DHCP is selected in the factory settings of the Gira G1. In this case, the network parameters are automatically specified by the router.

DHCP

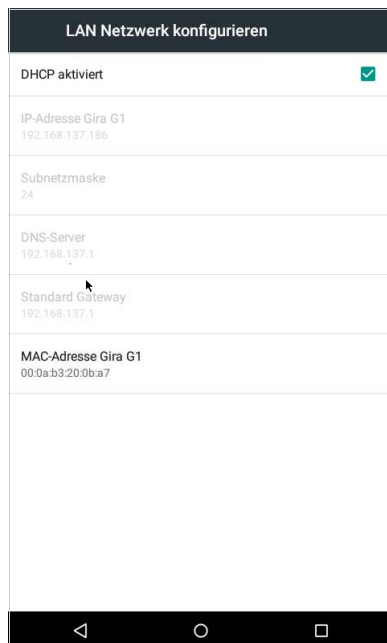

Figure 129
 Configure LAN network

To configure the network settings of the LAN connection manually, proceed as follows:

Manual network settings

- 1 Switch off the "DHCP" function by deactivating the "DHCP activated" selection box.
- ✓ You can now edit the input fields for the network settings.
- 2 Enter the corresponding data for the network access.
- 3 Confirm each of your entries with [OK].
- ✓ The data is saved. The settings menu opens.

12.4.2 Configure WLAN

Note
No WLAN with PoE connection module

If the Gira G1 is run with a PoE connection module, operation via a WLAN connection is not possible.

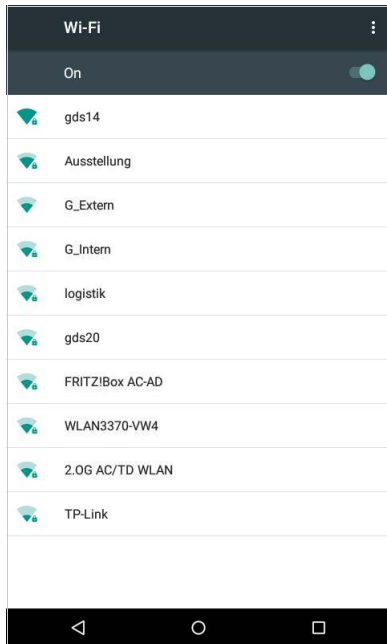

Figure 130
Configure WLAN

If you have activated the WLAN function using the slider switch, all WLAN networks located in the Gira G1 environment are displayed in the "WLAN" view.

Available WLAN networks

If you wish to connect the Gira G1 to one of the listed WLAN networks, proceed as follows:

Establish WLAN connection

- 1 Tap the WLAN network with which you wish to connect the Gira G1.
 - 2 Enter the password for the WLAN network and confirm with [Connect].
- ✓ The Gira G1 connects to the WLAN network.

12.4.2.1

Establish WLAN connection via WPS

WPS (Wi-Fi Protected Setup) is a function that enables you to set up WLAN connections at the push of a button without entering a password.

Connection via WPS



Note
Router without WPS

If your router does not support WPS (Wi-Fi Protected Setup), you can only set up your wireless network manually.

If your router supports the "WPS Push Button" function, you can establish the WLAN connection as follows:

WPS Push Button

- 1 Press the WPS button on your router.
- 2 Tap the menu symbol  in the top right corner of the Gira G1 within the next 2 minutes and tap the entry [Advanced] in the menu that opens.
- 3 Tap the entry [WPS Push Button] in the menu which opens.
- ✓ The connection to the WLAN network is established automatically.

Connect the Gira G1 to the WLAN as follows via the "WPS with PIN entry" function:

WPS with PIN entry

- 1 Tap the menu symbol  in the top right corner of the Gira G1 and tap the entry [Advanced] in the menu that opens.
- 2 Tap the entry [WPS PIN entry] in the menu which opens.
- 3 Within the next 2 minutes, enter the PIN displayed in your WLAN router.
- ✓ The connection to the WLAN network is established automatically.

To configure the network settings of the WLAN connection manually, proceed as follows:

Manual network settings

- 1 Tap the desired WLAN connection until a dialog opens.
- 2 Tap "Connect to network" in the new dialog.
- 3 Activate the "Advanced options" function in the window that opens.
- 4 Tap "DHCP" and choose the "Static" setting in the dialog that opens.
- ✓ You can now edit the input fields for the network settings.
- 5 Enter the corresponding data for the network access.
- 6 Tap [Connect] to adopt the changes and establish the connection to the WLAN.

12.4.3

Advanced WLAN settings

To open the menu of advanced WLAN settings, please tap the menu symbol  in the top right corner of the Gira G1 within the WLAN settings.

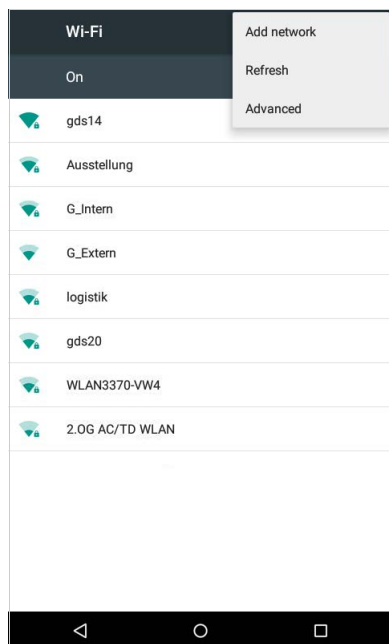

Figure 131
Advanced WLAN
settings

A menu opens, containing the following entries:

- Add network
This menu item allows you to add a WLAN manually.
- Update
Updates the list of available WLANs.
- Advanced
Opens a menu containing two entries:
 - WPS Push Button
This function allows you to establish a connection to the WLAN router by means of WPS (see Seite 95).
 - WPS PIN entry
This function allows you to establish a connection to the WLAN router by means of WPS (see Seite 95).

12.5 Device

12.5.1 Set proximity sensor

Here you can set the distance at which the Gira G1 is activated from sleep mode when a hand approaches.

- 1 Tap [Proximity sensor], then [Set proximity sensor].
- ✓ The [Set proximity sensor] page opens.

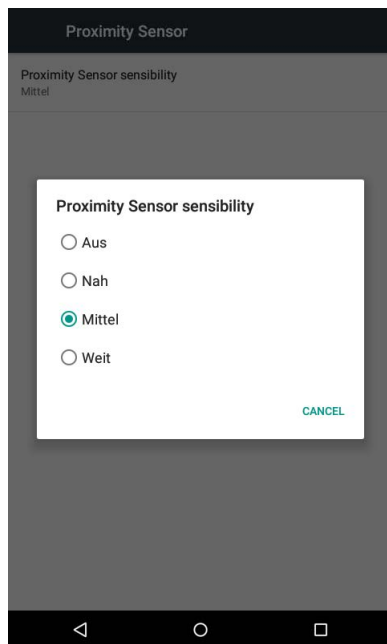

Figure 132
Set proximity sensor

- 2 Choose between the settings of the proximity sensor:
 - off (the proximity sensor is deactivated, i.e., the interface must be tapped to switch on the Gira G1),
 - close (the sensor reacts at a short distance),
 - medium (the sensor reacts at a medium distance),
 - wide (the sensor reacts at a long distance).
- ✓ The proximity sensor has been set.

12.5.2 Language & Input

Here you determine the language with which the applications should be run on the Gira G1.

- 1 Tap [Language].
- ✓ The selection of the available languages is displayed.
- 2 Tap the desired language.
- ✓ The language is changed.
- If you subsequently start an app on the G1, the interface is displayed in the required language.
- Please note: This setting has no influence on the designations of the functions that you have configured in the HomeServer or eNet server.

12.6 System

PIN protection

You can add PIN protection for the settings in the settings menu. This protects the Gira G1 against unwanted changes. To activate PIN protection, proceed as follows:

- 1 Tap the [PIN protection] button.
- ✓ The [PIN protection] page opens.

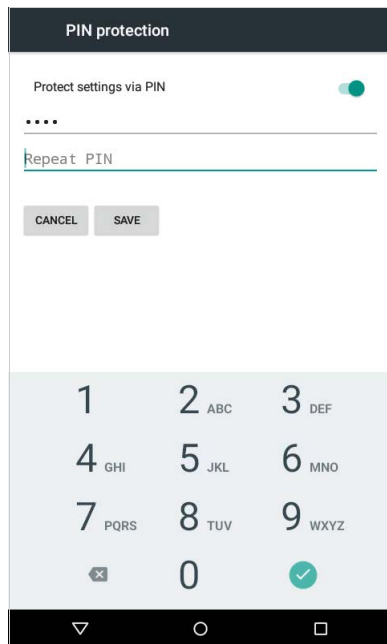

Figure 133
PIN protection

- 2 Slide the "Activate PIN protection" switch to the right.
- 3 Enter a PIN in the upper box and repeat it in the second box.
- 4 Confirm the entry with [OK].
- ✓ The settings menu of the Gira G1 can now only be opened after the PIN is entered.



Note on PIN protection

In order for the PIN protection to be active, you must close the settings menu via the Task list, both after the initial input and after each further use (following activation via the PIN).

To do so, tap the square in the footer and slide the window with the settings menu to the side.

12.6.1 Date & Time

Here you can set the time zone.

12.6.2 Information

Version information on the software installed and licences used is displayed here.

12.6.3 Gira app settings

In the “App settings” view, you can select the applications that you want to run on the Gira G1. To select an app, please proceed as follows:

- 1 In the “App settings” view, tap the application that you want to run on the Gira G1.
- 2 Slide the “Activate app” switch to the right.
- 3 Slide the “Select as main application” switch to the right, if applicable (see below).
- 4 Now tap the back button to quit the settings and return to the start page.
- ✓ You will now see the app that you just activated on the start page.
- 5 Then tap the desired app and commission it:
 - Configuring the HomeServer Client [see 12].
 - Configuring the eNet Client [see 14].
 - Configuring the door communication system [see 15].
 - Configuring the weather forecast [see 17].

If you activate the “Select as main application” setting for an app, the Gira G1 displays this app when you reactivate it from idle state. You can only use this option for one app. If this option is not activated, the Gira G1 always launches with the last app to be open.

Select as main application

If an update is available for the app, the new version will be offered as an update here. Tap the entry to begin updating the app.

Available versions

If the app has already been updated to a newer version, you can reset the app to an earlier version here. You will see the following options when you tap on the entry:

Other versions

- Use most recently installed version
The most recently installed version is displayed here. Tap this entry if you wish to use this version of the app.
- Use delivery version
The version of the app originally installed on the Gira G1 at a firmware update is displayed here. Tap this entry if you wish to use this version of the app.

12.6.4 Factory reset & restart

Here you can use the corresponding button to perform a factory reset or restart of the Gira G1.

Configuring the Gira HomeServer app

The following prerequisites must be fulfilled for commissioning to be successful:

- The Gira HomeServer must be configured to be functional.
- A user is configured for the Gira G1 in the QuadConfig of the HomeServer expert. Please select the design "0" in the QuadConfig for the Gira G1.
- The Gira G1 and the Gira HomeServer are within the same network.
- The "Gira HomeServer/eNet Client" option has been selected in the Gira G1's basic configuration.
- The "HomeServer" app has been activated in the app settings.

13.1

Initial commissioning of the HomeServer app



Start the HomeServer app by tapping the icon with the Gira symbol on the start screen.

The "Profiles" view appears when you start the HomeServer app for the first time.

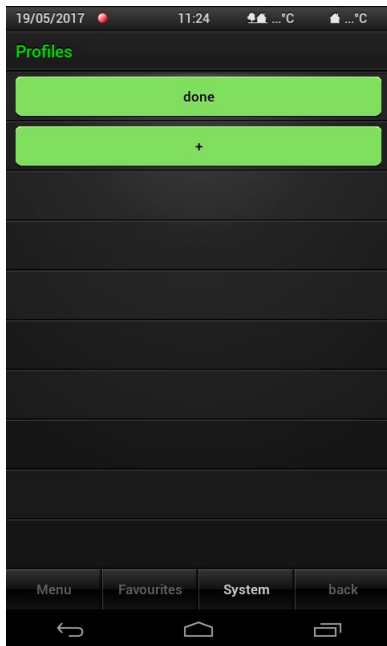

Figure 134
Create profile

Enter the connection settings for your Gira HomeServer in a profile. For this, please proceed as follows:

- 1 Tap the [+] button to open the input mask for a new profile.
- 2 Now enter the following information:

Connection to Gira HomeServer

-
- **Profile name:**
Freely choose a name for the profile, then enter it. This name may not be identical with the name specified in the HomeServer expert.
 - **Addresses:**
The IP addresses or URLs of the HomeServer are entered here. If you have received an address in the form of XYZ123.giradns.com from the Gira device portal, you can also enter this in the address field.
 - **Access data:**
Enter here the user name and password for the connection to the Gira HomeServer.
- 3 After entering all the data, tap [Save].
 - ✓ The newly created profile appears in the view above the [Edit] button.
 - 4 Tap the profile you have just created.
 - ✓ The app connects with the Gira HomeServer and displays the menu view.

For further information on the profile settings [see 13.3.1].

Operating the Gira HomeServer app



Start the Gira HomeServer app by tapping the icon with the Gira symbol on the start screen.

The Gira HomeServer app is divided into three areas, which can be opened by tapping on the corresponding tab:

- Menu [see 13.1]
- Favourites [see 13.2]
- System [see 13.3]

14.1

Menu

The "Menu" view displays all configured building functions.

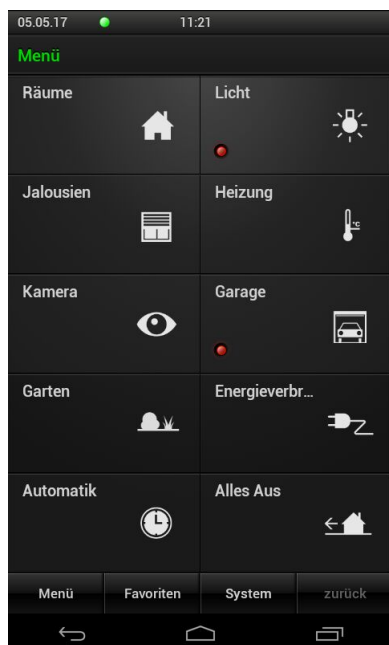

Figure 135
Menu view

The tile elements of the main menu can represent various functions. Navigation within the app is the main function of these tiles. Users can access the corresponding functional area or execute a function by tapping on a tile.

Specify in the HomeServer expert, the type and scope of elements and functions displayed in this view.

14.2 Favourites

The favourites make frequently used functions even more easily accessible in a view.

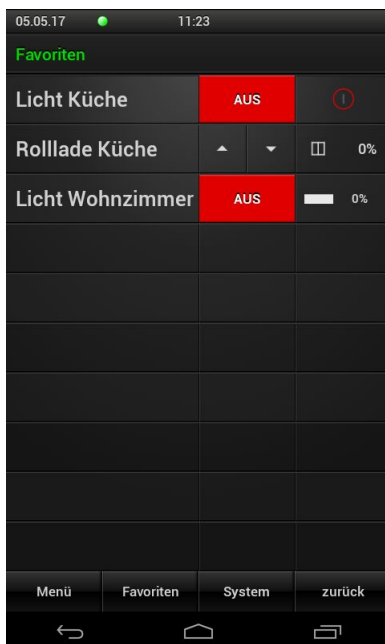

Figure 136
Favourites view

You can easily create your own list of favourites.
Before adding functions to the favourites list, or editing the existing favourites list, first activate favourites configuration mode [see 13.3.3].

14.3 System

Settings for the HomeServer app can be made in the "System" view. Please note that several settings on the Gira G1 have no function.

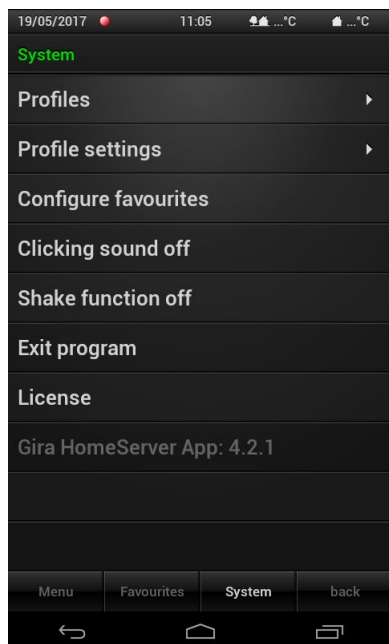

Figure 137
System

The following settings are available:

- Profiles [see 13.3.1]
- Profile settings [see 13.3.2]
- Configure favourites [see 13.3.3]
- Clicking sound on/off
No function on the Gira G1.
- Shake function on/off
No function on the Gira G1.
- Exit program
Exits the HomeServer app.
- License
Displays the license texts of the HomeServer app.

14.3.1 Profiles

The profiles are created, selected, and edited in this view.

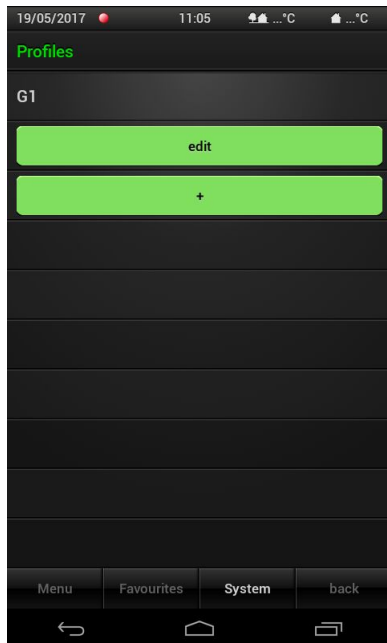

Figure 138
Profiles

Create a new profile:

Create profile

- 1 Tap the [+] button to open the input mask for a new profile.
- 2 Now enter the following information:
 - Profile name:
Freely choose a name for the profile, then enter it. This name may not be identical with the name specified in the HomeServer expert.
 - Addresses:
The IP addresses or URLs of the HomeServer are entered here. If you have received an address in the form of XYZ123.giradns.com from the Gira device portal, you can also enter this in the address field.
 - Access data:
Enter here the user name and password for the connection to the HomeServer.
- 3 After entering all the data, tap [Save].

Edit a profile:

Edit profile

- 1 Tap [Edit].
- 2 Select the profile which you wish to edit.
- 3 Make the changes and then tap [Save].

Delete a profile:

Delete profile

- 1 Tap [Edit].
- 2 Tap the cross symbol next to the profile that you wish to delete.
- ✓ The profile is deleted immediately!
- 3 Tap [Finished].

14.3.2 Profile settings

You can determine here the behaviour of the HomeServer app when starting.

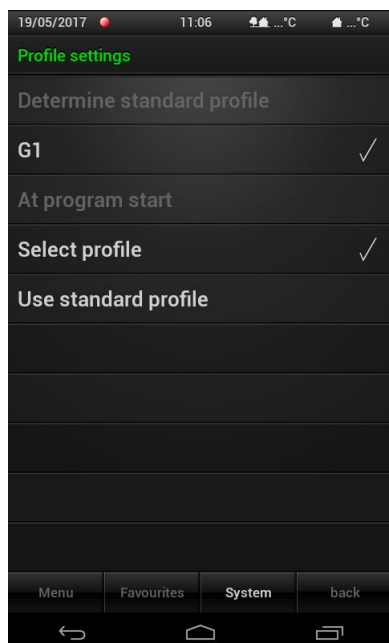

Figure 139
Profile settings

You can choose here between the following functions:

- **Select profile**
If you select this option, the HomeServer app displays the "Profiles" view after starting, and you can select the profile that should be displayed.
- **Use standard profile**
If you use this option, you can determine a standard profile which the app should display when the program is started. The next time the program is started, the profile selection is no longer displayed, rather the selected profile is automatically loaded and a connection to the HomeServer established.

14.3.3 Configure favourites

You can store the functions most frequently used in the favourites list. Using the function "Configure favourites", you can edit or transfer functions from the menu to the favourites list.

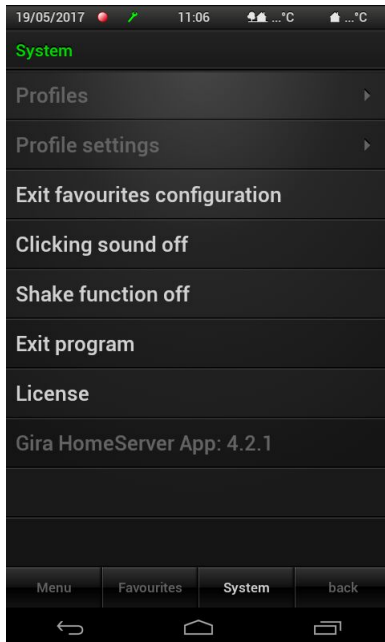

Figure 140
Configure favourites

If you wish to add functions to the favourites list, please proceed as follows:

Add functions

- 1 Tap [Configure favourites].
- ✓ Favourites configuration mode is active (recognizable by green tool symbol in the title bar).
- 2 Select the functions which should be added to the favourites:
For this, tap [Menu], select a desired function, and give it the name with which it should be displayed in the favourites overview.
- 3 Confirm with [OK] to add the function to the favourites list.
- 4 After selecting all the functions you require, exit Favourites mode in the system menu with [Exit favourites configuration].
- ✓ Your favourites can now be accessed via the [Favourites] menu item on the lower edge of the screen.

If you wish to edit the favourites list, please proceed as follows:

Edit favourites

- 1 Tap [Configure favourites].
- ✓ Favourites configuration mode is active (recognizable by green tool symbol in the title bar).
- 2 Tap [Favourites] to open the list of favourites.
- 3 Tap the function in the list which you wish to change.
- 4 A dialog opens where you can select the action which you wish to perform for this function.
- 5 Repeat the last two work steps until you have performed all the changes in the favourites list.
- 6 After performing all the changes, exit Favourites mode in the system menu with [Exit favourites configuration].

Configuring the eNet Client

The following prerequisites must be fulfilled for commissioning to be successful:

- The Gira eNet server must be configured to be functional.
- The Gira G1 and the Gira eNet server are within the same network.
- The "HomeServer / eNetClient" option has been selected in the Gira G1's basic configuration.
- The "eNetClient" app has been activated in the app settings.

15.1

Initial commissioning of the eNet SMART HOME app



Start the eNet SMART HOME app by tapping the eNet icon on the start screen.

If you are starting the eNet SMART HOME app for the first time, you are prompted to connect to the eNet server.

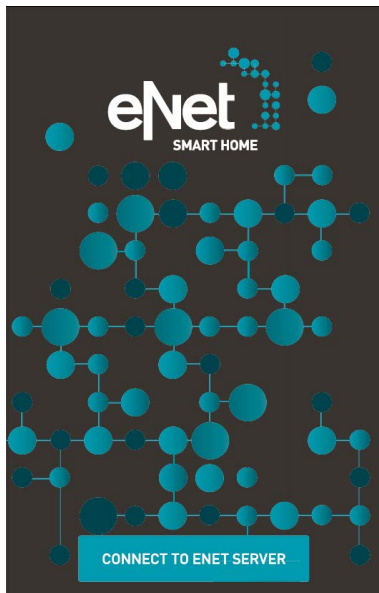

Figure 141
eNet SMART HOME
app start screen

To connect to the eNet server, proceed as follows:

- 1 Tap the [CONNECT TO ENET SERVER] button.
 - ✓ The app connects to the eNet server and prompts you to enter your user data.
- 2 Enter the user data given to you by your service partner or type "user" in both the default user name and password fields.
- 3 Then tap [LOG IN TO THE ENET SERVER].
 - ✓ The app connects to the eNet server and displays the "MY HOME" view.

You can find more detailed information on the configuration and operation of the eNet SMART HOME app in the Quick Start Guide for Android, which is available online at www.download.gira.de.

Quick Start Guide

Configuring door communication

When combined with the Gira DCS-IP gateway and a video door station, the Gira G1 can be used as a home station. The camera image of the door station automatically appears in the display of the Gira G1 when the doorbell rings. Communication can be initiated, the door can be opened or the light can be switched on at the touch of a finger.

16.1 Connecting the Gira G1 to the door communication system

The Gira G1 is connected to the door communication system via the DCS-IP gateway. For this, the Gira G1 is connected to the door communication system as a DCS communicator.

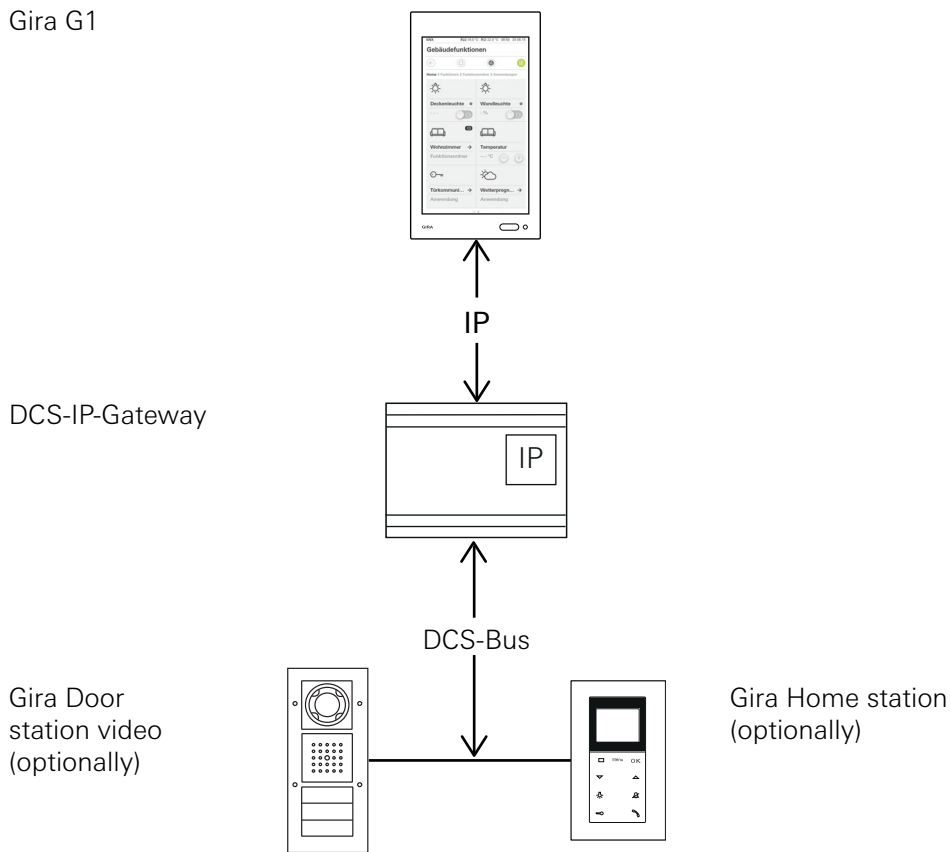

Figure 142
Gira G1 with DCS-IP gateway.

Note
Deactivate DHCP on the DCS-IP gateway

To ensure secure communication with the DCS-IP gateway it is recommended to deactivate DHCP in the network settings of the DCS-IP gateway and to manually assign the network settings.

16.2 Connecting to the DCS-IP gateway

Note
Requirements

For setting up the door communication function on the Gira G1, a functioning Gira door communication system, a DCS-IP gateway and a computer with network access must be available.

Prior to the set-up described below, a DCS communicator for the Gira G1 must be set up in the DCS-IP gateway (see documentation for DCS-IP gateway at www.download.gira.de ↗).

For set-up on the Gira G1, the access data for the DCS-IP gateway must be entered. Open the system menu and enter the access data for the Gira door communication system.

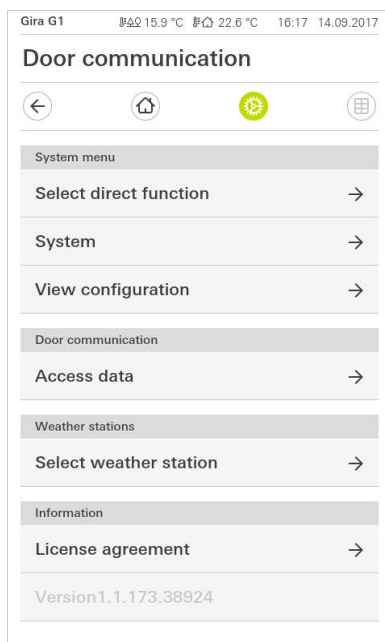

Figure 143
Door communication system menu.

16.2.1

Access data

The access data for the door communication system is entered in this view. For this, a DCS communicator for the Gira G1 must first be set up using the TCS-IP gateway assistant. The user name and password data specified there are entered into the respective fields.

Important Door communication failure

Changing the settings may lead to a failure of the door communication function on the Gira G1.

- 1 Open the system area.
 - 2 Tap the [Access data] button.
- ✓ The [Access data] page opens.

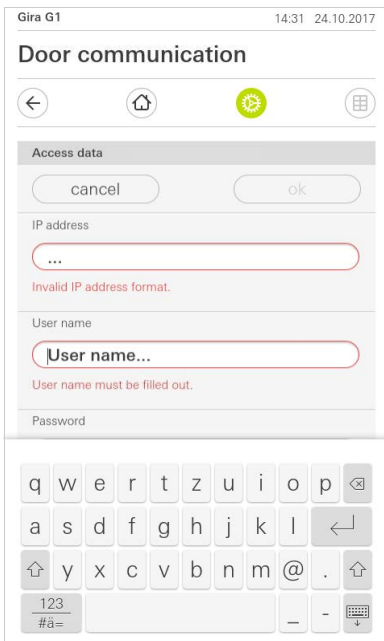

Figure 144
Access data
Door communication.

- 3 Enter the IP address of the DCS-IP gateway.
 - 4 Enter the user name and the password for the DCS communicator.
The user name and password must have been previously created in the DCS-IP gateway assistant.
 - 5 Tap the [OK] button.
- ✓ The access data for the door communication system are saved and the Gira G1 is reconfigured.
- ✓ The door communication user interface opens.

Operating door communication

17.1

Structure of the user interface

- 1 In detail or tile view, tap the door communication application.
- ✓ The door communication user interface opens.

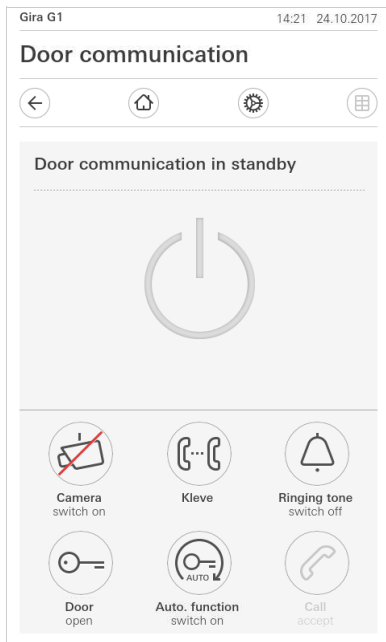

Figure 145
Door communication user interface.

The buttons have the following functions:

- Camera
Switches the camera image of the door station on and off.
If several cameras are present, you can scroll through the camera images by swiping horizontally.
- Ring tone
Switches the ring tone on or off.
The button is crossed out when the ring tone is switched off.
- Open door
Opens the door.
- Door call
Accepts an incoming call.
More details [see 16.2].

Note
Freely configurable buttons

During configuration, various functions can be assigned to the two central buttons of the user interface. ("Switch lights" and "Activate automatic mode" in this example).

During configuration, the following functions can be assigned to the two central buttons of the user interface:

Freely configurable buttons

- Lighting
Switches an optional DCS switching actuator.
 - Automatic door opener
Activates/deactivates the automatic door opener.
An active automatic door opener is indicated in the status bar.
 - Execute switching action
Triggers a switching action via a DCS switching actuator.
 - Call DCS communicator
Triggers a call to a different DCS communicator (e.g. on an additional Gira G1).
 - Call door station
Triggers a call to a door station.
 - Activate/deactivate forwarding
Activates/deactivates door call forwarding on a mobile phone.
-

17.2

Operating calls

17.2.1

Accepting a call

In the case of an incoming call the [Door call] button lights up green for two minutes.

- 1 Tap the [Door call] button to accept the call.
- ✓ The call has been accepted. The [Door call] button lights up during intercom communication.
-



Please note:
Call duration = two minutes

The maximum call duration is two minutes. The call is automatically terminated after this time.

If the call originates from a video door station, the display module automatically displays the camera image.

If the call originates from an audio door station, "Door call" and "Accept call" are shown on the display. In this case the call can also be accepted with the [Door call] button.

17.2.2

Ending a call

The [Door call] button lights up red during intercom communication.

- 1 Tap the [Door call] button to end the call.
- ✓ The call has been ended. The [Door call] button lights up green.
The call can be resumed again within 30 seconds.

17.2.3

Resuming a call

You can resume a call up to 30 seconds after ending the call. The [Door call] button lights up green during this time.

- 1 Tap the [Door call] button.
- ✓ The call has been resumed.
-

17.3

Switching the ring tone off

 **Important**
Switch the ring tone off only when needed

Switch off the ring tone only in exceptional cases. Otherwise there is a risk of not being able to hear the ring tone, e.g. in emergencies.

- 1 You can switch the ring tone on and off with the [Ring tone] button.
- ✓ The button is crossed out when the ring tone is switched off.
-

17.4

Opening the door

1. Tap the [Door opener] button.
- ✓ The door opener is activated.
In the case of several doors, the door opener for the door station from which the door call originated is activated within two minutes. Two minutes after the call has been received or 30 seconds after the door call was ended, the system switches back to the main door.
-

17.5

Switching the camera on

- 1 Tap the [Camera] button.
- ✓ The camera image is displayed.
In case of several cameras, the camera taught-in first will be displayed. You can switch between camera images by swiping horizontally.
- 2 Tap the [Camera] button again to switch the camera off.
- ✓ The camera has been switched off.

17.6

Door communication system menu

The Door communication section in the [Settings] view can have up to nine buttons. If the door communication system has not yet been configured, only the [Access data] button will appear in the system menu.

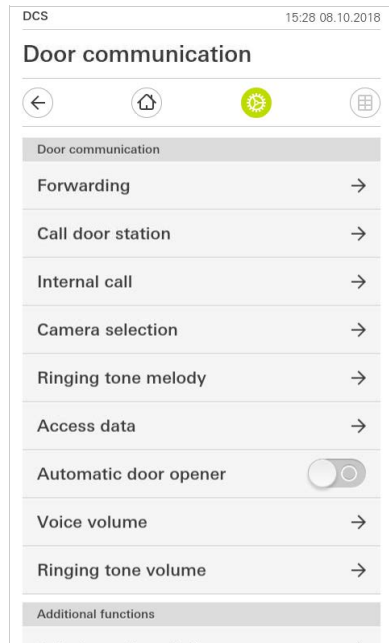

Figure 146
Door communication system menu

17.6.1

Forwarding

This function enables you to activate door call forwarding on a mobile phone.

**Note**

The forwarding function is only available on a Gira TCS-IP gateway of version 4.0 or higher.

- 1 Tap the [Forwarding] button.
- ✓ The [Activate forwarding] page opens. Here you can find a list of the call forwardings set up and assigned to the Gira G1.
- 2 Tap the call forwarding you wish to activate or tap [No forwarding] to deactivate call forwarding.
- 3 Tap the [OK] button.
- ✓ Call forwarding is activated or deactivated.
Active call forwarding is indicated by a symbol in the status bar [see 7.1].

17.6.2

Call door station

You can call a door station with this function.

- 1 Tap the [Call door station] button.
 - ✓ The [Call door station] page opens. Here you can find a list of the door stations assigned to the Gira G1.
 - 2 Tap the door station you want to call.
 - ✓ The call to the door station is established.
-

17.6.3

Internal call

Use this function to trigger an internal call, e.g. to call another home station in your house.

- 1 Tap the [Internal call] button.
 - ✓ The [Internal call] page opens. Here you can find a list of the internal calls assigned to the Gira G1.
 - 2 Tap the internal call you want to trigger.
 - ✓ The internal call is established.
-

17.6.4

Selecting a camera

- 1 Tap the [Camera selection] button.
 - ✓ The [Select camera] page opens. Here you can find a list of the cameras assigned to the Gira G1.
 - 2 Tap the camera you want to select.
 - ✓ The door communication view opens and the image from the selected camera is displayed.
-

17.6.5

Ringtone melody

Use this function to assign individual ringtone melodies to the door calls.

- 1 Tap the [Ringtone melody] button.
- ✓ The [Ringtone melody] page opens. Here you can find a list of the door stations assigned to the Gira G1.
- 2 Tap the call button of the door station for which you want to change the ringtone melody.
- 3 The [Select ringtone melody] page opens.
- 4 Tap the melody you want to hear.
- ✓ The melody is played.
- 5 Tap the [OK] button.
- ✓ The melody has been saved for this call button.
The [Ringtone melody] page opens.

17.6.6

Automatic door opener

The automatic door opener is used, for example, in medical practices where the door opener is to be automatically activated when a door station call button is pressed. If the automatic door opener is activated, the door opener is triggered approx. four seconds after a door call was made that has been assigned to the calling door station. If there are several door stations in the system, the automatic function automatically acts on the door opener of the door station from which the door call was triggered.



Important:
The door opens automatically

If the automatic door opener is activated, the door is automatically opened after a call is made. This permits people to enter the house unimpeded. Only activate the automatic door opener if you want to permit unimpeded access to the house.

- 1 Tap the [Automatic door opener] switch to activate or deactivate the automatic door opener.
- ✓ An active automatic door opener is indicated by a symbol in the status bar.
-

17.6.7

Access data

The access data for the door communication system is entered here. For this, a DCS communicator for the Gira G1 must first be set up using the TCS-IP gateway assistant. The user name and password data specified there are entered into the respective fields.

Additional information [see 15.2.1].

17.6.8

Voice volume

The voice volume is the volume at which the call with the door station is reproduced on the Gira G1.

**Tip****Carry out setting the volume with 2 people**

To check the volume level, one person should be at the Gira G1 and another person at the door station.

- 1 Tap the [Voice volume] button.
 - ✓ The [Change voice volume] page opens.
 - 2 Move the [Voice volume] slider to the desired value.
 - 3 Check the volume with a second person by asking the person to speak at the door station.
 - 4 Tap the [OK] button once the volume has been set correctly.
 - ✓ The voice volume has been set. The [Settings] view opens.
-

17.6.9

Ring tone volume

The ring tone volume is the volume of the ringtone melody that signals a door call on the Gira G1.

- 1 Tap on the [Ring tone volume] button.
- ✓ The [Ring tone volume] page opens.
- 2 Move the [Ring tone volume] slider to the desired value.
- ✓ When you lift off your finger, the ring tone is played at the set volume.
- 3 Tap the [OK] button once the volume has been set correctly.
- ✓ The ring tone volume has been set. The [Settings] view opens.

Setting up SIP door communication

The Gira G1 can be used as a home station in connection with a SIP-capable door station. If the door station supports video, the camera image can be displayed on the Gira G1 display. Communication is started at the touch of a finger. The favourites buttons can be used to call further door or home stations.

18.1

Connecting the Gira G1 to a SIP-capable door station

The Gira G1 is connected to the door communication system as a user interface. This is set up via the system menu and the Gira G1 device website. There are two ways in which the Gira G1 can be connected to a SIP-capable door communication system.

18.1.1

Direct connection

Direct connection enables the Gira G1 to be linked with a SIP-capable door station without any intermediate components.

Setup is carried out via the device website [siehe 22.2.2].

18.1.2

Connection via SIP server

The Gira G1 and SIP-capable door station are connected with a SIP server (registrar). Any number of additional SIP clients can be connected to the SIP server.

Setup is carried out via the device website [siehe 22.2.2].



Note

Multiple Gira G1 use

If multiple Gira G1 devices are used in connection with a SIP-capable door station, every Gira G1 must be set up via the device website. Connection data is not synchronised.

Operating SIP door communication

19.1

User interface structure

- 1 In the detail or tile view, tap on the door communication application.
✓ The door communication user interface opens.

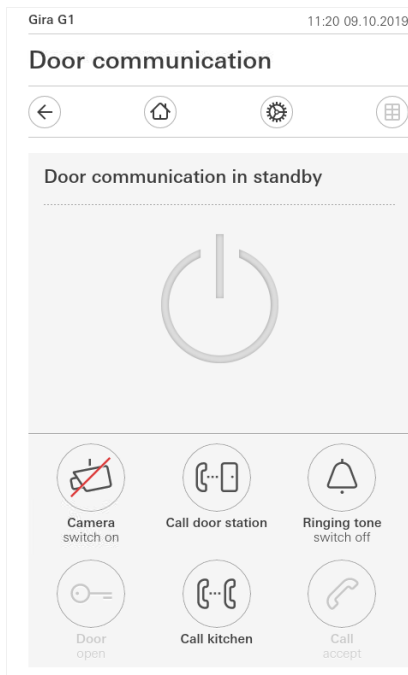

Figure 147
Door communication user interface.

The buttons have the following functions:

- Camera
Switches the camera image on a camera-capable door station on and off.
If several cameras are available, you can switch between the camera images by swiping horizontally across the camera video.
- Ringing tone
Switches the ringing tone on or off
If the ringing tone is off, the button is crossed out.
- Open door
Opens the door to which an active door call has been made.
- Call
Accepts an incoming call.
More details [siehe 19.2].

Note
Freely assignable buttons

The two buttons in the middle of the user interface can be assigned to any external or internal SIP contacts via the device website.

19.2

Managing calls

19.2.1

Accepting a call

In case of an incoming call, the [Door call] button illuminates green.

- 1 To accept the call, tap on the [Door call] button.
- ✓ The call has been accepted. The [Door call] button is illuminated during the intercom communication.

If the call comes from a video door station, the display module automatically shows the camera image.

If the call comes from an audio door station, "Door call" and "Accept call" appears on the display. In this case, the call can also be accepted with the [Door call] button.

 **Note:**
User interface

During a door call, the Gira G1 automatically switches to the door communication profile.

 **Note:**
Prioritisation of incoming calls

In case of a door call, any internal call that is currently being made is automatically terminated.

An incoming internal call will always be declined if an active door call or internal call is already being made.

19.2.2

Ending a call

During intercom communication, the [Door call] button illuminates red.

- 1 To end the call, tap on the [door call] button.
- ✓ The call ends. The [Door call] button illuminates green.

19.3

Deactivating the ringing tone

 **Important**
Only deactivate the ringing tone if necessary

Only deactivate the ringing tone in exceptional cases. Otherwise, you run the risk of not hearing the bell in an emergency, for example.

-
- 1 You can switch the ringing tone on and off using the [Ringing tone] button.
- ✓ If the ringing tone is off, the button is crossed out.

19.4

Opening the door

1. Tap on the [Door opener] button.

✓ The door opener is triggered.

**Note:****Only open the door during an active call**

The [Door opener] button is only available during an active door call and stored DTMF sequence.

- Store a DTMF sequence via the Gira G1 [siehe 19.6.7].
 - Store a DTMF sequence via the device website [siehe 22.2.5].
-

19.5

Switch on the camera

1 Tap on the [Camera] button.

✓ During an active door call the camera image is displayed. If the door station is inactive, a camera call is triggered. The camera image is displayed. If there are several cameras, the first camera to be configured will be displayed. By swiping horizontally, you can switch between camera images.

2 To switch off, tap on the [Camera] button again.

✓ The camera is switched off. When door call is active, audio transfer is still active until the door call is ended.

19.6 Door communication system menu

The door communication area in the [Settings] view can have up to seven buttons.

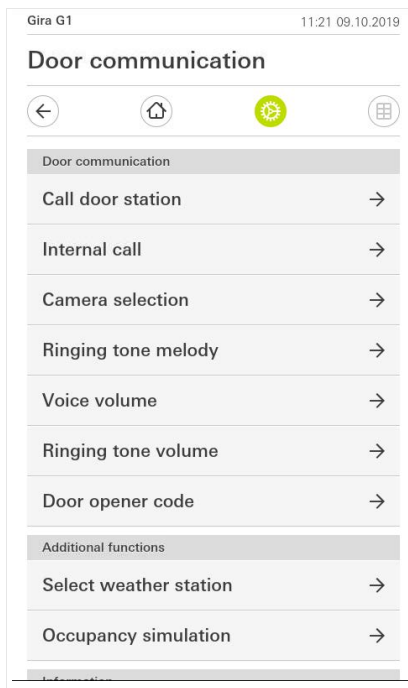

Figure 148
Door communication system menu

19.6.1 Call door station

You can use this function to call a door station.

- 1 Tap on the [Call door station] button.
✓ The [Call door station] page opens. Here you will find a list of the door stations assigned to the Gira G1.
- 2 Tap on the door station you want to call.
✓ The call to the door station is established.

19.6.2 Internal call

- 1 Tap on the [Internal call] button.
✓ The [Internal call] page opens. Here you will find a list of all home stations known to the Gira G1.
- 2 Tap on the home station you want to call.
✓ The internal call to the desired home station is established.

19.6.3

Camera selection

- 1 Tap on the [Camera selection] button.
 - ✓ The [Select camera] page opens. Here you will find a list of all door stations that support video.
 - 2 Tap on the camera you want to select.
 - ✓ The door communication view opens and the image of the selected camera is displayed. No audio is transmitted.
-

19.6.4

Ringling tone melody

You can use this function to assign pre-configured ringling tone melodies to the door calls.

- 1 Tap on the [Ringling tone melody] button.
 - ✓ The [Ringling tone melody] page opens. Here you will find a list of the door and home stations assigned to the Gira G1.
 - 2 Tap on the call button for the door station you wish to change the ringling tone melody for.
 - 3 The [Select ringling tone melody] page opens.
 - 4 Select the type of station.
 - 5 Select the station for which you want to set a melody.
 - 6 Tap on the melody you want to hear.
 - ✓ The melody will be played.
 - 7 Tap the [OK] button.
 - ✓ The melody is stored for this station.
- The [Ringling tone melody] page opens.
-

19.6.5

Voice volume

The voice volume is the volume at which the conversation with the door station is played back on the Gira G1.



Tip
Adjust the volume using two people

To check the volume, one person should stand in front of the Gira G1 and the other person in front of the door station.

- 1 Tap the [Voice volume] button.
- ✓ The [Change voice volume] page opens.
- 2 Move the [Voice volume] slider to the desired value.
- 3 Check the volume with the second person by asking them to speak into the door station during an active door call.
- 4 Tap the [OK] button if the volume is correctly set.
- ✓ The voice volume is set. The [Settings] view is open.

19.6.6

Ringling tone volume

The ringling tone volume is the volume of the ringling tone melody used to signal a call on the Gira G1.

- 1 Tap the [Ringling tone volume] button.
 - ✓ The [Ringling tone voice volume] page opens.
 - 2 Move the [Ringling tone volume] slider to the desired value.
 - ✓ Lift your finger to play the ringling tone at the set volume.
 - 3 Tap the [OK] button if the volume is correctly set.
 - ✓ The ringling tone volume is set. The [Settings] view is open.
-

19.6.7

Door opener

You can use this function to enter the door opener PIN for the door station in order to be able to use the door opener function.

- 1 Tap on the [Door opener] button.
- ✓ The [Door opener] page opens. Here you will find a list of the door stations assigned to the Gira G1.
- 2 Tap on the door station you want to configure.
- ✓ The input field for the door opener PIN opens.
- 3 Enter the door opener PIN which you configured in your door station earlier.
- ✓ The door opener function can now be used.

20

Weather forecast

With the weather forecast, you can call up weather data for up to five cities for the current and following two days.

20.1

Configuring the weather forecast

The weather forecast draws its data from Gira's online weather service. The Gira G1 must be connected to the internet in order for you to be able to use the weather forecast. The weather forecast function is configured and set on the Gira G1.

20.1.1

Adding a weather station

- 1 Open the [Settings] view.
- 2 Tap the [Select weather station] button.
- ✓ The [Add weather station] page opens.

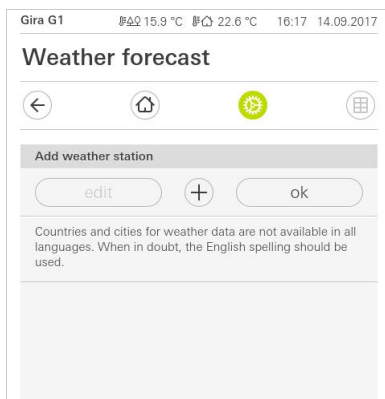

Figure 149

Add weather station

- 3 Tap the [+] button.
- ✓ The country input screen will appear.
- 4 Tap the [Country] input field and use the keyboard to enter at least the first two letters of the country in which the desired site is located.
- 5 Tap the [Search] button.
- ✓ A list of countries will appear.
- 6 Tap the country that you were looking for.
- 7 Tap the [Next] button.
- ✓ The city input screen will appear.
- 8 Tap the [City] input field and use the keyboard to enter at least the first three letters of the city that you are looking for in the [City] input field (alternatively, in the case of German cities you can search by postcode).
- 9 Tap the [Search] button.
- ✓ A list of cities will appear.
- 10 Tap the city that you were looking for.
- 11 Tap the [OK] button.
- ✓ The [Add weather station] page opens. The weather station is shown on the list.

20.1.2

Changing the order of weather stations

- 1 Open the [Settings] view.
 - 2 Tap the [Select weather station] button.
 - ✓ The [Add weather station] page opens.
 - 3 Place your finger on the shifting point in front of the weather station and move the weather station into the order you want.
 - 4 Tap the [OK] button.
 - ✓ The order of the weather stations has now changed. The [Settings] view opens.
-

20.1.3

Deleting a weather station

- 1 Open the [Settings] view.
- 2 Tap the [Select weather station] button.
- ✓ The [Add weather station] page opens.
- 3 Tap the [Edit] button.
- ✓ Instead of shifting points, you will see activation check boxes.
- 4 Tap the weather station that you want to delete.
- ✓ A red tick mark will appear in the check box. The red [Delete] button is shown.
- 5 Tap the [Delete] button.
- ✓ The weather station will be deleted.
- 6 Tap the [OK] button.
- ✓ Shifting points will be displayed again instead of activation check boxes.

20.2

Reading weather data

- 1 Tap the weather station button.
- ✓ The online weather service will open the first selected weather station. Here you will be able to see the weather data for the current and following two days.



Figure 150
Reading weather data

- 2 Tap the [i] button for more detailed information on the weather.
- 3 Swipe horizontally to view the data for the other selected weather stations.

21

Firmware update

21.1

Adding firmware

Firmware updates for the Gira G1 are performed using the Gira Project Assistant. The new firmware must be added to the Gira Project Assistant before it can be loaded onto the Gira G1.

You can store different firmware versions for your devices in the Gira Project Assistant so that you can then load them onto the corresponding devices in the "Action Center" view.

You can find an overview of the available firmware versions in the "Settings" - "Firmware" view.

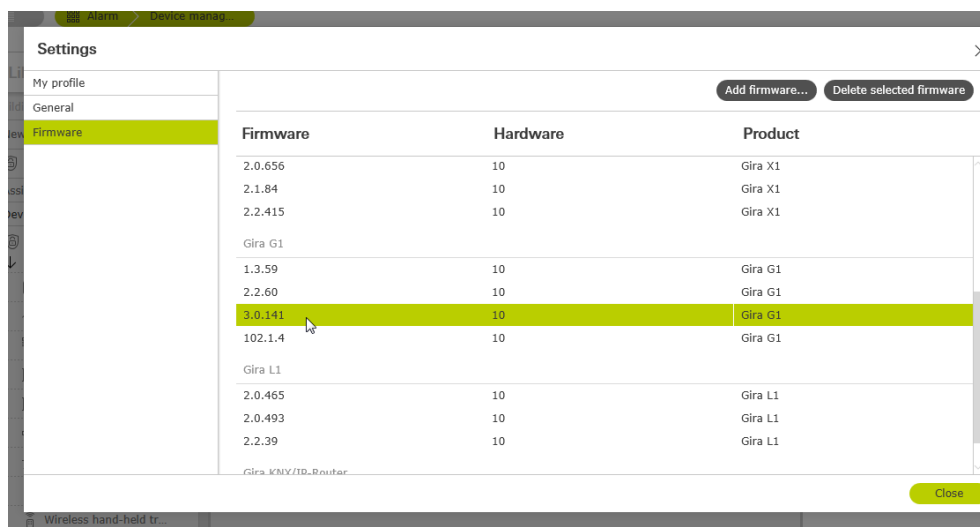

Figure 151
Gira Project Assistant
Settings -
Firmware

21.1.1

Adding firmware manually

To add new firmware to the list in the Gira Project Assistant manually, proceed as follows:

- 1 Download a new firmware version from the Gira website.
- 2 Place the downloaded ZIP file in a file folder which you can access.
- 3 Open the "Settings" view in the main menu of the Gira Project Assistant.
- 4 Click "Firmware" in the "Settings" dialog.
- 5 Click "Add firmware".
- 6 Select the desired firmware file (ZIP file) in the dialog that opens and then click "Open".
- ✓ The firmware is now available in the Gira Project Assistant for updating devices.
- 7 Exit the dialog by clicking "Close".

21.1.2

Adding firmware automatically

As soon as a new firmware version is available, this will be shown in the GPA. Simply click on the link in the message if you wish to add this new firmware into the GPA. The firmware will then be downloaded automatically, and will be available for updating devices in the maintenance centre.

21.2

Installing firmware

The new firmware is installed in the "Action Center" view of the Gira Project Assistant.

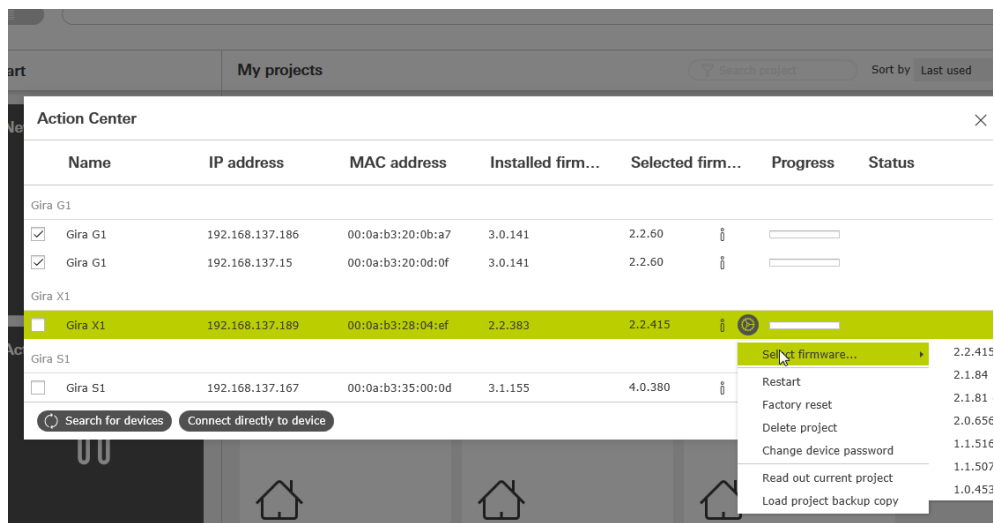

Figure 152
Gira Project Assistant
Action Center

To load the new firmware onto the Gira G1, proceed as follows:

- 1 Open the "Action Center" view in the Gira Project Assistant.
 - 2 The view that opens displays all the devices found on your network.
 - 3 Select the Gira G1 by selecting the corresponding selection box.
 - 4 Click the gear symbol and then "Select firmware" to select the firmware version.
 - 5 Select the desired firmware version.
 - 6 To load the firmware onto the device, click "Start update".
- ✓ After installation, the Gira G1 restarts and shows the start screen of the Gira G1.

Loading firmware
onto a device

Device website

The device website enables access to the Gira G1 via the IP network.

- 1 Enter the Gira G1's IP address in the address bar of your browser.
- ✓ The device website opens and you will be asked to enter the password.
- 2 Enter the Gira G1 device password.
- ✓ You can now use the functions of the device website.

The device website offers the following functions:

Device information:

- Date and time display
- Network properties display

SIP door communication:

- Import and export of configuration files [siehe 22.2.1]
- Network definition [siehe 22.2.2].
- Editing SIP participants [siehe 1].
- Adding SIP participants [siehe 22.2.5].
- Assigning favourites buttons [siehe 22.2.6].

Diagnosis:

- Information on storage space, file system and processes.
- Executing a restart [siehe 22.3.1].
- Factory settings [siehe 22.3.2].
- Programming mode [siehe 22.3.3].
- Downloading log files [siehe 22.3.4].
- Extended logging [siehe 22.3.5].

22.1

Device information

The [Device information] tab on the device website displays the date and time, as well as the network properties of the Gira G1.



Bild 153
Device information
device website

22.2

SIP door communication

The [SIP door communication] tab on the device website is used to set up SIP-capable door communication devices.

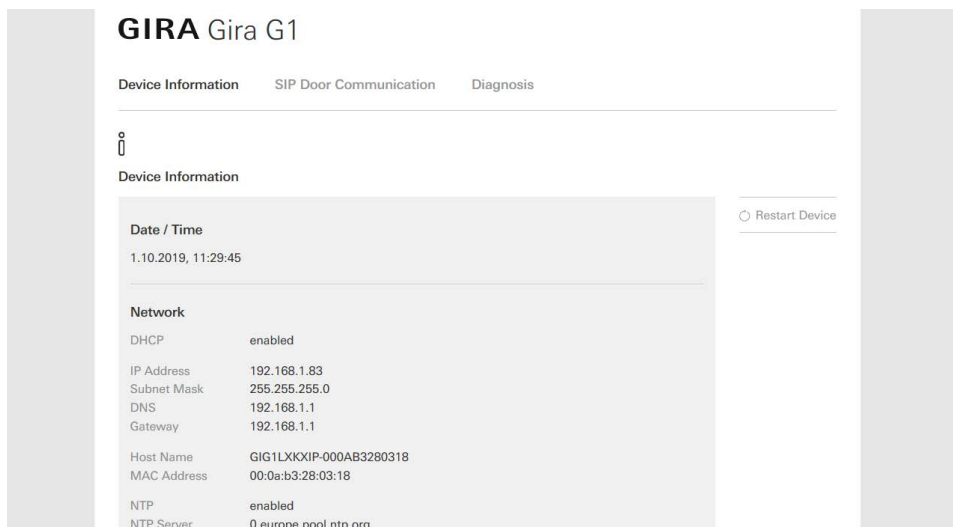
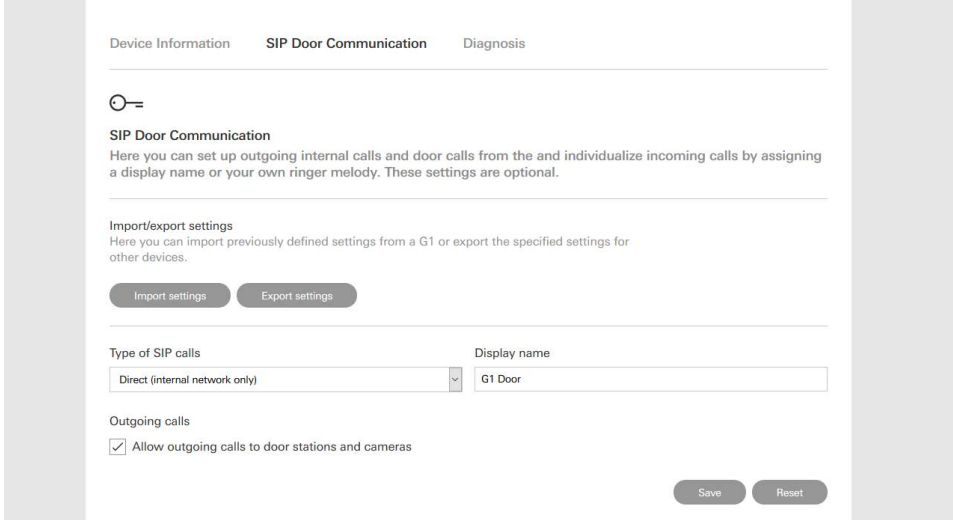

The screenshot shows the 'SIP Door Communication' tab selected in a navigation menu. The page title is 'SIP Door Communication'. Below the title, there is a sub-header 'SIP Door Communication' and a paragraph: 'Here you can set up outgoing internal calls and door calls from the and individualize incoming calls by assigning a display name or your own ringer melody. These settings are optional.' Below this, there is a section 'Import/export settings' with a paragraph: 'Here you can import previously defined settings from a G1 or export the specified settings for other devices.' There are two buttons: 'Import settings' and 'Export settings'. Below this, there are two input fields: 'Type of SIP calls' with a dropdown menu showing 'Direct (internal network only)' and 'Display name' with a text input field containing 'G1 Door'. Below these, there is a section 'Outgoing calls' with a checked checkbox 'Allow outgoing calls to door stations and cameras'. At the bottom right, there are two buttons: 'Save' and 'Reset'.

Bild 154

SIP
door communication
Device website

22.2.1

Import/export settings

- If you have already created SIP configuration files in another project and would like to continue using them, click on [Import settings].
- If you would like to connect several Gira G1s with the same configuration to the SIP door communication system, click [Export settings].

22.2.2

Setting up a SIP network

There are two ways in which the SIP door communication system can be used.

- “Direct call” requires an IP connection between the Gira G1 and the SIP door communication system. Under [Type of SIP calls], select “Direct call (internal network only)” and assign a display name.
- “Registrar” requires a third-party SIP server, via which the SIP participants are connected. Under [Type of SIP calls], select “Registrar” and fill in the following input mask.

Import/export settings
Here you can import previously defined settings from a G1 or export the specified settings for other devices.

Import settings Export settings

Type of SIP calls: Registrar (dropdown) | Display name: G1 Door (text field)

SIP server address: 192.168.178.1 (text field) | SIP server port: 5060 (text field)

Username: g1 (text field) | Password: ***** (password field)

Authentication name: G1 Entrance (text field) | Registration interval (seconds): 600 (text field)

Outgoing calls
 Allow outgoing calls to door stations and cameras

Save Reset

Bild 155
Registrar SIP
door communication

- 1 In the [Display name] field, enter a name for the SIP participant.
- ✓ The display name is sent when a call is made and can be displayed on the called device.
- 2 In the [SIP server address] field, enter the IP address of the SIP server.
- 3 In the [SIP server port] field, enter the port number of the SIP server. The standard port number for SIP communication is 5060.
- 4 In the [User name] field, enter the user name of our SIP client account.
- 5 In the [Password] field, enter the password of your SIP client account.
- 6 In the [Authentication name] field, enter the authentication name of your SIP client account.
- ✓ If no authentication name has been assigned, the user name will be used for authentication.
- 7 In the [Registration interval (seconds)] field, select your preferred interval for SIP server registration.

22.2.3

Outgoing calls

If you wish to allow the Gira G1 to make outgoing door and camera calls, activate the [Allow outgoing door and camera calls] button.

If you deactivate the [Allow outgoing door and camera calls] button, this Gira G1 will not be able to initiate any outgoing door or camera calls. Incoming calls are not affected by this.

22.2.4

Added SIP participants

The “Added SIP participants” view lists the SIP participants connected to the Gira G1. You have the option of changing ringing tones and editing or deleting SIP subscribers.



Bild 156
Display SIP
participants

22.2.5

Adding SIP participants

Click on the [Add SIP participants] button to add further SIP participants to your network.

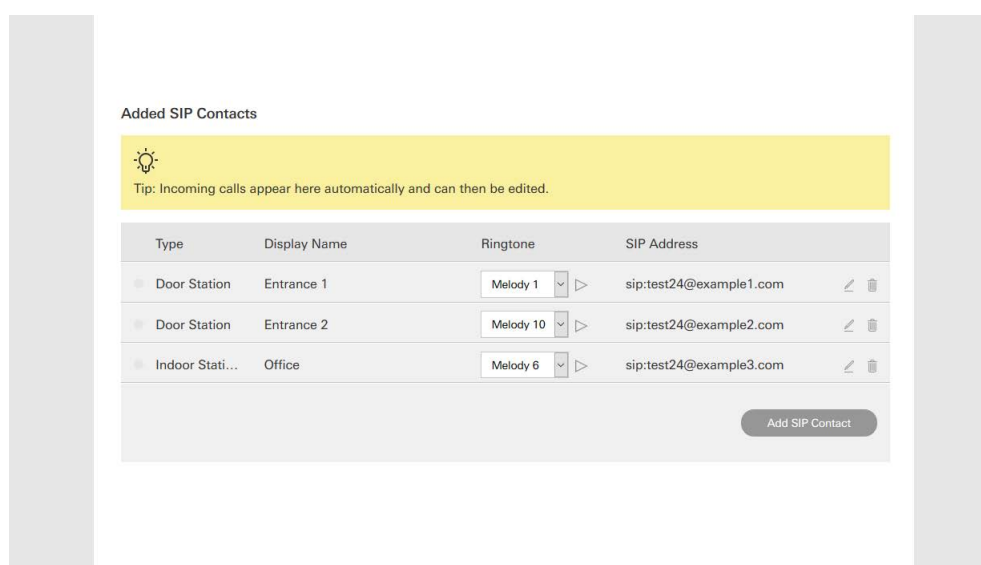
You have the option of defining the SIP participant as a door station or a home station. The selection as a door station offers you the option of setting a door opener code and activating the camera function.

When configuring your SIP door station, define a door opener PIN (DTMF sequence). In the field [Door opener code], enter the door opener PIN for your SIP door station in order to be able to use the "Open door" function in the Gira G1 user interface.

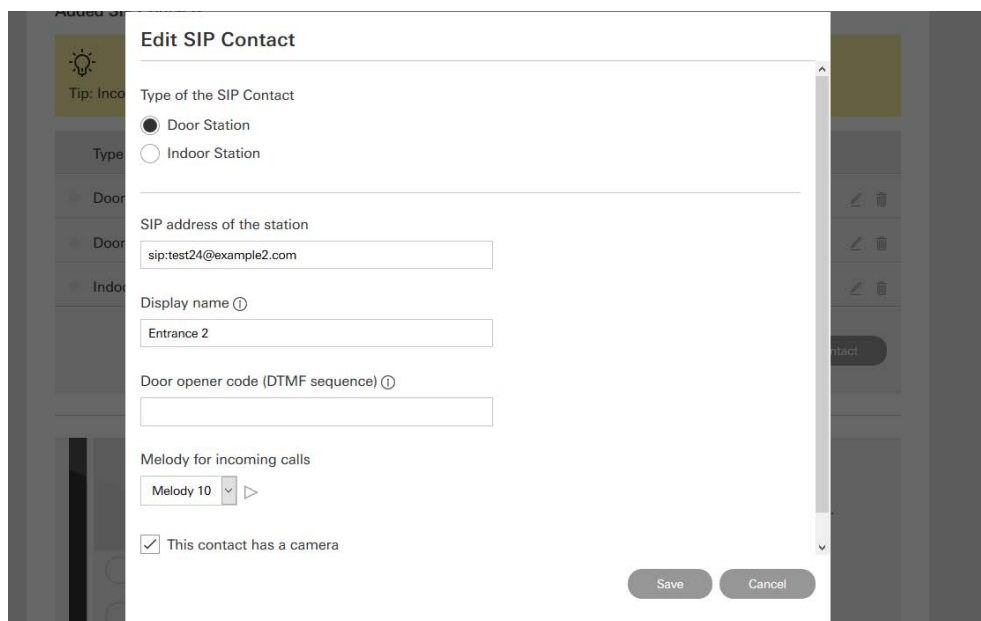

Edit SIP Contact

Type of the SIP Contact

Door Station

Indoor Station

SIP address of the station

sip:test24@example2.com

Display name ⓘ

Entrance 2

Door opener code (DTMF sequence) ⓘ

Melody for incoming calls

Melody 10 ▶

This contact has a camera

Save Cancel

Bild 157
Adding SIP
participants

22.2.6

Favourites buttons

Using the favourites buttons, you have the option of creating speed dial keys for calls to door stations and home stations. The participants listed under "Added SIP participants" will be available for selection in the drop-down menu. The display name is shown under the respective favourites buttons in the Gira G1 user interface.



Bild 158
Favourites buttons

22.3

Diagnosis

The [Diagnosis] tab on the device website provides information on memory capacity, system utilisation and device details.

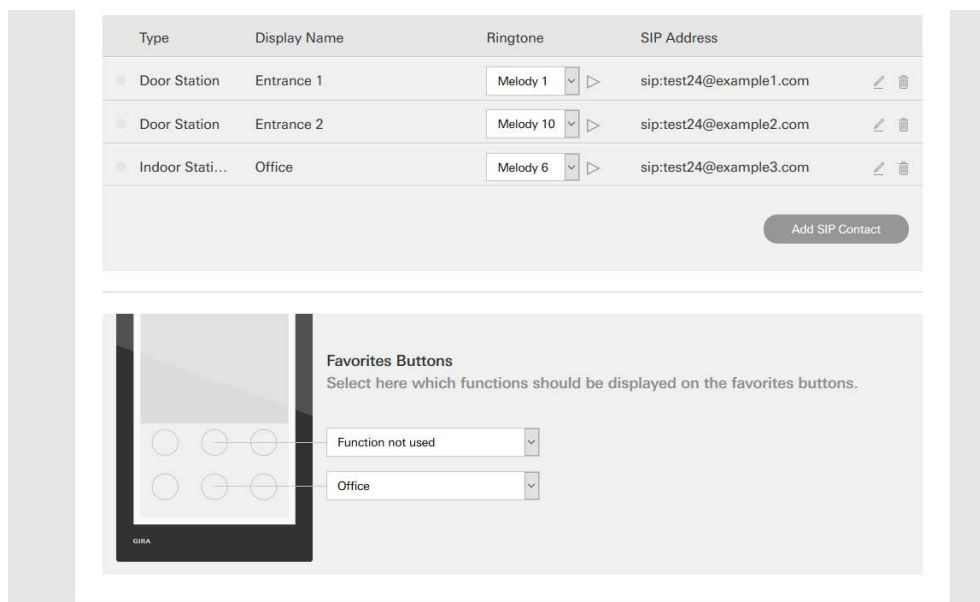
The buttons on the right offer the following functions:

Device Information SIP Door Communication **Diagnosis**

Diagnosis

Memory

```
Virtual: 139.41 MB
Resident: 25.17 MB
Shared: 16.03 MB
Text: 0.07 MB
Lib: 0.00 MB
Data: 111.89 MB
Dirty: 0.00 MB
```

Filesystem

Filesystem	1K-blocks	Used	Available	Use%	Mounted on
/dev/mmcblk0p2	991612	899804	360608	63%	/
none	402012	0	402012	0%	/dev
proc	0	0	0	0%	/proc
devpts	0	0	0	0%	/dev/pts
tmpfs	507448	9548	497900	2%	/dev/shm
tmpfs	507448	764	506684	0%	/tmp
tmpfs	507448	296	507152	0%	/run
sysfs	0	0	0	0%	/sys
/dev/mmcblk0p1	10871	170	10807	2%	/opt/extparam
/dev/mmcblk0p4	1743136	27668	1625266	2%	/opt/userdata

Processes

```
Mem: 395016K used, 619884K free, 10612K shrd, 18784K buff, 117276K cached
CPU: 0% usr 9% sys 0% nic 90% idle 0% io 0% irq 0% sirq
Load average: 0.04 0.14 0.13 1/226 21905
PID PPID USER STAT VSZ %VSZ %CPU COMMAND
```

Functions

- Restart Device
- Factory Reset
- Programming mode

Logging

- Download log files
- Extended Logging

Bild 159
Device website
Diagnosis.

22.3.1

Restart

To restart the Gira G1, proceed as follows:

- 1 Click on [Execute a restart].
- ✓ The [Restart] confirmation dialogue opens.
- 2 Click on [OK] to restart the Gira G1.
- ✓ The Gira G1 restarts.

22.3.2

Factory settings

To reset the Gira G1 to factory settings, proceed as follows:

- 1 Click on [Factory settings].
 - ✓ The [Factory settings] confirmation dialogue opens.
 - 2 Click on [OK] to reset the Gira G1 to factory settings.
 - ✓ The Gira G1 is reset to factory settings and all configurations are deleted.
-

22.3.3

Programming mode

The programming mode serves to program the Gira G1 in the ETS.

- 1 Click on [Programming mode].
- ✓ The Gira G1 is set to programming mode.*

* Only in the configuration as KNX room operating device.

22.3.4

Download log files

- 1 Click on [Download log files].
 - ✓ The browser's download dialogue will open.
 - 2 Select [Save file] and confirm with [OK].
 - ✓ The log files are downloaded.
-

22.3.5

Extended logging

By activating [Extended logging], additional system data is collected, which is summarised in the log files.

Appendix

23.1

Error messages

The warning symbol is displayed in the status bar for error messages. In most cases an interrupted network connection is the source of the error. First check the network connection of the Gira G1.

Other error messages are listed below:

- "The connection to the DCS-IP gateway has been interrupted."
Indicates a loss of connection after setting up the door communication function. Check the network connection to the DCS-IP gateway.
- "Login failed."
Check the entered user name and password for the DCS communicator that was set up for the Gira G1.
- "The DCS-IP gateway is not available."
Check the connection to the DCS-IP gateway.
- "Error connecting to the DCS-IP gateway."
Indicates a loss of connection after setting up the door communication function. Check the connection to the DCS-IP gateway.
- "The network connection has been interrupted."
Check the connection of the Gira G1 with the network.
- "The Weather Service is unreachable."
Check the internet connection of the Gira G1.
- Wrong date and time displayed, weather forecast not functional.
If the [Weather] function and the date and time display do not work correctly, please check if a DNS server has been entered in the network settings.

23.2

Manual device restart via magnet

Should the Gira G1 stop reacting, you can restart the Gira G1 using a commercially available magnet:

- 1 Place the magnet in front of the Gira logo of the Gira G1 for approx. 3 s.
- ✓ The Gira G1 restarts, the configuration is retained.

23.3













































Anonymous usage statistics

















































- The Gira G1 transmits the firmware version and device type to a Gira server daily. The following information is transmitted:

















































```
{"config":{"doorcomm":"gira","mode":"visu-client","weather":"yes"},  
"firmwareVersion":"3.2.66.0","model":"GIG1LXKXIP","uuid": "473d3f67-  
c280-12345-a1db-c963619f94ab","version":1}
```
- The data transferred is transmitted anonymously in encrypted format, ensuring privacy is optimally protected at all times.
- This data transfer forms the necessary basis for providing end users with automatic future updates, such as security updates.

















































23.4

List of available symbols















































1	Lighting		23	Bathroom	
2	Sun		24	Living room	
3	Night		25	Library	
4	Favourites		26	Balcony	
5	Door		27	Bathtub	
6	Window		28	Shower	
7	Blind		29	Home office	
8	Open lock		30	Bedroom	
9	Closed lock		31	Hotel	
10	Open door		32	Exercise room	
11	Heating		33	Workshop	
12	Gas-fired boiler		34	Garage	
13	Gas flame		35	Loading ramp	
14	Temperature		36	Garden	
15	Socket outlet		37	Flower	
16	Dining room		38	Tool	
17	Kitchen		39	Swimming pool	
18	Hall		40	Whirlpool	
19	Children's room		41	Sauna	
20	Playroom		42	Staircase	
21	Baby-care room		43	Poolroom	
22	Wine cellar		44	Laundry	

45	Hot plate		69	Alarm	
46	Watering		70	Eye	
47	Watering can		71	Film	
48	WC Male		72	Music	
49	WC Female		73	Media	
50	WC		74	Scene	
51	Heating		75	Romantic	
52	Cooling		76	Heart	
53	Water tap		77	Party	
54	Floor plan		78	Komfort	
55	Storey		79	Standby	
56	Adjoining building		80	Presentation	
57	Parking deck		81	RGB colour picker	
58	Parking place		82	Electric iron	
59	Wardrobe		83	Forklift	
60	Conference room		84	Car	
61	Lift		85	Helicopter	
62	Solar collector		86	Camera	
63	House		87	Emergency exit	
64	Factory		88	Escape	
65	Office building		89	Holiday	
66	Weather station		90	Consumption values	
67	Barrier		91	Diagrams	
68	Shopping cart		92	Bell	

93	Clock		117	No smoking	
94	Timer		118	Manual function	
95	Calendar		119	Manual actuation	
96	Settings		120	Fan	
97	Frost protection		121	Funct. folders	
98	Cooling/heating		122	Room functions	
99	Ground heat		123	Wish list	
100	Tablet		124	Funnel	
101	TV		125	Magnifying glass	
102	IT		126	Cloudy	
103	Internet		127	Rain	
104	Globe		128	Eco mode	
105	Memory card		129	Automation	
106	Email		130	Receiver	
107	User profile		131	On-off switch	
108	Information		132	Outdoor area	
109	Save		133	Part of building	
110	Calculator		134	Switch cabinet	
111	Dog		135	Cellar	
112	Cow		136	Ground floor	
113	Warning		137	Storey	
114	High rack		138	Attic	
115	Message		139	Room	
116	Smoking area		140	Break room	

141	Kitchenette		165	Remote control	
142	Reception		166	Repeater	
143	Cafeteria		167	Smoke alarm device	
144	Front door		168	Technical detector	
145	Keywords		169	Door module	
146	Patio		170	Glass-breakage detector	
147	Telephone		171	Operation unit	
148	Mobile telephone		172	Alarm control unit	
149	Fax		173	Indoor siren	
150	Dot		174	Outdoor siren	
151	Winter garden		175	Magnetic contact	
152	Close		176	Hand-held transmitter assault	
153	Reset		177	Error	
154	Plus		178	Change history	
155	Link		179	Tested, selected	
156	Caps Lock key		180	Change colour	
157	LED signal light		181	Note	
158	DRA		182	Important information	
159	I/O module		183	Main menu	
160	I/O module input		184	Context menu	
161	I/O module output		185	Change sequence	
162	Motion detector		186	Project scope	
163	Motion detector with camera		187	Rename	
164	Power supply		188	Delete	

189	Whole page width		213	Elapsed operating time meter	
190	Navigation arrow		214	Hysteresis	
191	Selection / jump to first entry		215	Multiplexer	
192	Selection / jump to last entry		216	Inverter	
193	Selection / forward, play		217	Comparator	
194	Selection / backward		218	On/off delay	
195	Channel		219	OR gate	
196	Datapoint		220	Oscillator	
197	Source		221	PI controller	
198	Checked, OK		222	PID controller	
199	Draft		223	Random generator	
200	Note		224	Separating plate	
201	Quick		225	Send-by-change	
202	Slow		226	Covering	
203	Keypad		227	Timer folder	
204	Logic		228	Staircase light	
205	AND		229	Value generator	
206	Type converter		230	XOR	
207	Counter		231	Sunrise	
208	Telegram delayer		232	Press, touch	
209	Demultiplexer		233	User	
210	Lock-out		234	User group	
211	Edge detector		235	Administrator	
212	Heating/Cooling		236	Installer	

237	Security area 1, main security area		260	Fire	
238	Security area 2		261	Medical alarm	
239	Security area 3		262	Internally activated alarm	
240	Security area 4		263	Alarm forwarding	
241	Security area 1 multiple		264	Panic alarm	
242	Security area 2 multiple		265	Alerting rule	
243	Security area 3 multiple		266	Tamper alarm	
244	Security area 4 multiple		267	Supervision alarm	
245	I/O module contact open		268	Technical alarm	
246	Message / mobile telephone		269	Vital monitoring	
247	Message / IP, internet		270	Technical alarm	
248	Message / telephone		271	Press	
249	Message		272	Bookmark	
250	Message / voice message		273	Page	
251	Externally activated		274	Export document	
252	Internally activated		275	Medal	
253	Internally and externally activated		276	Manual alarm	
254	Alarm		277	Security guard	
255	Outgoing call		278	Device in building	
256	Externally activated event		279	Alarm in building	
257	Internally activated event		280	Help video	
258	Externally activated alarm		281	Marked corner	
259	Bell		282	Alarm system settings	

283	Logic Editor		306	Network folder	
284	Security areas		307	MP3 player	
285	Timers and scenes		308	Radio	
286	Visualisation		309	Speaker	
287	Commissioning		310	User 1	
288	Help / question		311	User 2	
289	Left arrow		312	Action Center	
290	Right arrow		313	Changeover switch	
291	Arrow / redo		314	NC contact	
292	Arrow / undo		315	NO contact	
293	Scene set		316	12V output	
294	Information, messages		317	0V output	
295	Subsystems		318	Gira G1	
296	Percent		319	Urgent technical alarm	
297	Roof window		320	Green tick	
298	Server		321	Question	
299	Bluetooth		322	Download	
300	CD				
301	Selection / jump to first entry				
302	Selection / jump to last entry				
303	Input				
304	Input jack				
305	Lower volume				

23.5 Gira G1 design

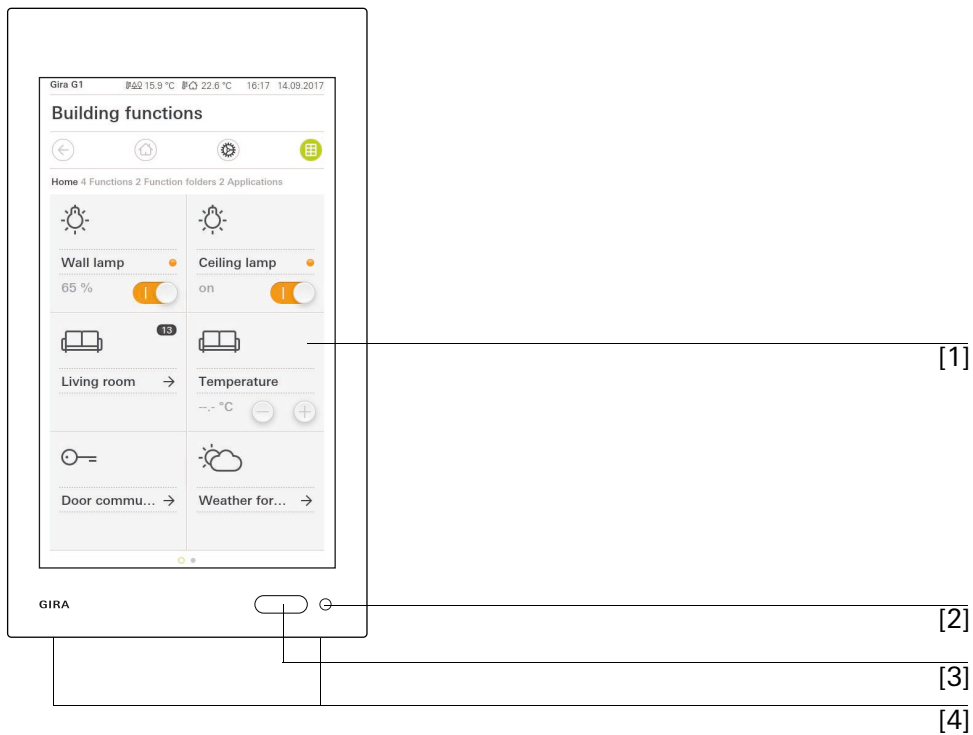

Figure 160
Front view

- [1] Touch screen
- [2] LED
- [3] Proximity sensor
- [4] Microphone

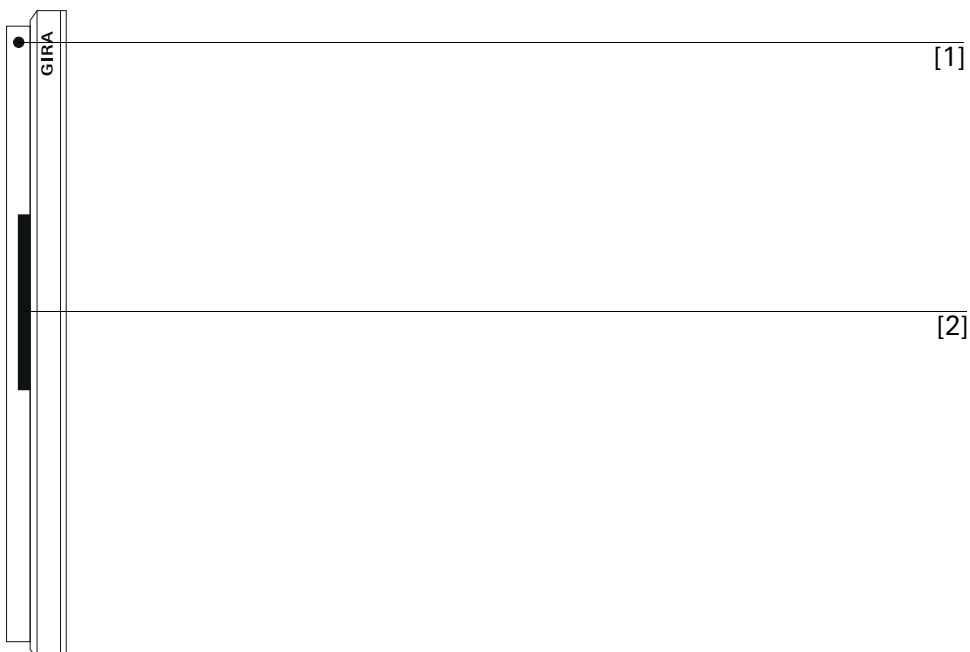

Figure 161
Side view

- [1] Unlocking opening
- [2] Sound channel

23.6

Gira G1 dimensions

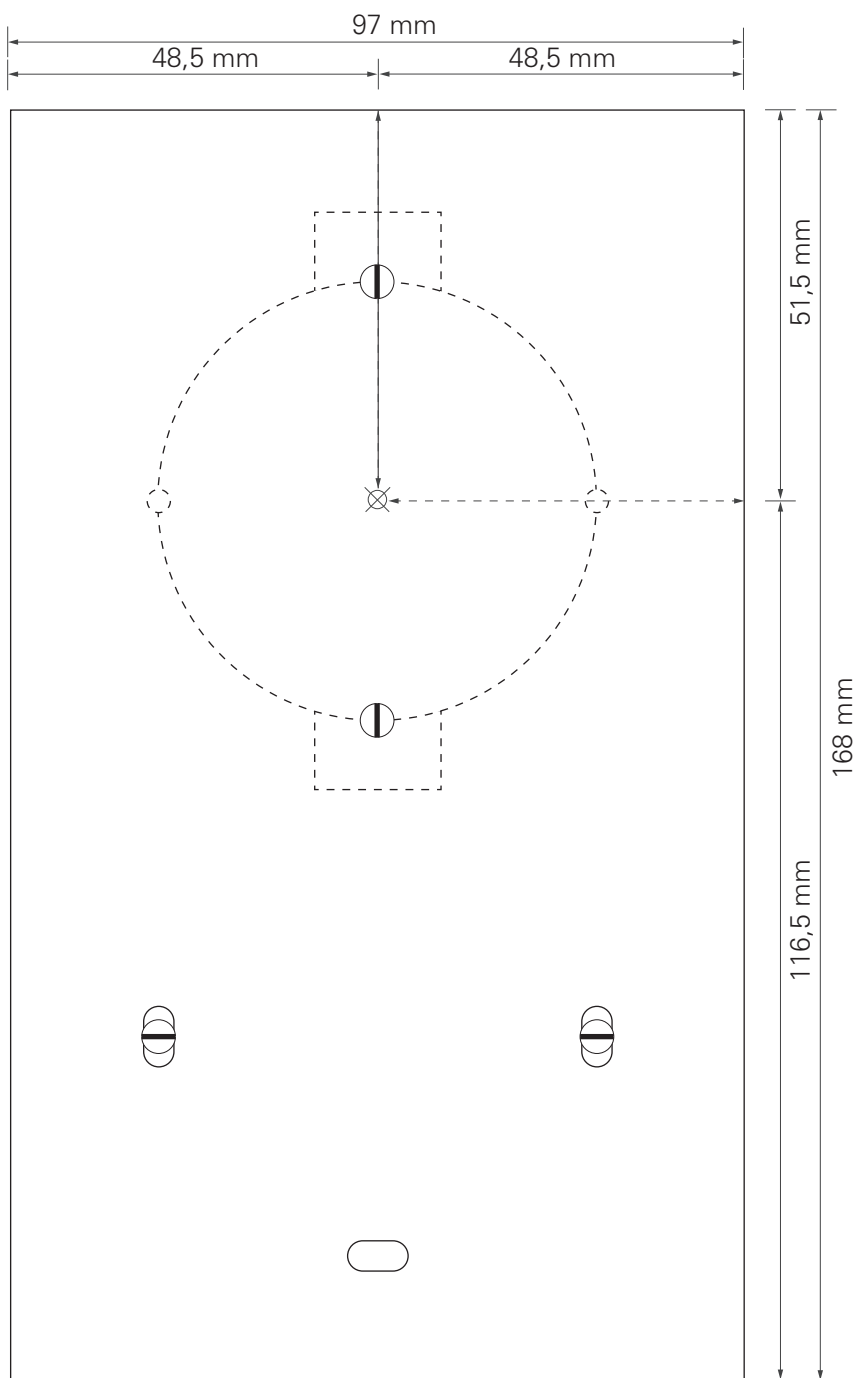

Figure 162
Dimensions
Gira G1

23.7

PoE connection module terminal assignment

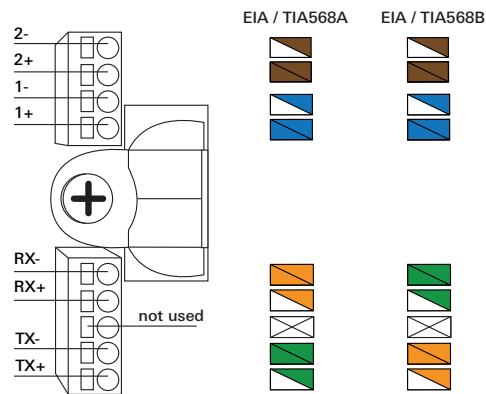

Figure 163
Terminals
PoE connection module

24

Warranty

The warranty is provided in accordance with statutory requirements via the retailer.

Please submit or send faulty devices postage paid and with an error description to your sales representative (retailer / installation company / electrical contractor).

They will forward the devices to the Gira Service Centre.