

Issue:
29.08.2022
20153200

Dimming actuator, 4-gang Standard

Order no. 2015 00



Table of Contents

1	Information on the product	4
1.1	Product catalogue	4
1.2	Function	4
1.3	Device components	6
1.4	Technical data.....	7
1.5	Accessories.....	8
2	Safety instructions	9
3	Mounting and electrical connection	10
4	Troubleshooting	12
5	Commissioning	15
6	Application programs	17
7	Scope of functions	18
8	Notes on software	19
9	Operation and indication	20
9.1	Button operation and indication functions	20
9.2	ETS configuration	23
9.2.1	Manual operation	23
9.2.2	Status indication	26
9.3	Operation and indication parameters.....	28
9.4	Operation and indication object list.....	30
10	Dimming operation	31
10.1	Channel configuration	31
10.1.1	Channel configuration parameters	32
10.1.2	Channel configuration object list.....	33
10.2	Name of the dimming channel	34
10.2.1	Name of the dimming channel parameters.....	35
10.3	Defining load type	36
10.3.1	Load type parameter	39
10.4	Operation with universal power booster (OLD).....	40
10.4.1	Parameter operation with universal power booster (OLD)	41
10.5	Dimming characteristic.....	42
10.5.1	Parameter Dimming characteristic	48
10.6	Brightness range.....	50
10.6.1	Brightness range parameter	52

10.7	Switching / dimming behaviour	53
10.7.1	Switching/dimming behaviour parameters.....	56
10.8	Times	58
10.8.1	General times parameter	58
10.9	Reset behaviour.....	59
10.9.1	Reset behaviour parameters	61
10.10	Channel-oriented feedback.....	62
10.10.1	Switching status feedback	62
10.10.2	Brightness value feedback	65
10.10.3	Feedback telegrams parameter.....	68
10.10.4	Feedback object list.....	71
10.11	Time delays.....	72
10.11.1	Time delays parameters	73
10.12	Scene function	74
10.12.1	Scene function parameters.....	77
10.12.2	Object list scene function.....	80
10.13	Staircase function	81
10.13.1	Staircase function parameters	89
10.13.2	Object list staircase function.....	92
10.14	Logic operation function.....	93
10.14.1	Logic operation function parameters	95
10.14.2	Object list logic operation function.....	96
10.15	disabling function	97
10.15.1	Disabling function/forced position parameter	98
10.15.2	Disabling function/forced position object list.....	101
11	As-delivered state	102

1 Information on the product

1.1 Product catalogue

Product name: Dimming actuator, 4-gang Standard

Use: Actuator

Design: RMD

Order no. 2015 00

1.2 Function

The universal dimming actuator works according to the leading edge phase control or trailing edge phase control dimming principle and makes switching and dimming of incandescent lamps, HV halogen lamps and LV halogen lamps possible by means of conventional transformers and Tronic transformers, and dimmable HV LEDs and LV LEDs by means of electronic or conventional transformers or compact fluorescent lamps.

The characteristic of the connected load - provided that the load is supported - can be automatically measured separately for each output channel and the appropriate dimming procedure can be set. Alternatively, it is possible to predefine the dimming procedure using the ETS configuration. This procedure is necessary for loads that do not enable automatic calibration (e.g. with compact fluorescent lamps). 4 dimming channels are available. To simplify the configuration, all existing dimming channels can be assigned to the same parameters in the ETS and thus configured identically. The number of parameters is thereby reduced in the ETS and applied automatically on all channels.

The device permits the separate feedback of the individual switching and brightness statuses of the connected loads to the KNX.

The pushbuttons on the front panel of the device allow the dimming channels to be switched on or dimmed by manual operation in parallel with the KNX in a non-programmed state. This feature permits fast checking of connected loads for proper functioning.

The function features that are independently adjustable for every dimming channel by means of the ETS include, for example, separately configurable brightness ranges, extended feedback functions, a logic operation function, separately adjustable dimming behaviour, soft dimming functions, time delays and a staircase function with pre-warning before switching off the lighting.

Furthermore, each dimming channel can be integrated in up to 16 scenes with various brightness values. Central switching of all channels is possible, too. Moreover, the brightness values of the dimming channels in case of bus voltage failure or bus voltage return and after ETS programming, can be preset separately.

The device can be updated. Firmware can be easily updated with the Gira ETS Service App (additional software).

The device is KNX Data Secure capable. KNX Data Secure offers protection against manipulation in building automation and can be configured in the ETS project. Detailed specialist knowledge is required. A device certificate, which is attached to the device, is required for safe commissioning. During mounting, the certificate must be removed from the device and stored securely.

Planning, installation and commissioning of the device are carried out with the aid of the ETS, version 5.7.3 and above or of the ETS6.

The device electronics are supplied exclusively from the bus voltage. The device is designed for mounting on DIN-rails in closed compact boxes or in power distributors in fixed installations in dry rooms.

1.3 Device components

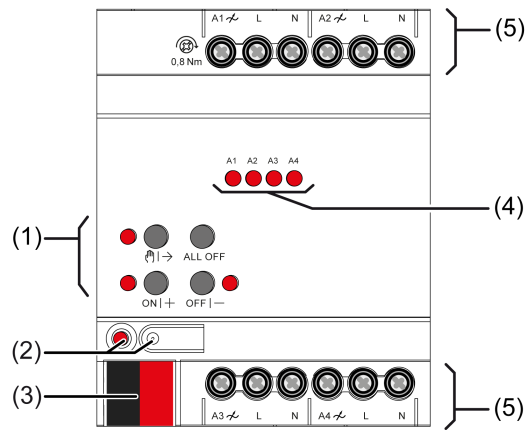





Image 1: Device components

- (1) Button field for manual operation
- (2) Programming button and LED
- (3) KNX connection
- (4) Status LEDs for outputs
- (5) Load connections

1.4 Technical data

Rated voltage	AC 110 ... 230 V ~
Mains frequency	50 / 60 Hz
Power loss	max. 7 W
Standby power	approx. 0.16 W per channel
Ambient temperature	-5 ... +45 °C
Storage/transport temperature	-25 ... +70 °C

Connected load per channel depends on the connected lamps and the set load type:
(see figure 2), (see figure 3)

	ETS parameter load type
UNI	universal (with automatic calibration procedure)
	conv. transformer (inductive / leading edge phase control)
LED 	LED (leading edge phase control)
	electr. transformer (capacitive / trailing edge phase control)
LED 	LED (trailing edge phase control)











	 LED	 LED	 LED
230V			
	W	W	VA
UNI	1 ... 35	20 ... 100	20 ... 100
	—	—	20 ... 100
LED 	1 ... 35	20 ... 100	—
	1 ... 200	20 ... 200	—
LED 	1 ... 200	20 ... 200	—
110V			
	W	W	VA
UNI	1 ... 18	20 ... 50	20 ... 50
	—	—	20 ... 50
LED 	1 ... 18	20 ... 50	—
	1 ... 100	20 ... 100	—
LED 	1 ... 100	20 ... 100	—

Image 2: LED lamp loads









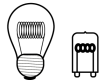
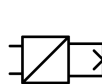

				
230V				
	W	W	VA	W
UNI	20 ... 225	20 ... 210	20 ... 210	20 ... 80
	20 ... 210	—	20 ... 210	—
LED 	20 ... 210	20 ... 210	—	20 ... 80
	20 ... 225	20 ... 225	—	20 ... 150
LED 	20 ... 225	20 ... 225	—	20 ... 150
110V				
	W	W	VA	W
UNI	20 ... 120	20 ... 110	20 ... 110	20 ... 40
	20 ... 110	—	20 ... 110	—
LED 	20 ... 110	20 ... 110	—	20 ... 40
	20 ... 120	20 ... 120	—	20 ... 75
LED 	20 ... 120	20 ... 120	—	20 ... 75

Image 3: conventional lamp loads

i Capacitive-inductive mixed load is not permitted.

Power boosters

See power booster instructions

Connection

Single stranded

0.5 ... 4 mm²

Finely stranded without conductor sleeve

0.5 ... 4 mm²

Finely stranded with conductor sleeve

0.5 ... 2.5 mm²

Connection torque, screw terminals

max. 0.8 Nm

Installation width

72 mm / 4 HP

KNX

KNX medium

TP256

Commissioning mode

S-mode

Rated voltage KNX

DC 21 ... 32 V SELV

Current consumption KNX

6 ... 15 mA

Connection mode KNX

device connection terminal

1.5 Accessories

Compensation module LED

Order no. 2375 00

2 Safety instructions



Electrical devices may only be mounted and connected by electrically skilled persons.

Serious injuries, fire or property damage possible. Please read and follow manual fully.

Danger of electric shock. Always disconnect before carrying out work on the device or load.

Danger of electric shock. Device is not suitable for disconnection from supply voltage because mains potential even is applied on the load when the output is switched off. Always disconnect before carrying out work on the device or load. To do so, switch off all associated circuit breakers.

Risk of destruction of the dimmer and load if the set operating mode and load type do not match. Set the correct dimming principle before connecting or exchanging the load.

Fire hazard. For operation with inductive transformers, each transformer must be fused on the primary side in accordance with the manufacturer's instructions. Only safety transformers according to EN 61558-2-6 may be used.

The device may not be opened or operated outside the technical specifications.

This manual is an integral part of the product, and must remain with the end customer.

3 Mounting and electrical connection



DANGER!

Mortal danger of electric shock.

Disconnect the device. Cover up live parts.

Connecting the device

- Connect bus line with KNX connecting terminal according to their correct polarity.
- Attach the cover cap to the KNX connection as protection against hazardous voltages.

i Delivery state: The outputs can be operated with manual control.

In the "Universal" operating mode, the dimming actuator only calibrates itself again after disconnection of the load and also after commissioning using the ETS.

i Capacitive-inductive mixed load is not permitted.

i For LED leading edge phase control: Connect a maximum of 2 electronic transformers per output.

i Connect 600 Watt LED lamps or compact fluorescent lamps at most per 16 ampere circuit breaker. When connecting transformers, observe the data of the transformer manufacturer.

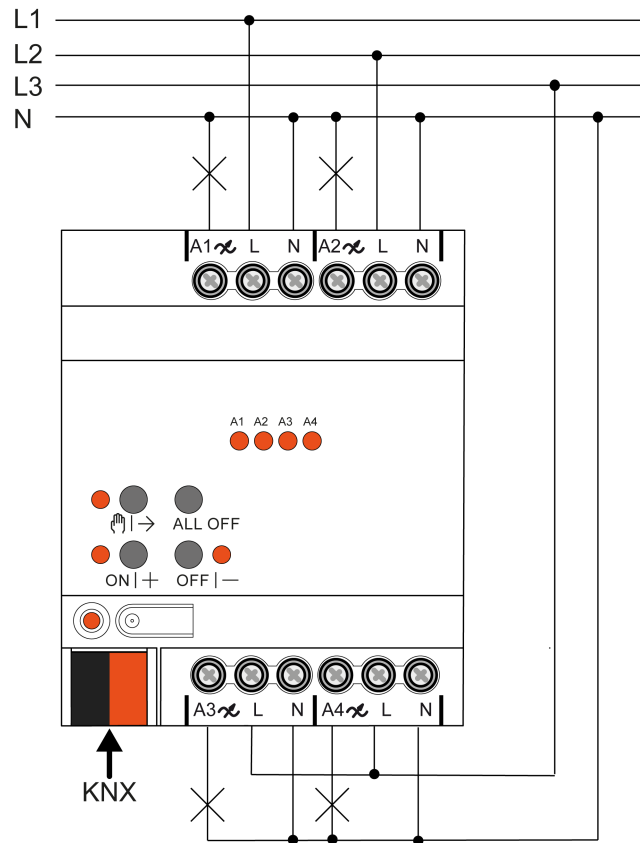

Image 4: Device connection (connection example)

- Connect the lamp loads according to the connection example.

4 Troubleshooting

Connected LED lamps or compact fluorescent lamps switch off in the lowest dimming position or flicker

The set minimum brightness is too low.

Increase minimum brightness.

Connected LED lamps or compact fluorescent lamps flicker

Cause 1: Lamps are not dimmable.

Check manufacturer's instructions.

Exchange lamps for another type.

Cause 2: Dimming principle and lamps do not optimally match.

For HV-LED: Check operation in another dimming principle, reduce connected load as well if necessary.

For LV-LED: Check the lamp operating device and replace as necessary.

With the "Universal" setting: Define the dimming principle manually.

Connected HV-LED lamps or compact fluorescent lamps in the lowest dimming position are too bright; dimming range is too small

Cause 1: The set minimum brightness is too high.

Reduce minimum brightness.

Cause 2: HV-LED trailing edge phase control dimming principle does not optimally match the connected lamps.

Check operation in the "HV-LED leading edge phase control" setting, reduce connected load as well if necessary.

Exchange lamps for another type.

Output has switched off.

Cause 1: overheating protection has tripped.

Disconnect all outputs from the mains, switch-off the corresponding circuit breakers.

HV-LED trailing edge phase control: Reduce the connected load. Exchange lamps for another type.

HV-LED leading edge phase control: Reduce the connected load. Check the operation in the "HV-LED trailing edge phase control" setting. Exchange lamps for another type.

Let device cool down for at least 15 minutes. Check installation situation, ensure cooling, e.g. provide distance from surrounding devices.

Cause 2: Overvoltage protection has triggered.

HV-LED trailing edge phase control: Check the operation in the "HV-LED leading edge phase control" setting, reduce the connected load as well if necessary.

Exchange lamps for another type.

- i** The response of the surge protection can be signalled by sending a short-circuit telegram or can be determined by polling the "short-circuit" communication object.

Cause 3: short-circuit in output circuit

Disconnect all outputs from the mains.

Eliminate short-circuit.

Switch on the mains voltage of the outputs again. Switch the affected output off and on again.

- i** When a short-circuit occurs the affected output switches off. Automatic restart when short-circuit is eliminated within 100 ms (inductive load) or 7 seconds (capacitive or ohmic load). After that lasting switch-off.
- i** When a short-circuit occurs during the calibration process, the load calibrates itself again after the short-circuit is eliminated.

Cause 4: load failure.

Check load, replace light bulb. For inductive transformers, check primary fuse and replace if necessary.

Manual control with button field not possible

Cause 1: Manual control has not been programmed.

Program manual control.

Cause 2: Manual control via bus disabled.

Enable manual control.

None of the outputs can be operated.

Cause 1: All of the outputs are disabled-

Cancel disabling.

Cause 2: Manual mode active.

Deactivate manual mode (switch off continuous manual mode).

Cause 3: Application software missing or faulty.

Check programming and correct.

All outputs off and not possible to switch on

Cause 1: bus voltage failure.

Check bus voltage.

Luminaires flicker or buzz, proper dimming not possible, device buzzes

Cause: wrong dimming principle set

Installation or commissioning error. Disconnect device and luminaire, switch off circuit breaker.

Check installation and correct.

If the wrong dimming principle has been preselected: Set correct dimming principle.

If dimming actuator calibrates itself incorrectly, e.g. with highly inductive mains or long load cables: preselect correct dimming principle with commissioning.

LED lamp is dimly lit when dimmer is switched off

Cause: LED lamp is not optimally suited for this dimmer.

Use a compensation module, see accessories.

Use another type of LED lamp or an LED lamp of another manufacturer.

5 Commissioning

Load physical address and application program

- Press the programming button.
The programming LED lights up.
- Load physical address and application program using the ETS.

Master reset

The master reset restores the basic device settings (physical address 15.15.255, firmware remains in place). The device must then be recommissioned with the ETS. Manual operation is possible.

In secure operation: A master reset deactivates device security. The device can then be recommissioned with the device certificate.

Performing a master reset

Precondition: The safe-state mode is activated.

- Press and hold down the programming button for > 5 s.
The programming LED flashes quickly.

The device performs a master reset, restarts and is ready for operation again after approx. 5 s.

Safe-state mode

The safe-state mode stops the execution of the loaded application program.

-  Only the system software of the device is still functional. ETS diagnosis functions and programming of the device are possible. Manual operation is not possible.

Activating safe-state mode

- Switch off the bus voltage or remove the KNX device connection terminal.
- Wait about 15 s.
- Press and hold down the programming button.
- Switch on the bus voltage or attach the KNX device connection terminal. Release the programming button only after the programming LED starts flashing slowly.

The safe-state mode is activated.

By briefly pressing the programming button again, the programming mode can also be switched on and off in the safe-state mode as usual. If the programming mode is active, the programming LED stops flashing.

Deactivating safe-state mode

- Switch off bus voltage (wait approx. 15 s) or carry out ETS programming.

6 Application programs

ETS search paths:	Illumination / Dimmer / Dimming actuator, 4-gang
Name	Dimming 303A21
Version	2.1
from mask version	for ETS5 from Version 5.7.3 onwards and ETS6 SystemB (07B0)
Summarized description	Multifunctional dimming application with logic functions and manual control. KNX Data Secure capable.
Name	Dimming 303A22
Version	2.2
from mask version	for ETS5 from Version 5.7.3 onwards and ETS6 SystemB (07B0)
Summarized description	Multifunctional dimming application with logic functions and manual control. KNX Data Secure capable. Replaces the application program 2.1

7 Scope of functions

General

- To simplify the configuration, all existing dimming channels can be assigned to the same parameters in the ETS and thus configured identically.
- Up to 8 independent logic functions for the implementation of simple or complex logic operations.
- Actively transmitting feedback or status messages can be delayed globally after bus voltage return or after ETS programming.
- Manual operation of outputs independent of the KNX (for instance, construction site mode) with LED status indicators.

Dimming outputs

- Independent switching and dimming of the dimming outputs.
- Switching feedback mode: Active (transmitting after changes or cyclically to the bus) or passive (object readout) feedback function.
- Reaction in case of bus voltage failure and bus voltage return as well as after ETS programming is adjustable for each output.
- Logic function individual for each output.
- Disabling function can be parameterized for each channel.
- Timing functions (switch-on delay, switch-off delay, staircase lighting timer, also with pre-warning function)
- Incorporation into light moods: up to 16 internal scenes parameterizable per output.
- Input monitoring for cyclical updating of the switching object with safety position.

8 Notes on software

Unloading the application program

The application program can be unloaded with the ETS. In this case the device is without function. Manual operation is no longer possible.

ETS project design and commissioning

For project design and commissioning of the device, ETS5 from Version 5.7.3 onwards or ETS6 is required. Project designing and commissioning of the device using ETS2, ETS3 or ET4 is not possible.

9 Operation and indication

9.1 Button operation and indication functions

Operating elements

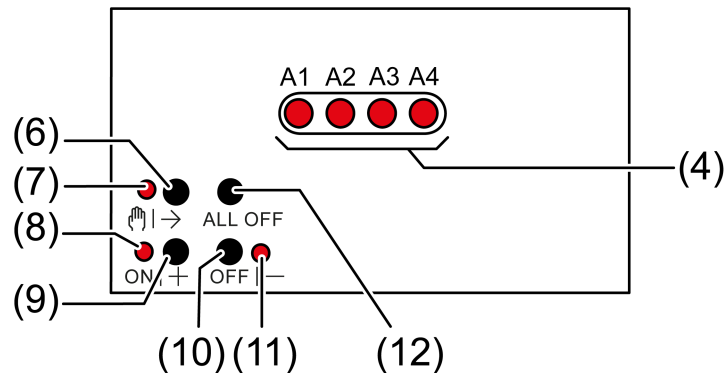

Image 5: Operating elements

- (4) Status LEDs for outputs
 - on: output switched on, 1...100%
 - flashes at 1 Hz: short-circuit or manual mode
 - flashes at 2 Hz: overload, mains voltage failure or firmware update
- (6) Button |→
 - Manual operation
- (7) LED |→
 - on: continuous manual mode
- (8) LED **ON|+**
 - on: selected output on, 1...100%
 - flashes: Firmware update
- (9) Button **ON|+**
 - Switch on/increase brightness
- (10) Button **OFF|–**
 - Switch off/reduce brightness
- (11) LED **OFF|–**
 - on: Selected output off
 - flashes: Firmware update
- (12) Button **ALL OFF**
 - Switching off all outputs

The LEDs (4) optionally indicate the states of the outputs only temporarily (parameter-dependent).

Operating modes

- Bus operation: operation via push-button sensors or other bus devices

- Temporary manual control: manual control locally with keypad, automatic return to bus control
 - Continuous manual mode: Exclusively manual operation on the device
- i** No bus operation is possible in manual mode.
- i** After a bus failure and restoration the device switches to bus operation.

Switching on temporary manual operation mode

Operation using the button field is programmed and not disabled.

- Press button \rightarrow (6) briefly.
LED \rightarrow (7) flashes, LED A1... (4) of the first configured output flashes.
Short-time manual operation is switched on.

i After 5 s without a key-press, the actuator returns automatically to bus operation.

Switching off temporary manual operation mode

The device is in short-term manual mode.

- No button-press for 5 s.
- or -
- Press \rightarrow (6) button briefly as many time as necessary until the actuator leaves the short-time manual mode.
Status LED A1... (4) no longer flash, but rather indicate the output status.
Short-time manual operation is switched off.

When switching off the manual control, the outputs, depending on the programming, switch to the active position, e.g. forced position, logic operation.

Switching on permanent manual operation mode

Operation using the button field is programmed and not disabled.

- Press the \rightarrow (6) button for at least 5 s.
LED \rightarrow (7) lights, LED A1... (4) of the first configured output flashes.
Continuous manual mode is switched on.

Switching off permanent manual operation mode

The device is in continuous manual mode.

- Press the \rightarrow (6) button for at least 5 s.
LED \rightarrow (7) is off.
Continuous manual mode is switched off. Bus operation is switched on.

When switching off the manual control, the outputs, depending on the programming, switch to the active position, e.g. forced position, logic operation.

Operating the outputs

The device is in continuous or short-term manual mode.

- Press the button  (6) briefly as many times as necessary until the desired output is selected.

The LED of the selected output A1... (4) flashes.

The LEDs **ON|+** (8) and **OFF|-** (11) indicate the status.

- Operate output with **ON|+** (9) button or **OFF|-** (10) button.
Short: switch on/off.
Long: dim brighter/darker.
Release: Stop dimming.

The LEDs **ON|+** (8) and **OFF|-** (11) indicate the status.

-  Short-term manual mode: After running through all of the outputs the device exits manual mode after another brief actuation.

Switching off all outputs

The device is in continuous manual mode.

- Press the **ALL OFF** button.
All outputs are shut off.

9.2 ETS configuration

9.2.1 Manual operation

All outputs of the device have electronic manual operation. The button field with 4 function buttons and 3 status LEDs on the front panel of the device can be used for setting the following modes of operation:

- Bus operation: operation via push-button sensors or other bus devices
- Temporary manual operation mode: manual operation locally with button field, automatic return to bus operation
- Permanent manual operation mode: local manual operation with keypad

Manual operation is possible while the device is supplied with power from the bus supply voltage. In the as-delivered state, manual operation is fully enabled. In this un-programmed state, all outputs can be controlled by the manual operation so that fast function checking of the connected loads (e.g. on the construction site) is possible.

After initial commissioning of the actuator via the ETS, manual operation can be enabled or completely disabled.

Disabling manual operation permanently

Manual operation is enabled in the as-delivered state. If the parameter of the same name is deactivated on the "Manual operation" parameter page, no parameters and communication objects for manual operation are available. The outputs can then only be controlled via the bus.

In the case of a temporary status indication, the status LEDs continue to indicate the status of the outputs when the "Manual operation" button is pressed.

Disabling manual operation temporarily

Manual operation can be separately disabled via the bus, even if it is already active. If the disabling function is enabled, then as soon as a disabling telegram is received via the disabling object, the actuator immediately terminates any activated manual operation and locks the function keys on the front panel of the device. The telegram polarity of the disabling object is parameterisable.

Manual operation must be enabled.

- Activate the parameter "Disabling function" on the "Manual operation" parameter page.
The disabling function of manual operation is enabled and the disabling object becomes visible.
- Select the desired telegram polarity in the parameter "Polarity of the disabling object".

- i** If the polarity is "0 = disabled; 1 = enabled", the disabling function is immediately active on return of bus voltage or after an ETS programming operation (object value "OFF"). To activate manual operation in this case, an enable telegram "ON" must first be sent to the disabling object.
- i** After return of bus voltage, a disabled state that was active beforehand is always inactive when the polarity of the disabling object is non-inverted.
- i** When an active manual operation is terminated by a disable, the actuator will also transmit a "Manual operation inactive" status telegram to the bus, if the status messaging function is enabled.

Presetting the behaviour at the beginning and at the end of manual operation

Manual operation distinguishes between the temporary and permanent manual operation modes. The behaviour is different depending on these operating modes, especially at the end of manual operation. It should be noted that the operation via the bus, i.e. control of the outputs by direct operation (switching / dimming / brightness value, scenes, central) or by the disabling or forced position functions is always disabled when the manual control is active. This means that manual operation has the highest priority.

Behaviour at the beginning of manual operation:

The behaviour at the beginning of manual operation does not differ for temporary and permanent manual operation modes. During activation of the manual operation, the brightness statuses of the dimming channels remain unchanged. Flashing feature during disabling function: The flashing of a disabling function is interrupted at the beginning of the manual operation. The brightness adapts itself to the switch-on brightness. The switching status is indicated as "ON". Active forced position functions or disabling functions can be overridden by manual control. These functions are reactivated after deactivation of the manual mode unless they have been cancelled via the bus in the meantime.

Behaviour at the end of manual operation:

The behaviour at the end of manual operation is different for temporary and permanent manual operation modes. The temporary manual operation mode is shut off automatically when the last output has been addressed and when the selection button  is pressed once more. During deactivation of the temporary manual operation mode, the actuator returns to 'normal' bus operation and does not change the brightness states selected by manual control.

The permanent manual operation mode is shut off when the selection button  is pressed for more than 5 seconds. Depending on the parameterization of the actuator in the ETS, the outputs will be set to the state last adjusted in the manual mode or to the state internally tracked (direct operation, forced position, disabling) when the permanent manual mode is switched off. The parameter "End of permanent manual control" defines the corresponding reaction.

- Set the parameter "End of permanent manual control" to "no change".
All telegrams received during an active permanent manual control mode for direct operation (switching, dimming, brightness value, central, scenes) will be rejected. After the end of the permanent manual control mode, the current

brightness state of all the channels remains unchanged. If, however, a forced position or disabling function has been activated via KNX before or during manual operation, the actuator executes these functions of a higher priority again for the channels concerned.

- Set the parameter "End of permanent manual control" to "track outputs".
During active permanent manual operation, all incoming telegrams are tracked internally. At the end of manual operation, the channels are set to the last tracked brightness states. If a forced position or disabling function has been activated via the KNX before or during manual control, the actuator executes these functions of a higher priority again for the channels concerned.

Presetting the status message function for manual operation

An actuator can transmit a status telegram to the KNX via a separate object when the manual operation is activated or deactivated. The status telegram can only be transmitted when the bus voltage is switched on. The polarity of the status telegram can be parameterised.

Manual operation must be enabled.

- Activate the parameter "Status" on the "Manual control" parameter page.
The status messaging function of manual operation is enabled and the status object is visible.
- Specify in the parameter "Status object function and polarity" whether the status telegram is generally a "ON" telegram whenever the manual control mode is activated or only in those cases where the permanent manual mode is activated.
- i** The status object is always "0" when the manual control mode is deactivated.
- i** The "inactive" status is transmitted automatically to the bus after bus voltage return or an ETS programming operation.
- i** When active manual operation is terminated by a disable, the actuator will also transmit a "Manual operation inactive" status telegram to the bus.

Setting disabling of the bus control

Individual dimming channels can be disabled locally by manual operation on the device so that the connected loads can no longer be controlled via the KNX. Such disabling of the bus operation is initiated by operation in permanent manual operation mode and is indicated by rapid flashing of the status LEDs on the front panel of the device. The disabled outputs can then only be activated in permanent manual operation.

Manual operation must be enabled.

- Activate the parameter "Disable bus control of individual outputs" on the parameter page "Manual operation".

The function for disabling the bus control is enabled and can be activated locally. Alternatively, deactivating the parameter prevents disabling of the bus control from being activated in permanent manual operation mode.

- i** The disabling initiated locally has the highest priority. Thus all other functions of the actuator that can be activated via KNX (e.g. forced position or disabling function) are overridden. The bus-disabled output remains in the state last set in permanent manual operation mode.
Depending on the parameterization of the actuator in the ETS, the groups will be set to the state last adjusted in the manual mode or to the state internally tracked (direct operation, forced position, disabling) when the permanent manual mode is reactivated and subsequently shut off.
- i** The disabling function of manual operation does not influence bus-disabled outputs.
- i** A failure of the bus voltage or an ETS programming operation deactivates disabling of the bus control.

9.2.2 Status indication

The status LEDs on the front of the device can indicate the current status of the dimming channels permanently or temporarily.

- Continuous status indication:
The parameter "Indicate status temporarily" on the "Status indication" parameter page is deactivated. In the case of a continuous status indication, the status LEDs always indicate the current status of the outputs.
- Temporary status indication:
The parameter "Indicate status temporarily" on the "Status indication" parameter page is activated. During temporary indication, the status indication is activated by pressing the "Manual operation" button. The display length is set in the ETS.
If manual operation is enabled in the ETS, pressing the "Manual operation" button also activates the temporary or permanent manual operation mode. The status indication always remains active during manual operation. At the end of manual operation mode, the display length of the temporary status indication is restarted. The status LEDs then go out after the configured time has elapsed.
If manual operation is not enabled in the ETS, all status LEDs only show the status of the outputs when the "Manual operation" button is pressed, depending on the duration of the display.

- i** In the as-delivered state, the continuous status indication is preset.

If the parameter "Control via object" is activated, the "Temporary status indication" communication object is available in the ETS. This object is bidirectional and can firstly signal the status of the temporary status indication, and secondly, activate the status display. If a temporary status indication has been activated by pressing the "Manual operation" button, the object transmits the value "ON". If the object receives

a telegram with the value "OFF" or "ON", the status LEDs indicate the status of the outputs according to the display length. Manual operation is not activated in this case.

By linking the "Temporary status indication" objects of several actuators using a common group address, the indication functions of the status LED can be synchronized with one another. It is thus possible to activate the status indications of all actuators in a control cabinet at the same time if manual operation is triggered on one actuator only - e.g. for service or maintenance purposes.

In addition, the "Temporary status display" object could be controlled, for example, by a magnetic contact connected to the KNX, so that the status indications of all actuators are activated by opening the control cabinet door. If the door is closed, the status indications for energy saving remain switched off.

- i During a running display length, the "Temporary status indication" object does not transmit any new telegrams if the "Manual operation" button is pressed again.

9.3 Operation and indication parameters

Manual operation

Manual operation	Checkbox (yes / no)
Manual operation is possible while the device is supplied with power from the bus supply voltage. This parameter defines whether manual operation is to be possible or deactivated permanently.	
End of permanent manual control	no change Output tracking
<p>The behaviour of the actuator at the end of permanent manual operation depends on this parameter. This parameter is only visible if manual operation is enabled.</p> <p>No change: all telegrams received during an active permanent manual control mode for direct operation (switching, dimming, brightness value, scenes) will be rejected. After the end of the permanent manual operation, the current state of all outputs which was most recently active in manual operation remains unchanged. If, however, a forced position or disabling function has been activated via the KNX before or during manual operation, the actuator executes these functions of a higher priority again for the dimming channels concerned.</p> <p>Track outputs: during active permanent manual operation, all incoming telegrams and state changes are tracked internally. At the end of manual operation, the channels are set to the last tracked brightness states. If a forced position or disabling function has been activated via the KNX before or during manual control, the actuator executes these functions of a higher priority again for the channels concerned.</p> <p>This parameter is only visible if manual operation is enabled.</p>	
Bus control of individual outputs can be disabled	Checkbox (yes / no)
<p>Individual outputs can be disabled locally during permanent manual operation, so that the disabled outputs can no longer be controlled via the KNX. Disabling via manual operation is only permitted if this parameter is activated.</p> <p>This parameter is only visible if manual operation is enabled.</p>	

Status indication

Indicating status temporarily	Checkbox (yes / no)
<p>The status LEDs on the front of the device can indicate the current status of the dimming channels permanently or temporarily.</p> <p>Parameter deactivated: Continuous status indication. In this case, the status LEDs always indicate the current status of the outputs.</p> <p>Parameter activated: Temporary status indication. In this case, the status indication is activated by pressing the "Manual operation" button. The display length is set in the ETS. If manual operation is enabled in the ETS, pressing the "Manual operation" button also activates the temporary or permanent manual operation mode. The status indication always remains active during manual operation. At the end of manual operation mode, the display length of the temporary status indication is re-started. The status LEDs then go out after the configured time has elapsed.</p>	
Display length (6...255)	6 ... 10 ... 255
<p>This parameter defines the display length if the temporary status indication is activated.</p>	
Control via object	Checkbox (yes / no)
<p>If the parameter "Control via object" is activated, the "Temporary status indication" communication object is available in the ETS. This object is bidirectional and can firstly signal the status of the temporary status indication, and secondly, activate the status display. If a temporary status indication has been activated by pressing the "Manual operation" button, the object transmits the value "ON". If the object receives a telegram with the value "OFF" or "ON", the status LEDs indicate the status of the outputs according to the display length. Manual operation is not activated in this case.</p>	

9.4 Operation and indication object list

Object no.	Function	Name	Type	DPT	Flag
3	Temporary status indication	Manual operation - Input/Output	1-bit	1,017	C, (R), W, T, A
<p>1-bit object to signal and activate the temporary status indication. This object is bidirectional and can firstly signal the status of the temporary status indication, and secondly, activate the status display. If a temporary status indication has been activated by pressing the "Manual operation" button, the object transmits the value "ON". If the object receives a telegram with the value "OFF" or "ON", the status LEDs indicate the status of the outputs according to the display length. Manual operation is not activated in this case.</p> <p>The object is only visible if the temporary status indication is activated</p>					

10 Dimming operation

10.1 Channel configuration

Channel configuration

The device is used for dimming up to 4 lighting groups.

- i** Connect 600 Watt LED lamps or compact fluorescent lamps at most per 16 ampere circuit breaker. When connecting transformers, observe the data of the transformer manufacturer.
- i** Observe delivery state. Before connecting and switching on, program the dimming actuator to the changed output configuration.

To simplify the configuration, all existing dimming channels can be assigned to the same parameters in the ETS and thus configured identically. The parameter "Channel parameters" on the parameter page "General" specifies whether every dimming channel of the device can be configured individually or whether all channels should be configured by the same parameters.

In the "all channels equal" setting, the number of parameters in the ETS is reduced. The visible parameters are then used on all channels automatically. Only the communication objects can then be configured separately for the channels. This setting should be selected, for example, if all channels behave identically and should only be activated by different group addresses (e.g. in office blocks or in hotel rooms).

- i** The parameter and object configurations of the individual outputs depend on the parameters on the "General" page and are readjusted by the ETS when the channel definition is changed. Consequently, parameter settings or group address assignments to objects can be lost. For this reason, the channel definition should be reset when beginning the parameterization of the actuator.

10.1.1 Channel configuration parameters

General -> Channel configuration

Number of dimming channels	4 dimming channels (O1) + (O2) + (O3) + (O4)
This parameter cannot be changed.	
Channel parameters	each channel individual all channels equal
<p>To simplify the configuration, all existing dimming channels can be assigned to the same parameters in the ETS and thus configured identically. This parameter stipulates whether every dimming channel of the device can be configured individually or whether all channels should be configured by the same parameters.</p> <p>In the "all channels equal" setting, the number of parameters in the ETS is reduced. The visible parameters are then used on all channels automatically. Only the communication objects can then be configured separately for the channels. This setting should be selected, for example, if all channels behave identically and should only be activated by different group addresses (e.g. in office blocks or in hotel rooms). In the "each channel individual" setting, all dimming channels of the device can be configured autonomously.</p>	

10.1.2 Channel configuration object list

Object no.	Function	Name	Type	DPT	Flag
31, 51, 71, 91	Switching	Dimming channel ... (...) - Input	1-bit	1,001	C, -, W, -, U
1-bit object for switching the dimming channel on or off ("1" = switch on; "0" = switch off).					
Object no.	Function	Name	Type	DPT	Flag
32, 52, 72, 92	Switching feedback	Dimming channel ... (...) - Output	1-bit	1,001	C, R, -, T, A
1-bit object for feedback signalling of the switching state ("1" = on / "0" = off) to the bus.					
Object no.	Function	Name	Type	DPT	Flag
34, 54, 74, 94	Dimming	Dimming channel ... (...) - Input	4-bit	3,007	C, -, W, -, U
4-bit object for relative dimming of a dimming channel.					
Object no.	Function	Name	Type	DPT	Flag
35, 55, 75, 95	brightness value	Dimming channel ... (...) - Input	1 bytes	5,001	C, -, W, -, U
1-byte object for predefining an absolute dimming value (brightness value 0...255) from the bus.					

10.2 Name of the dimming channel

Optional names can be assigned for each dimming output. The names should clarify the use of the output (e.g. "living room wall lamp", "bathroom ceiling lamp"). The names are only used in the ETS in the text of the parameter pages and communication objects.

10.2.1 Name of the dimming channel parameters

Dimming channel ... -> DO... - General

Name of the dimming channel	Free text
<p>The text entered in this parameter is applied to the name of the communication objects and is used to label the dimming output in the ETS parameter window (e.g. "living room wall lamp", "bathroom ceiling lamp").</p> <p>The text is not programmed in the device.</p>	

10.3 Defining load type



CAUTION!

Risk of destruction if the preset dimming principle and connected load do not match. The dimmer and load may be destroyed.
Before changing the dimming principle, observe load type.
Before changing the load type, make sure that the dimming principle is correct.
Before changing the load type, disconnect the load circuit concerned. Check parameter settings and adjust if necessary.



CAUTION!

Danger of destruction from mixed loads. The dimmer and load may be destroyed.
Do not connect capacitive loads, e.g. electronic transformers, and inductive loads, e.g. inductive transformers, together on the same dimmer output.
Do not connect inductive transformers together with HV LED lamps or compact fluorescent lamps on the same dimmer output.

The device works according to the leading edge phase control or trailing edge phase control dimming principle and makes switching and dimming of incandescent lamps, HV halogen lamps and LV halogen lamps, compact fluorescent lamps as well as HV LEDs and LV LEDs possible by means of conventional transformers and Tronic transformers. The characteristic of the connected load can automatically be measured separately for each dimming channel and the appropriate dimming procedure can be set. Alternatively, the dimming procedure can be predefined by a parameter in the ETS without calibration taking place. This procedure is necessary for loads that do not enable automatic calibration.

- i** When selecting the appropriate dimming principle, the specifications of the lamp manufacturer and/or transformer manufacturer should generally be observed.
 - Set the parameter to "universal (with calibration procedure)".
The dimming channel calibrates itself universally to the connected load type. After programming in the ETS, after bus voltage return, or after switching on the mains voltage supply of a load output, the actuator calibrates itself automatically to the connected load. The calibration procedure becomes noticeable during ohmic loads by a brief flicker and lasts up to 10 seconds depending on the network conditions.
- i** This setting must not be selected for loads that do not enable automatic calibration. In this case, a suitable dimming principle must be preselected (see following settings).
 - Set the parameter to "electronic transformer (capacitive / phase cut-off)".

The dimming channel is preset to trailing edge phase control principle. There is no automatic calibration of the load type. Ohmic loads, electronic transformers or LV-LEDs (via Tronic transformers) can be connected to the output.

- Set the parameter to "conventional transformer (inductive/leading edge phase control)".

The dimming channel is preset to leading edge phase control principle. There is no automatic calibration of the load type. Conventional transformers or LV-LEDs (via conv. transformers) can be connected to the output.

- Set the parameter to "LED (Phase cut-off)". The dimming channel is preset to an optimized trailing edge phase control principle.

There is no automatic calibration of the load type. HV LED or compact fluorescent lamps optimized for this dimming principle can be connected to the output.

- Set the parameter to "LED (Phase cut-on)".

The dimming channel is preset to an optimized leading edge phase control principle. There is no automatic calibration of the load type. HV LED or compact fluorescent lamps optimized for this dimming principle can be connected to the output. Conventional transformers cannot be connected to the output.

i In the as-delivered state of the device, the dimming principle is set to "universal" for all outputs.

i When changing a load type on an output, the dimming principle must also be changed if necessary!

Recommendation for the configuration of the dimming principle with HV-LED lamps:

It is recommended to set the "Type of connected load" in the ETS to "universal" (this dimming principle also corresponds to the as-delivered state of the dimming actuator). If automatic calibration of the load does not work or produces insufficient dimming results, it is recommended to operate HV LED lamps preferably in the load type "LED trailing edge phase control", regardless of the manufacturer's specification. The advantage of this setting lies in the fact that a dimming output can provide the maximum LED nominal load (see technical data). This is often not possible in leading edge phase control principle. Only configure the type of load in the ETS to "LED leading edge phase control" if the operation of the connected LED lamps in the trailing edge phase control principle is not satisfactory (e.g. dimming range is too small).

Protection functions (over-voltage switch-off) ensure that the device is not destroyed if the connected LED lamps are controlled in a dimming principle that the manufacturer has not designed them for.

Problem resolution with HV-LED lamps:

Possible problems during operation of HV LED lamps and their remedial measures are demonstrated in the following.

Parameter setting "LED trailing edge phase control" ->

Problems:

- Dimming range too small
- Minimum brightness too high
- Lamps flicker
- Output switches off due to overvoltage

Remedy: Check operation in the leading edge phase control, reduce connected load as well if necessary, exchange lamps for another type.

Parameter setting "LED leading edge phase control" ->

Problems:

- Lamps flicker
- Dimmer actuator overheats (output switches off due to overtemperature)
- Dimmer actuator hums

Remedy: Reduce connected load, check operation in the trailing edge phase control, exchange lamps for another type.

10.3.1 Load type parameter

Dimming channel ... -> DO... - General

Load type	universal (with automatic calibration procedure) electr. transformer (capacitive / trailing edge phase control) conv. transformer (inductive / leading edge phase control) LED (trailing edge phase control) LED (leading edge phase control)
<p>The dimming principle of the dimming channel is specified here.</p> <p>universal (with automatic calibration procedure): The dimming channel calibrates itself universally to the connected load type. After programming with the ETS, after bus voltage return (without mains voltage) or after switching on the mains voltage supply of a load output, the actuator calibrates itself automatically to the connected load. The calibration procedure becomes noticeable during ohmic loads by a brief flicker and lasts up to 10 seconds depending on the network conditions.</p> <p>Electronic transformer (capacitive/trailing edge phase control): The dimming channel is preset to the trailing edge phase control principle. There is no automatic calibration of the load type. Ohmic loads or electronic transformers can be connected to the output.</p> <p>Conventional transformer (inductive/leading edge phase control): The dimming channel is preset to the leading edge phase control principle. There is no automatic calibration of the load type. Conventional transformers can be connected to the output.</p> <p>LED (trailing edge phase control): The dimming channel is preset to an optimized trailing edge phase control principle. There is no automatic calibration of the load type. HV LED or compact fluorescent lamps optimized for this dimming principle can be connected to the output.</p> <p>LED (leading edge phase control): The dimming channel is preset to an optimized leading edge phase control principle. There is no automatic calibration of the load type. HV LED or compact fluorescent lamps optimized for this dimming principle can be connected to the output.</p>	

10.4 Operation with universal power booster (OLD)

To increase the connected load, power boosters can be connected to the device.

- i** Power extension possible by means of our own power boosters.
- i** Choose power boosters that are suitable for the dimmer and load! For additional information, please always refer to the instructions for the power extensions in question.
- i** Visible brightness differences between the lighting on a dimmer actuator output without power booster and a dimming actuator with power booster are possible.
- i** When using conventional power boosters for leading edge phase control or trailing edge phase control principle (NV or TRONIC power boosters) it is not normally necessary to adapt the output signal of the dimmer actuator.
- i** In the case of parallel wiring of dimming outputs, it is not permitted to connect additional power extensions to the load outputs concerned!
- i** Older universal power boosters (order no. 1035 00), which are not designed for operation with LEDs, supply themselves with energy directly via components of the dimming actuator's output signal (no neutral conductor connection available). To ensure failure-free operation, the dimmer actuator output signal must be adapted in such a way that a certain amount of residual phase angle still remains (residual cut-on or off) for the highest dimming position. This residual phase angle must be large enough to enable universal power boosters to supply themselves with energy. When connecting the current Universal LED power booster DRA, order. no. 2383 00, this adjustment is not necessary.
- Deactivate the parameter "Operation with universal power booster (OLD)".
No universal power booster (order no. 1035 00) is connected to the dimming channel. In the highest dimming position (100 % brightness value), the smallest possible residual phase angle is set on the dimmer output. As a result, the connected lighting is set to the maximum lighting level technically possible.
- Activate the parameter "Operation with universal power booster (OLD)".
At least one universal power booster (order no. 1035 00) is connected to the dimming channel. In the highest dimming position (100 % brightness value), a residual phase angle necessary for universal power boosters is set on the dimmer output. The output signal cut-on or cut-off in this way corresponds to a resulting brightness of approx. 90 % compared to an identically constructed dimming actuator without a power booster. The dimming actuator rescales the adjustable brightness range automatically for the corresponding channel so that a presetting and feedback within a range of 0...100% is still possible.

10.4.1 Parameter operation with universal power booster (OLD)

Dimming channel ... -> DO... - General

Operation with universal power booster (OLD)	Checkbox (yes / no)
<p>If the output power is increased by means of older universal power boosters (order no. 1035 00), the corresponding channel configuration of the dimming actuator must be adapted here. The dimming actuator adapts the output signal automatically for using universal power boosters based on the setting of this parameter. When connecting the current Universal LED power booster DRA, order. no. 2383 00, this adjustment is not necessary.</p>	

10.5 Dimming characteristic

The human eye is adapted to natural daylight. As a result, it works in a very wide range of brightness from twilight in the early morning and late evening to bright daylight at noon. In the lower brightness area the eye is clearly more sensitive than in the upper area.

When dimming simple lamps, the electrical power is uniformly converted into a luminous flux that is emitted into the surrounding room. This luminous flux results in illuminance that can be measured with a luxmeter. If the lamp emits 50% of its maximum luminous flux, it already appears as intense brightness to the eye. When the luminous flux of the lamp rises to 75%, illuminance increases by the same amount. However, the eye perceives this change much weaker.

When different current lamp types are dimmed, luminous flux and subjective perceptions of brightness can vary considerably. For this reason, the dimming actuator offers several options for adjusting the dimming characteristics as required.

- If the lighting is regularly controlled via percentage presetting of the dimming value, the suitability of the dimming characteristic in the value range should be checked as a priority.
- If the lighting is dimmed manually via the 4-bit object, the dimming characteristic can be adjusted in the time range.

Dimming characteristic curve in the value range

Six characteristic curves are available for adapting to different luminaires, which the dimming actuator can use to convert the percentage input value from the KNX (DPT 5.001) to the output value of the dimming channel. The following table shows the differences in the characteristic curves.

KNX value	KNX value [%]	logarithmic function [%] (1)	root function [%] (2)	linear function [%] (3)	quadratic function [%] (4)	cubic function [%] (5)	exponential function [%] (6)
0	0	0	0	0	0	0	0
1	0.4	0	6	0.4	0	0	0
10	4	42	20	4	0	0	0
25	10	58	31	10	1	0	0
50	20	71	44	20	3	1	0
80	32	79	56	32	10	3	0
100	40	83	63	40	15	6	0
125	50	87	70	50	24	12	0
150	60	90	77	60	35	20	1
175	70	93	83	70	47	32	2.4
200	80	96	88	80	62	48	8
225	90	98	94	90	78	69	25

KNX value	KNX value [%]	logarithmic function [%] (1)	root function [%] (2)	linear function [%] (3)	quadratic function [%] (4)	cubic function [%] (5)	exponential function [%] (6)
255	100	100	100	100	100	100	100

Table 1: Dimming characteristics in the value range

The connected luminaires convert the dimmed output voltage into a luminous flux that is emitted into the room. This luminous flux is different for each type of lamp. The subjective brightness perception of the human eye differs from the illuminance that can be measured.

The following diagrams present a comparison for a lamp type of the measured illuminance and the brightness perceived for the dimming characteristics that can be set in the ETS. Because the properties of different lamp types deviate from one another, the most suitable dimming characteristic must be determined locally if necessary. If an existing lamp is replaced by a lamp of a different type, it may be useful to change the dimming characteristic.

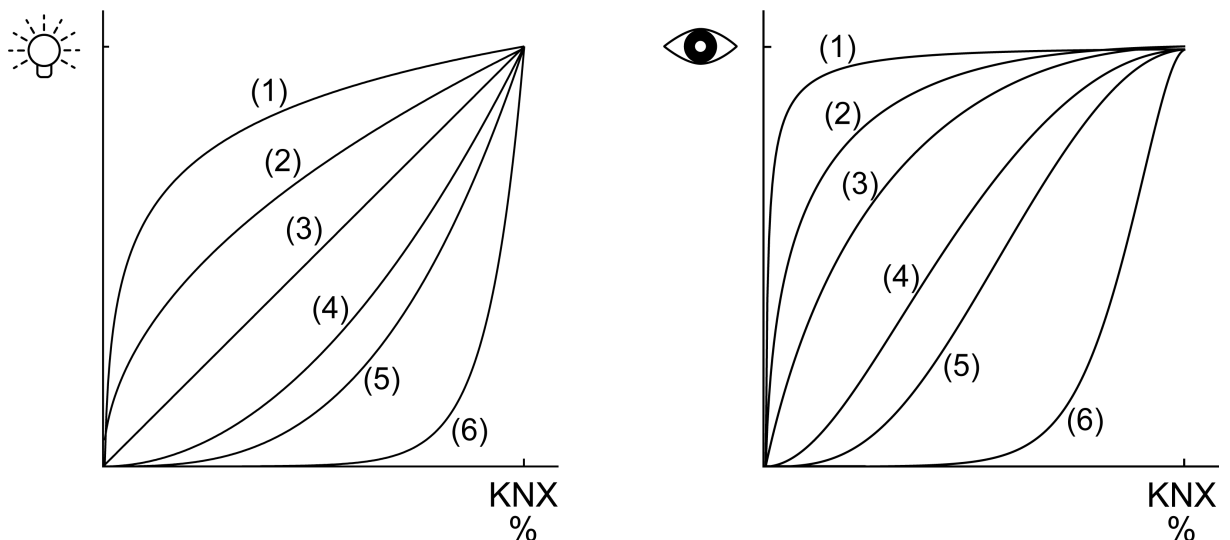

Image 6: Dimming characteristics in the value range

Setting the dimming characteristic in the value range

In the as-delivered state, the linear dimming characteristic is set in the value range. If the dimming behaviour is not satisfactory, particularly in the lower dimming range, the dimming behaviour may be improved by selecting a different dimming characteristic. The adjustment of the dimming characteristic is related to the adjustment of the lower brightness limit and the maximum brightness.

The 1-byte brightness value communication object is connected to a group address. The maximum brightness is set to 100%. When a brightness value is received, the value is jumped to.

- Check/set the lower brightness limit.
- Gradually increase the brightness value and evaluate the brightness change.
- If the brightness change in the lower range is too strong, select a flatter characteristic curve.

- If the brightness change in the lower range is too weak, select a steeper characteristic curve.
- For maximum brightness, select the brightness value from which no change is visible in the upper range.

The dimming characteristic is set in the value range.

i If dimming operation cannot be set properly with the dimming characteristics in the value range, check the load type or replace the lamp with another type.

Dimming characteristic curve in the time range

In the case of the dimming actuator, the technically dimmable brightness range (basic brightness ... 100 %) is subdivided into 255 dimming increments (8-bit brightness value: 1...255 / 0 = switched off). In the as-delivered state of the actuator, the dimming increment times, i.e. the dimming times between 2 of 255 dimming increments, are set to the identical length. This results in a linear characteristic curve over the entire brightness range.

The dimmable brightness range is limited at the upper limit by the maximum brightness configured in the ETS. The lower brightness range is either defined by the basic brightness ("level 1", "level 2" to "level 8" -> "1%") or alternatively, by the minimum brightness. The dimming characteristics shown in the following diagrams distinguish these configurations and illustrate the resulting real dimming time of a dimming procedure.

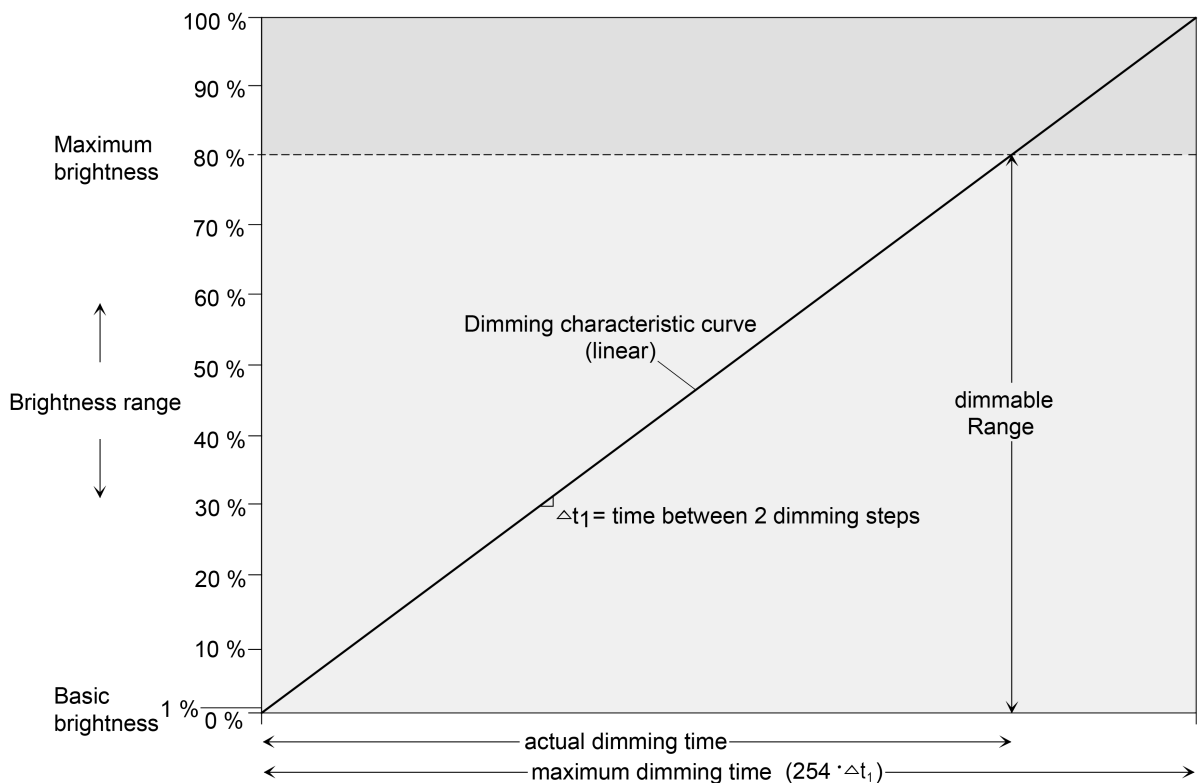

Image 7: Linear dimming characteristic as an example with basic brightness and maximum brightness

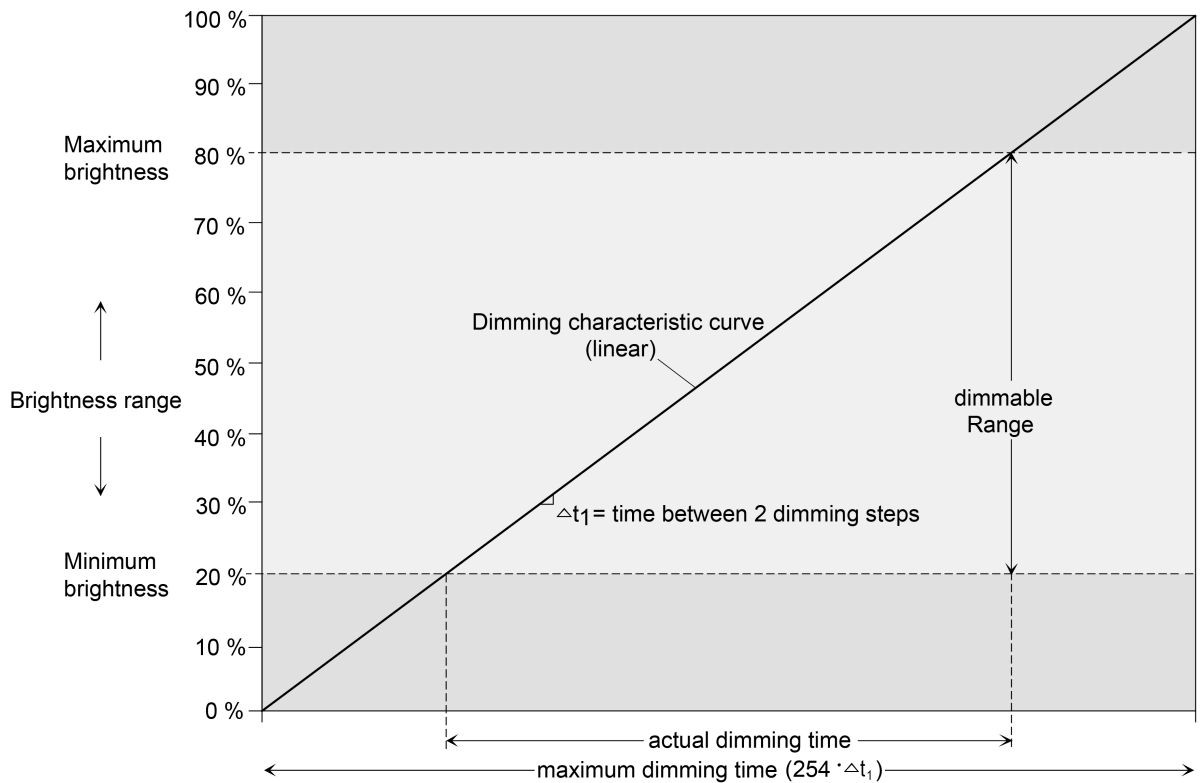

Image 8: Linear characteristic dimming curve as an example with minimum brightness > 0 % and maximum brightness

In some practical applications, a linear dimming characteristic is not optimal. Hence, the actuator in the ETS alternatively permits a user-defined adjustment of the dimming progress. In this way, for example, brightness changes can be adjusted to the brightness sensitivity of the human eye when dimming by subdividing the brightness range in up to 5 sections with different dimming increment times.

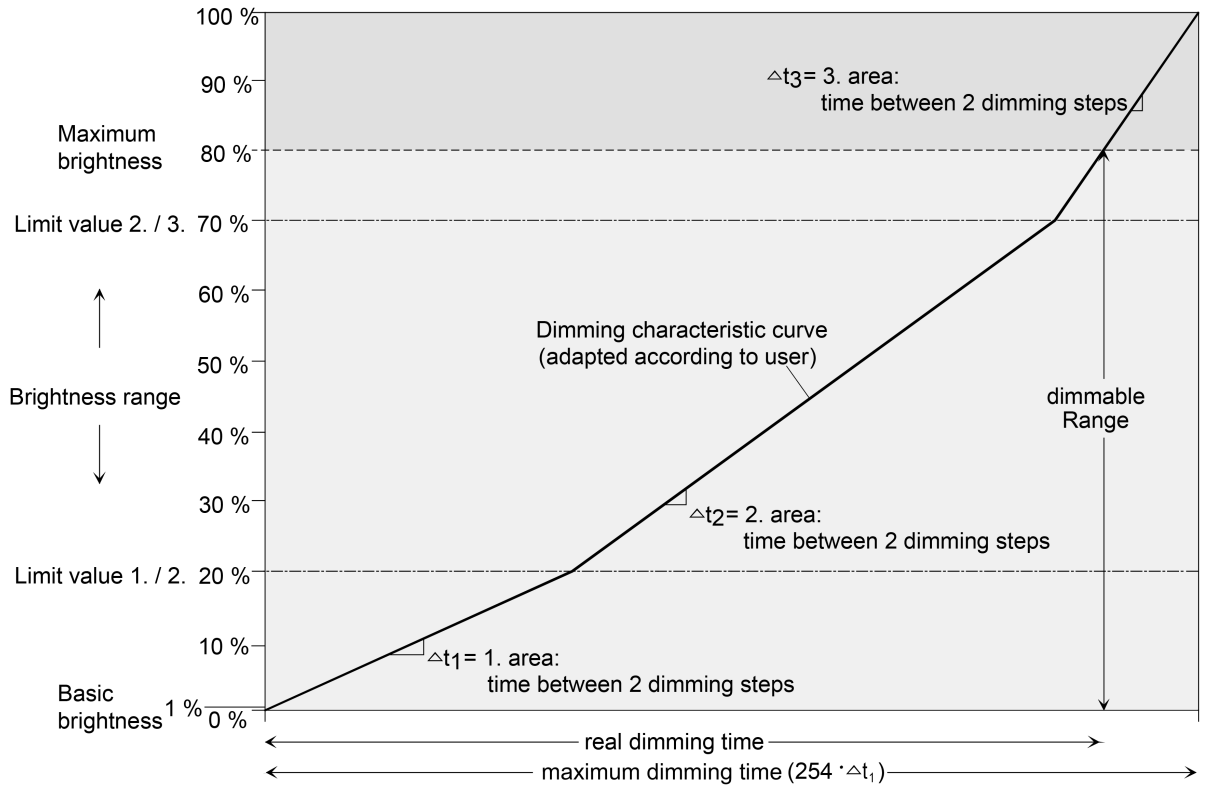

Image 9: User-defined dimming characteristic as an example with basic brightness and maximum brightness

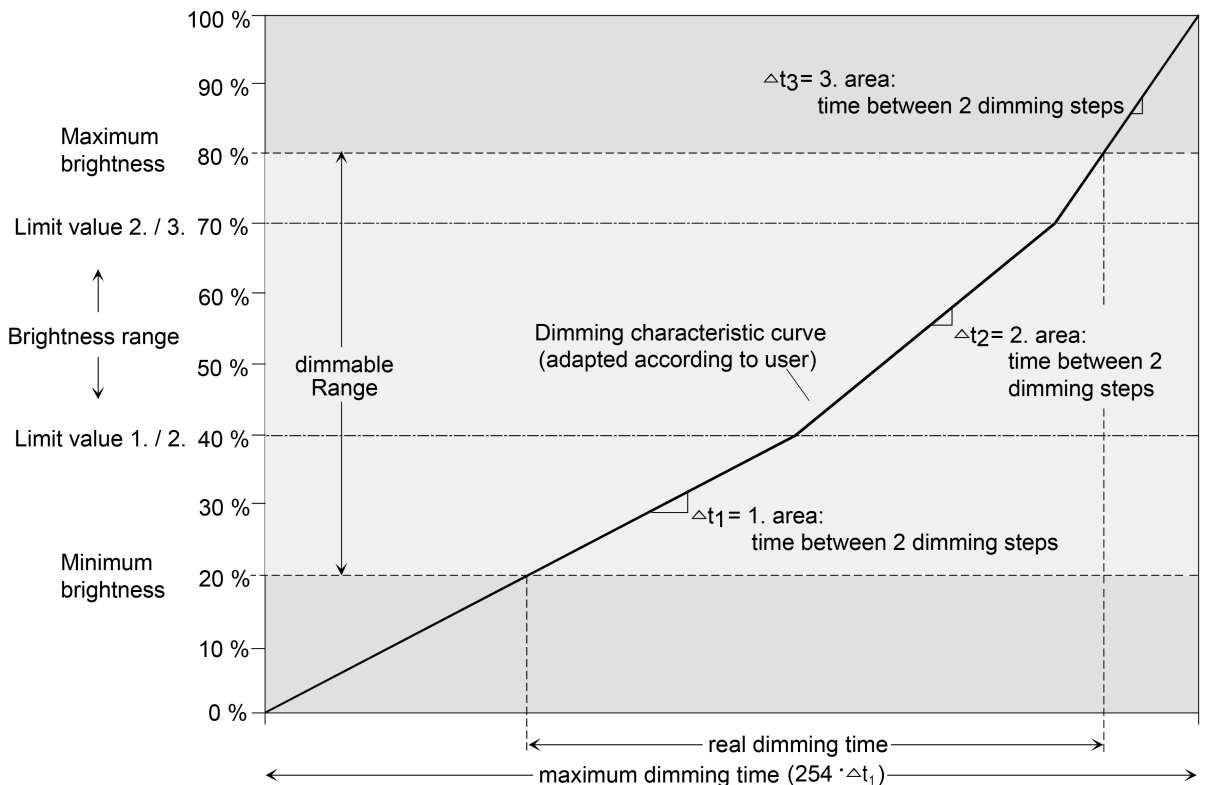

Image 10: User-defined dimming characteristic as an example with minimum brightness and

Setting the dimming characteristic in the time range

- Set the parameter "Characteristic curve in the time range" on the parameter page "DAX - dimming characteristic" (x = number of the dimming channel 1...4) to "Linear function".

A linear dimming characteristic curve is set. A time between two dimming increments can also be configured for the entire brightness range in the ETS.

- Set the parameter "Characteristic curve in the time range" on the parameter page "DAX - dimming characteristic" (x = number of the dimming channel 1...4) to "User-defined (y ranges)" (y = 2...5).

A user-defined dimmer characteristic curve is set. Up to 4 limiting values and 5 times between two dimming increments can be defined for the definition of the brightness sections.

The dimming increment speed is identical for a relative dimming procedure or for the dimming of an absolute brightness value (not fading) and can be set in the ETS separately for each dimming channel in the characteristic parameters.

The parameter "Characteristic curve" in the time range is set to "Linear".

- Set the parameter "Time between two dimming increments" on the parameter page "DAX - dimming characteristic" (x = number of the dimming channel 1...4) to the necessary dimming increment time.

During every relative or absolute dimming procedure, the entire brightness range is dimmed with the configured dimming increment speed.

The parameter "characteristic curve" is set to "user-defined".

- First define the brightness limit values. For this purpose, set the parameter "until brightness limiting value" of the various ranges on the parameter page "DAX - dimming characteristic" (x = number of the dimming channel 1...4) to the necessary section limits.

When configuring the limiting values, care must be taken to ensure that the values do not exceed the maximum brightness or fall below the configured minimum brightness.

The dimmable brightness range is divided into up to 5 sections. In the following, the dimming increment speeds for these three areas can be set separately.

- Set the parameter "Time between two dimming increments" on the parameter page "DAX - dimming characteristic" (x = number of the dimming channel 1...4) to the necessary dimming increment time for each section.

The dimming characteristic is defined ready. Each of the up to 5 sections is dimmed at the specified dimming increment speed.

10.5.1 Parameter Dimming characteristic

Dimming channel ... -> DO... - General -> Dimming characteristic

Characteristic curve in the time range	linear function User-defined (2 ranges) User-defined (3 ranges) User-defined (4 ranges) User-defined (5 ranges)
--	--

The dimming characteristic curve of the dimming channel in time domain can be set here. The lamp used can thus be adapted to the brightness sensitivity of the human eye.

Linear function: The brightness curve of basic brightness (decimal brightness value "1") up to 100% (decimal brightness value "255") is linear.

User-defined (... ranges): The brightness curve between basic brightness/minimum brightness and maximum brightness can be adapted individually. For this purpose, the brightness range is subdivided in up to 5 sections. Each section can be configured with an independent dimming speed.

Range ...	1 ... 25 ... 255 ms
Time between two dimming increments	

At this point, the dimming step speed (time between two dimming values) of the respective partial range is set.

With a linear characteristic curve there is only range 1.

Range ...	Basic brightness
until brightness limiting value	5 %
	10 %
	...
	100 %

The brightness limiting value is configured here. This limiting value defines the boundary between the first and second section.

With a linear characteristic curve, the limit value is fixed at 100 %.

Characteristic curve in the value range	linear function exponential function cubic function quadratic function root function logarithmic function
<p>Setting the characteristic curve in the value range allows the 256 dimming steps possible on KNX to be adapted to the perception of the human eye. If this parameter is changed, the curve of the characteristic curve is shown in the diagram below.</p> <p>The selection of the characteristic curve depends on the connected lamp.</p>	

10.6 Brightness range

The brightness range, adjustable by switching or dimming procedures, can be limited by defining a lower and upper brightness value. The lower brightness value is defined by the basic brightness. The upper brightness value is always characterised by the maximum brightness. The maximum brightness adjustable in the ETS is never exceeded under any circumstances in the switched-on operating state of a dimming channel. Neither when switching on nor when dimming. The maximum brightness value can be reduced for energy saving reasons, for example. In combination with some power boosters, it may also be necessary to reduce the maximum brightness (please observe the documentation of the power boosters and notes in the chapter "Mounting and electrical connection" in this documentation!). Furthermore, the brightness value, which should be set whenever switching on via the "switching" or "central switching" object or by manual operation on the dimming channel, can be predefined. This switch-on brightness must always be between the upper and lower brightness limit value of the dimming range. The adjustable characteristics of the lower brightness value in the ETS differ as follows...

- The lower brightness value is defined by the basic brightness (see figure 11). The "Basic brightness" parameter on the parameter page "DAX – General" (x = number of the dimming channel 1...4) sets the lower brightness threshold by adapting to the luminaire.

The basic brightness can be set to one of 8 step values and is a gauge for the minimum adjustable residual phase angle of the output signal in relation to the decimal brightness values "1", "2" and "3" (percentage: ~0.4 ... 1 %). The basic brightness can be undershot only by switching off. The configurable basic brightness enables the dimming signal to be adjusted in the smallest possible dimming position of the luminaire used. The basic brightness should be set to a step value at which the lamp at the smallest brightness value will still light up at an adequate level of brightness so that it is detected as switched on. A recommendation for incandescent lamps and halogen lamps is given in the ETS as an adjustment aid.

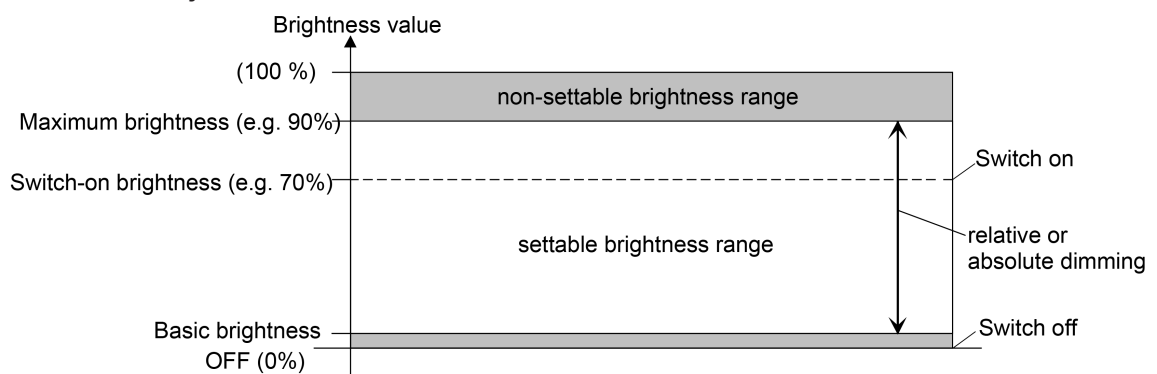

Image 11: Example of a brightness range with basic brightness

Adjusting basic brightness

The basic brightness can be set separately for each dimming channel.

The parameter "Lower brightness limit" is set to "as basic brightness".

- Set the "Basic brightness" parameter to the required level value.
The set level value is a gauge for the smallest adjustable residual phase angle of the output signal and therefore cannot be undershot in any switched-on operating state of the dimming channel.
- i** The parameter should be set in such a way that the lamp will still light up at the lowest dimmer setting.
- i** When operating a universal power booster on the dimmer output (see parameter "Operation with universal power booster (OLD)", "Level 1" can be set, but has no effect. If the parameter should be set to level 1 in this case, the device executes level 2 as basic brightness.

Setting the maximum brightness

The maximum brightness can be set separately for each dimming channel.

- Set the "maximum brightness" parameter on the parameter page "DAx - General" (x = number of dimming channel 1...4) to the required brightness value.
The set brightness is not undershot in any switched-on operating state of the dimming channel.
- i** The ETS does not check all configured brightness values of a channel during the editing of the maximum brightness (e.g. switch-on brightness, scene values)! If values that are greater than the configured maximum brightness are predefined by the ETS configuration, the actuator sets the maximum brightness as brightness value later during operation. The same holds true if the actuator receives values via the brightness object during operation, which exceed the maximum brightness.
- i** When extending the power of an output of a dimming channel from our company by means of universal power boosters, the maximum brightness (ETS parameter) must be reduced to 90 % at most!

10.6.1 Brightness range parameter

Dimming channel ... -> DO... - General -> Brightness range

Lower brightness limit	as basic brightness
<p>The brightness range, adjustable by switching or dimming procedures, can be limited by defining a lower and upper brightness value.</p> <p>The lower brightness value is defined by the basic brightness. The upper brightness value is always characterised by the maximum brightness. The maximum brightness adjustable in the ETS is never exceeded under any circumstances in the switched-on operating state of a dimming channel. Neither when switching on nor when dimming.</p>	
Basic brightness	Level 1 Level 2 Level 3 ... Level 8
<p>The step value set here is a gauge for the minimum adjustable residual phase angle of the output signal and is set to the decimal brightness values "1", "2" and "3".</p> <p>The step value cannot be undershot in any switched-on operating state of the dimming channel.</p> <p>This parameter is only visible if the "Lower brightness limit" is set to "Basic brightness".</p>	
Maximum brightness	1 % 5 % 10 % ... 100 %
<p>The brightness set here is not undershot in any switched-on operating state.</p>	

10.7 Switching / dimming behaviour

Switch-on brightness

The switch-on brightness can be set separately for each dimming channel.

- Set the "switch-on brightness" parameter on the parameter page "DAx - General" (x = number of dimming channel 1...4) to the required brightness value.
The set brightness is set after receipt of an ON telegram via the "Switching" communication object or by switching on by the manual operation on the dimming channel. Furthermore, the configured switch-on brightness is set with the "activated" polarity after receipt of a central telegram.
- Alternatively, set the parameter "Switch-on brightness" to "Memory value (brightness before switching off last time)".
When switching on, the active and internally saved brightness value prior to switching off last time is set (via the "switching" or "central switching" object). After programming with the ETS, the value is predefined to maximum brightness. A bus voltage failure, however, does not delete the memory value.
- i** If the configured switch-on brightness is greater than the configured maximum brightness, the actuator sets the maximum brightness as the new brightness value for the dimming channel concerned when switching on (minimum brightness < switch-on brightness < maximum brightness).
- i** A memory value is also then saved internally by a switch-off telegram if the bus-controlled switch-off is overridden, for example, by a disable or forced position function or by a manual operation. In this case, the internally tracked brightness value is saved as memory value.
- i** If no soft ON function is activated, the brightness value is jumped to when switching on. Once a soft ON function is activated, the switch-on brightness is dimmed according to the dimming speed for the soft ON function.

Behaviour when receiving a brightness value

The dimming behaviour for the absolute dimming can be set separately in the ETS for each dimming channel via the "Brightness value" object.

- Set the parameter "On receipt of a brightness value" on the parameter page "DAx - General" (x = number of dimming channel 1...4) to "dim".
Once a new brightness value is received, it is set by means of the configured dimming increment time based on the predefined dimming characteristic.
- Set the parameter "dimming behaviour after receipt of a brightness value" to "jump to".
As soon as a new brightness value is received it will be instantly jumped to.
- Set the parameter "dimming behaviour after receipt of a brightness value" to "fading". In addition, on the parameter "Time for brightness value via fading", define the necessary fading time for dimming the scene brightness value.

Newly received brightness values will be dimmed. The dim fading is activated. The fading time defines the duration of the dimming procedure required to reach the new brightness value. The brightness value of a dimming channel on which the dimming starts and the configured dimming characteristic have no significance. The dimming procedure thus always requires the exact pre-defined time when specifying a new brightness value.

- i** Brightness values can also be set by a disabling or forced position function. Absolute dimming can also be activated, even in case of bus voltage failure, after bus or mains voltage return or after programming with the ETS, by specifying brightness values. In the case of these absolute dimming functions, the brightness values are always instantly jumped to. During a scene recall, the dimming behaviour can be configured separately.

Dimming up in the switched-off state

A relative dimming process can be triggered by the 4-bit "dimming" communication object available separately in each dimming channel or by a long button-press of the manual operation. The data format of the "dimming" object complies with the KNX standard DPT "3.007", which means that the dimming direction and relative dimming increments can be predefined in the dimming telegram or dimming procedures can also be stopped. A relative dimming process is executed via the object until the configured basic minimum or maximum brightness of the dimming channel is set, the dimming value reaches the dimming increment predefined in the telegram or a stop telegram is received. A relative dimming process allows a brightness value to be changed constantly and always starts from the brightness that is set stationary or dynamically at the time of the incoming dimming telegram.

A relative dimming telegram can also switch on a dimming channel if this is in the "OFF" state. In some applications, it may be necessary, however, for a switched off dimming channel to remain off until a relative dimming telegram is received. This is interesting when using light scenes, for instance: Several dimming channels are set to a defined brightness value via a light scene. Other channels are switched off by the scene. Only the brightness of channels not switched off by the scene recall should be changed by dimming up afterwards. Here, it is necessary for dimming channels not to react to a relative dimming operation and thus not to switch on.

The parameter "With relative dimming up in the switched-off state" defines whether or not a dimming channel in the "OFF" state reacts to a relative dimming telegram.

- Set the parameter to "Switch on channel".
The dimming channel always reacts to a relative dimming telegram and executes a dimming process. In the "OFF" state, the channel switches on with a "dim up" telegram.
- Set the parameter to "No reaction".
The dimming channel only reacts to a relative dimming telegram when it is switched on. In the "OFF" state, the channel ignores a "dim up" telegram.

- i** In manual operation on the device, it is possible in the "OFF" state to always switch on and increase brightness by a long press of the button. The parameter "With relative dimming up in the switched-off state" thus has no effect on manual operation.

10.7.1 Switching/dimming behaviour parameters

Dimming channel ... -> DO... - General -> Switching/dimming behaviour

Switch-on brightness	Basic brightness 5% 10% ... 100% Memory value (brightness before last switch-off)
<p>This parameter specifies the brightness value, which should be set whenever switching on via the "switching" or "central switching" object or by manual operation on the dimming channel. The switch-on brightness must always be between the upper and lower brightness limit value of the dimming range.</p> <p>The selection of "basic brightness" is not necessary when using a minimum brightness.</p> <p>In the "Memory value" setting, the active and internally saved brightness value prior to switching off last time is set when switching on (via the "switching" or "central switching" object).</p>	
On receipt of a brightness value	jumping to dimming to fading
<p>A parameter is used here to define whether a brightness value received via the bus is instantly jumped to (absolute dimming), or whether the brightness is dimmed to via the set dimming characteristic. Fading is also possible as an alternative. When fading, the received brightness value is reached in the exact configured fading time irrespective of the dimming characteristic and irrespective of which brightness value the dimming procedure was started at. Thus, for example, several dimming outputs can be set to the same brightness at the same time.</p>	
Time for brightness value via fading	0 ... 20 ... 240 s
<p>The fading time is set here if fading is predefined in the dimming behaviour. A dimming procedure via fading lasts for the exact configured time. If "0" is set, the brightness value is jumped to directly.</p>	

With relative dimming up in the switched-off state	switch ON channel no reaction
<p>This parameter defines whether or not a dimming channel in the "OFF" state reacts to a relative dimming telegram.</p> <p>Switch on channel: The dimming channel always reacts to a relative dimming telegram and executes a dimming process. In the "OFF" state, the channel switches on with a "dim up" telegram.</p> <p>No reaction: The dimming channel only reacts to a relative dimming telegram when it is switched on. In the "OFF" state, the channel ignores a "dim up" telegram.</p>	

10.8 Times

Delay after bus voltage return

To reduce telegram traffic on the KNX bus line after bus voltage activation (bus reset), after connection of the device to the bus line or after an ETS programming operation, it is possible to delay all actively transmitted status or feedback telegrams of the switching function. For this purpose, a channel-independent delay can be specified (parameter "Delay after bus voltage return" on parameter page "General"). Only after the configured time elapses are feedback telegrams for initialisation transmitted to the KNX.

Which of the telegrams is actually delayed can be set for each output and status function separately.

- i** The delay has no effect on the behaviour of the outputs. Only the bus telegrams for status or feedback are delayed. The outputs can also be activated during the delay after bus voltage return.
- i** A setting of "0" for the delay after bus voltage return deactivates the delaying function altogether. In this case, any messages, if actively transmitted, will be transmitted to the KNX without any delay.

Time for flashing of the disabling function

A disabling function can be activated separately for each channel as an additional function. With this disabling function it is possible to have the output flash at the start or end of disabling. The time for flashing is set collectively for all channels.

10.8.1 General times parameter

General -> Times

Delay after bus voltage return	0 ... 59 min 0 ... 17 ... 59 s
To reduce telegram traffic on the bus line after bus voltage activation (bus reset), after connection of the device to the bus line or after programming with the ETS, it is possible to delay all active feedback telegrams of the actuator. The parameter specifies in this case a delay valid for all devices. Only after the time configured here has elapsed are feedback telegrams for initialisation transmitted to the bus.	
Time for flashing of the disabling function	1 s, 2 s, 5 s, 10 s
At the start and end of the "disable" supplementary function, a dimming channel can flash. The flash cycle time is generally set here for all dimming channels concerned.	

10.9 Reset behaviour

Response after a device reset

Behaviour of the dimming channels in case of bus voltage failure or after programming with the ETS is permanently set to "no reaction". Behaviour of the dimming channels in case of bus voltage return can be set.

Behaviour after ETS programming

- i** The actuator briefly initialises after each ETS programming operation. Dimming channels whose load type is configured to "universal" calibrate themselves to the load. The calibration procedure becomes noticeable during ohmic loads by a brief flicker and lasts up to 10 seconds depending on the network conditions.
- i** A switching state and brightness value set after an ETS programming cycle is added to the feedback objects. Actively transmitting feedback objects also only first transmit after an ETS programming cycle when the initialisation has finished and, if necessary, the "delay time after bus voltage return" has elapsed.
- i** An active manual operation mode will be terminated by an ETS programming operation.
- i** After an ETS programming operation, the disabling function is always deactivated. The brightness values saved in case of the bus voltage failure are deleted.

Behaviour in case of bus voltage failure

- i** Active disabling functions are cancelled and remain inactive until they are re-activated.
- i** In case of a bus voltage failure, the current brightness values of all dimming channels are permanently saved internally so that these brightness values can be reset after bus voltage return if this is configured in the ETS. The data is stored before the configured reaction for bus voltage failures takes place and only if the bus voltage has been available before without interruption for at least 20 seconds after the last reset (storage capacitors sufficiently charged for storage purposes). In all other cases nothing is stored (brightness value = "0").

Behaviour after bus voltage return

The parameter "Behaviour after bus voltage return" is created separately for each dimming channel on the parameter page "Dax - General" (x = number of dimming channel 1...4).

- Set the parameter to "Brightness value (100%)".
After bus voltage return, the dimming channel is set to maximum brightness.
- Set the parameter to "no reaction".

On bus voltage return, the dimming channel shows no reaction and remains in the brightness state currently selected or is switched off.

- i** When the bus voltage is switched on, the brightness value is set to "0 %" if no mains voltage is switch on at the time of bus voltage return on the load outputs.
- i** In the "No reaction" setting: On return of bus voltage with permanently switched on mains voltage, the corresponding dimming channel shows no response and remains in the brightness state last selected
- i** The actuator briefly initialises after switching on the mains voltage each time. Dimming channels whose load type is configured to "universal" calibrate themselves to the load. The calibration procedure becomes noticeable during ohmic loads by a brief flicker and lasts up to 10 seconds depending on the network conditions.
- i** A switching state and brightness value set after bus voltage return is tracked in the feedback objects. Actively transmitting feedback objects first transmit, however, after bus or mains voltage return when the initialisation of the actuator has finished, and if necessary the "delay time after bus voltage return" has elapsed.
- i** In the case of enabling function as supplementary function: Active disabling functions are always inactive after bus voltage return.
- i** After return of bus voltage a manual control will be interrupted..

10.9.1 Reset behaviour parameters

Dimming channel ... -> DO... - General -> Reset behaviour

After ETS programming operation	no reaction
The behaviour of the actuator after ETS programming is specified as a fixed value, and cannot be adjusted. The actuator retains the current brightness value.	
In case of bus voltage failure	no reaction
The behaviour of the actuator is predefined in case of bus voltage failure. The actuator retains the current brightness value.	
After bus voltage return	no reaction Brightness value (100%)
The actuator allows the brightness value to be set separately for each dimming channel after bus voltage return.	
No reaction: On bus voltage return, the actuator retains the current brightness value.	
After bus voltage return, the dimming channel is set to the predefined brightness value.	

10.10 Channel-oriented feedback

The actuator can track the current switching state and brightness value of a dimming channel via separate feedback objects and can also transmit them to the bus, if the bus voltage is on. The following feedback objects can be enabled independently of each other for each channel ...

- Feedback switching status (1 bit)
- Feedback brightness value (1 byte)

The actuator calculates the object value of the feedback objects during each switching or dimming procedure. The actuator tracks the switching state or brightness value and updates the feedback objects even when a dimming channel is activated by the manual operation or scene function.

10.10.1 Switching status feedback

The switching status feedback object is updated internally after the following events ...

- Immediately after switching on a dimming channel (if necessary, first after a switch-on delay has elapsed and at the beginning of a soft ON dimming procedure / also after a staircase function).
- After switching off a dimming channel (if necessary, first after a run-on-time has elapsed and at the end of a soft OFF dimming procedure / also after a staircase function).
- Immediately after switching off by means of the automatic switch-off function.
- At the beginning of a dimming procedure when dimming on (relatively high dimming or brightness value = 1...100 %) a dimming channel.
- At the end of a dimming procedure when dimming off (brightness value = 0 %) a dimming channel.
- Only when the switching state changes (therefore not for dimming procedures that do not change the switching state e.g. from 10 % to 50 % brightness).
- During updating of the switching state from "ON" to "ON" when the dimming channel is already switched on.
- During updating of the switching state from "OFF" to "OFF" when the dimming channel is already switched off.
- Always at the start or end of a disabling function (only if the switching state changes as a result).
- Always after bus voltage return, in the case of mains voltage failure ("OFF") or at the end of any ETS programming process (if necessary also delayed and after calibration of the load).

Activate switching status feedback

The switching status feedback can be used as an active message object or as a passive status object. As an active message object, the switching status feedback information is also directly transmitted to the KNX whenever the feedback value is up-

dated. As a passive status object, there is no telegram transmission after an update. In this case, the object value must be read out. The ETS automatically sets the object communication flags required for proper functioning.

The parameter "Switching status" exists separately for each output on the parameter page "Dimming channel ... -> DO... - General -> Feedback telegrams". Feedback takes place via the "Switching feedback" object.

Precondition:

The feedback must be enabled on the parameter page "Dimming channel ... -> DO... - General -> Enabled" functions.

- Set the parameter to "Feedback is active signalling object".
A switching status is transmitted as soon as it is updated. An automatic telegram transmission of the feedback takes place after bus voltage return or after programming with the ETS.
- Set the parameter to "Feedback is passive status object".
A switching status will be transmitted in response only if the feedback object is read out from by the KNX. No automatic telegram transmission of the feedback takes place after bus voltage return or after programming with the ETS.
- Set the parameter to "no reaction".
The switching status feedback of the affected dimming channel is deactivated.

i Feedback of the current switching status via the "switching" object is not possible.

Set update of "Switching feedback"

In the ETS, you can specify when the actuator should update the feedback value for the switching status (object "Switching feedback") in case of an actively transmitting communication object. The object value updated by the actuator is then signalled actively to the KNX.

The parameter "Update of the object value" can be preset separately for each switching output on the parameter page "Dimming channel ... -> DO... - General -> Feedback telegrams".

Precondition:

The feedback must be enabled on the parameter page "Dimming channel ... -> DO... - General -> Enabled" functions. In addition, the switching status feedback must be configured to actively transmitting.

- Set the parameter to "after each update object 'Switching'/'Central'".
The actuator updates the feedback value in the object once a new telegram is received on the input objects "Switching" or "Central switching" or the switching state changes internally (e.g. through a time function). With an actively transmitting feedback object, a new telegram is also then actively transmitted to the KNX each time. The telegram value of the feedback does not necessar-

ily have to change in the process. Hence, a corresponding switching status feedback is also generated on the "Switching" object such as in the case of cyclical telegrams for example.

- Set the parameter to "Only if the feedback value changes".

The actuator only updates the feedback value in the object if the telegram value (e.g. "OFF" to "ON") also changes or the switching state changes internally (e.g. through a time function). If the telegram value of the feedback does not change (e.g. in the case of cyclical telegrams to the "Switching" object with the same telegram value), the actuator does not transmit any feedback. Consequently, with an actively transmitting feedback object, no telegram with the same content will be transmitted repeatedly either.

This setting is recommendable, for instance, if the "Switching" and "Switching feedback" objects are linked to an identical group address. This is often the case when activating by means of light scene push-button sensors (recall and storage function).

Setting switching status feedback on bus voltage return or after programming with the ETS

If used as active message object, the switching status feedback states are transmitted to the KNX after bus voltage return or after programming with the ETS. In these cases, the feedback can be delayed with the delay being collectively preset globally for all outputs.

- Activate the parameter "Delay after bus voltage return" on the parameter page "Dimming channel ... -> DO... - General ->Feedback telegrams".

The switching status telegram is transmitted with a delay after bus voltage return or after an ETS programming operation. No feedback telegram is transmitted during a running delay, even if the switching state changes during this delay.

- Deactivate the parameter.

The switching status telegram is transmitted immediately after bus voltage return or after an ETS programming operation.

Setting cyclical transmission of the switching status feedback telegram

The switching status feedback telegrams can, if active, also be transmitted cyclically, in addition to the transmission after updating.

- Activate the parameter "Cyclical transmission" on the parameter page "Dimming channel ... -> DO... - General ->Feedback telegrams".

Cyclical transmission is activated. The cycle time for the switching status feedback can be configured separately for the parameter "Time for cyclical transmission".

- Deactivate the parameter.

Cyclical transmission is deactivated so that the feedback is transmitted to the KNX only when updated by the actuator.

10.10.2 Brightness value feedback

The brightness value feedback object is updated internally after the following events ...

- At the end of a relative (4-bit) or absolute (1-byte) dimming procedure.
- After switching on a dimming channel, if the switch-on brightness is set (if necessary, first after a switch-on delay has elapsed and at the end of a soft ON dimming procedure / also after a staircase function).
- After switching off a dimming channel (if necessary, first after a run-on-time has elapsed and also after a staircase function).
- Immediately after switching off by means of the automatic switch-off function.
- Only if the brightness value changes (if a brightness value specification under-shoots the minimum brightness as a result of relative or absolute dimming from outside or exceeds the maximum brightness, the actuator does not update a brightness value feedback according to the minimum brightness or maximum brightness).
- Always at the start or end of a disabling function (only if the brightness value changes as a result).
- Always after bus voltage return, in the case of mains voltage failure ("0") or at the end of any ETS programming process (if necessary, also delayed and after calibration of the load)

i In the case of enabling function as supplementary function: A 'flashing' dimming channel is always signalled back as "switched on" and with switch-on brightness. Switching status feedbacks are also transmitted for disabled channels when the channels are readjusted by a manual operation, for example.

Activate brightness value feedback

The brightness value feedback can be used as an active message object or as a passive status object. As an active signalling object, the brightness value feedback is also directly transmitted to the KNX for each update of the feedback value. As a passive status object, there is no telegram transmission after an update. In this case, the object value must be read out. The ETS automatically sets the object communication flags required for proper functioning.

The parameter "Brightness value" exists separately for each output on the parameter page "Dimming channel ... -> DO... - General -> Feedback telegrams". Feedback takes place via the "Brightness value feedback" object.

Precondition:

The feedback must be enabled on the parameter page "Dimming channel ... -> DO... - General -> Enabled" functions.

- Set the parameter to "Feedback is active signalling object".
A brightness value is transmitted once this is updated. An automatic telegram transmission of the feedback takes place after bus voltage return or after programming with the ETS.
- Set the parameter to "Feedback is passive status object".

A brightness value is transmitted in response only if the feedback object is read out by the KNX. No automatic telegram transmission of the feedback takes place after bus voltage return or after programming with the ETS.

- Set the parameter to "no reaction".

The brightness value feedback of the affected dimming channel is deactivated.

Setting the update of the "Brightness value feedback"

In the ETS you can specify when the actuator should update the feedback value for the brightness value ("Brightness value feedback" object) in case of an actively transmitting communication object. The object value updated by the actuator is then signalled actively to the KNX.

The parameter "Update of the object value" can be preset separately for each output on the parameter page "Dimming channel ... -> DO... - General -> Feedback telegrams".

Precondition:

The feedback must be enabled on the parameter page "Dimming channel ... -> DO... - General -> Enabled" functions. In addition, the brightness value feedback must be configured to actively transmitting.

- Set the parameter to "after each update 'Brightness value'/'Central brightness value' object".

The actuator updates the feedback value in the object once a new telegram is received on the input objects "Brightness value" or "Central brightness value" or the brightness value changes internally (e.g. through a time function). With an actively transmitting feedback object, a new telegram is also then actively transmitted to the KNX each time. The telegram value of the feedback does not necessarily have to change in the process. Hence, a corresponding brightness value feedback is also generated on the "brightness value feedback" object such as in the case of cyclical telegrams for example.

- Set the parameter to "Only if the feedback value changes".

The actuator only updates the feedback value in the object if the telegram value (e.g. "1 %" to "2 %") also changes or the brightness value changes internally (e.g. through a time function). If the telegram value of the feedback does not change (e.g. in the case of cyclical telegrams to the "Brightness value" object with the same telegram value), the actuator does not transmit any feedback. Consequently, with an actively transmitting feedback object, no telegram with the same content will be transmitted repeatedly either.

This setting is recommendable, for instance, if the "brightness value" and "brightness value feedback" objects are linked to an identical group address. This is often the case when activating by means of light scene push-button sensors (recall and storage function).

Setting feedback for voltage return or ETS programming

If used as active signalling object, the brightness value feedback states are transmitted to the KNX after voltage return or after ETS programming.

The feedback telegram can be transmitted with a time delay (parameter "Delay after voltage return"). The delay is collectively preset globally for all outputs.

- i** No feedback is transmitted during a running time delay.

Setting cyclical transmission of the brightness value feedback

The brightness value feedback telegrams can, if active, also be transmitted cyclically, in addition to transmission after updating.

- Activate the parameter "Cyclical transmission" on the parameter page "Dimming channel ... -> DO... - General ->Feedback telegrams".
Cyclical transmission is activated. The cycle time for the brightness value feedback can be configured separately for the parameter "Time for cyclical transmission".
- Deactivate the parameter.
Cyclical transmission is deactivated so that the feedback is transmitted to the KNX only when updated by the actuator.

10.10.3 Feedback telegrams parameter

Dimming channel ... -> DO... - General -> Enabled functions

Feedback	Checkbox (yes / no)
This parameter can be used to disable or to enable the feedback functions.	

Dimming channel ... -> DO... - General -> Feedback telegrams

switching status	no feedback feedback is active signalling object feedback is passive status object
------------------	---

The current switching state of the dimming output can be reported separately back to the KNX.

No feedback: The switching status feedback of the affected dimming channel is deactivated.

Feedback is active signalling object: A switching status is transmitted as soon as it is updated. An automatic telegram transmission of the feedback takes place after bus voltage return or after programming with the ETS.

Feedback is passive status object: A switching status will be transmitted in response only if the feedback object is read out by the KNX. No automatic telegram transmission of the feedback takes place after bus voltage return or after programming with the ETS.

Updating of the object value	after each update object "Switching" only if the feedback value changes
------------------------------	---

Here, you can specify when the actuator should update the feedback value for the switching status (object "Switching feedback") in case of an actively transmitting communication object. The object value updated by the actuator is then signalled actively to the KNX.

This parameter is only visible in case of an actively transmitting feedback.

after each update object "Switching": The actuator updates the feedback value in the object once a new telegram is received on the input objects "Switching" or the switching state changes internally (e.g. through a time function). With an actively transmitting feedback object, a new telegram is also then actively transmitted to the KNX each time. The telegram value of the feedback does not necessarily have to change in the process. Hence, a corresponding switching status feedback is also generated on the "Switching" object such as in the case of cyclical telegrams for example.

only if the feedback value changes: The actuator only updates the feedback value in the object if the telegram value (e.g. "OFF" to "ON") also changes or the switching state changes internally (e.g. through a time function). If the telegram value of the feedback does not change (e.g. in the case of cyclical telegrams to the "Switching" object with the same telegram value), the actuator does not transmit any feedback. Consequently, with an actively transmitting feedback object, no telegram with the same content will be transmitted repeatedly either.

Delay after bus voltage return	Checkbox (yes / no)
<p>The states of the switching status feedback can be transmitted to the KNX with a delay after bus voltage return or after an ETS programming operation. The activated parameter causes a delay on bus voltage return. The delay time is configured on the parameter page "General -> Times".</p> <p>This parameter is only visible in case of an actively transmitting feedback.</p>	
Cyclical transmission	Checkbox (yes / no)
<p>The switching status feedback telegrams can, if actively transmitting, also be transmitted cyclically, in addition to the transmission after updating.</p> <p>This parameter is only visible in case of an actively transmitting feedback.</p> <p>Parameter activated: Cyclical transmission is activated.</p> <p>Parameter deactivated: Cyclical transmission is deactivated so that the feedback is transmitted to the KNX only when updated by the actuator.</p>	
brightness value	no feedback feedback is active signalling object feedback is passive status object
<p>The current brightness value of the dimming output can be reported back separately to the KNX.</p> <p>No feedback: The brightness value feedback of the affected dimming channel is deactivated.</p> <p>Feedback is active signalling object: The brightness value is transmitted as soon as it is updated. An automatic telegram transmission of the feedback takes place after bus voltage return or after programming with the ETS.</p> <p>Feedback is passive status object: The brightness value will be transmitted in response only if the feedback object is read out by the KNX. No automatic telegram transmission of the feedback takes place after bus voltage return or after programming with the ETS.</p>	

Updating of the object value	after each update obj. "Brightness value" only if the feedback value changes
<p>Here, you can specify when the actuator should update the feedback value for the switching status (object "Brightness value feedback") in case of an actively transmitting communication object. The object value updated by the actuator is then signalled actively to the KNX.</p> <p>This parameter is only visible in case of an actively transmitting feedback.</p> <p>after each update "Brightness value" object: The actuator updates the feedback value in the object once a new telegram is received on the "Brightness value" input objects or once the value changes internally (e.g. due to a dimming function). With an actively transmitting feedback object, a new telegram is also then actively transmitted to the KNX each time. The telegram value of the feedback does not necessarily have to change in the process. Hence, a corresponding brightness value feedback is also generated on the "brightness value" object such as in the case of cyclical telegrams for example.</p> <p>only if the feedback value changes: The actuator only updates the feedback value in the object if the brightness value also changes or the switching state changes internally (e.g. through a time function). If the telegram value of the feedback does not change (e.g. in the case of cyclical telegrams to the "Brightness value" object with the same telegram value), the actuator does not transmit any feedback. Consequently, with an actively transmitting feedback object, no telegram with the same content will be transmitted repeatedly either.</p>	
Delay after bus voltage return	Checkbox (yes / no)
<p>The states of the brightness value feedback can be transmitted to the KNX with a delay after bus voltage return or after an ETS programming operation. The activated parameter causes a delay on bus voltage return. The delay time is configured on the parameter page "General -> Times".</p> <p>This parameter is only visible in case of an actively transmitting feedback.</p>	
Cyclical transmission	Checkbox (yes / no)
<p>The brightness value feedback telegrams can, if active, also be transmitted cyclically, in addition to transmission after updating.</p> <p>This parameter is only visible in case of an actively transmitting feedback.</p> <p>Parameter activated: Cyclical transmission is activated.</p> <p>Parameter deactivated: Cyclical transmission is deactivated so that the feedback is transmitted to the KNX only when updated by the actuator.</p>	
Time for cyclical transmission	<p>0...23 h</p> <p>0 ... 2 ... 59 min</p> <p>0 ... 59 s</p>
<p>These parameters define the time for cyclic transmission of switching status feedback and brightness value feedback.</p> <p>Setting the cycle time. These parameters are only available if cyclic transmission is activated for the switching status or brightness value.</p>	

10.10.4 Feedback object list

Object no.	Function	Name	Type	DPT	Flag
32, 52, 72, 92	Switching feedback	Dimming channel ... (...) - Output	1-bit	1,001	C, R, -, T, A
1-bit object for feedback signalling of the switching state ("1" = on / "0" = off) to the bus.					
Object no.	Function	Name	Type	DPT	Flag
36, 56, 76, 96	Feedback brightness value	Dimming channel ... (...) - Output	1 bytes	5,001	C, R, -, T, A
1-byte object for feedback signalling of an absolute dimming value (brightness value 0...255) to the bus.					

10.11 Time delays

Up to two time functions can be preset for each dimming output, independently of each other. The time functions affect the communication objects "Switching" only (if at least one of the central functions is activated for the output concerned) and delay the object value received depending on the telegram polarity.

- i** At the end of a disabling function, the switching state received during the function or set before the function can be tracked. At the same time, residual times of time functions are also tracked if these had not yet fully elapsed at the time of the reactivation.
- i** The time delays do not influence the staircase function if this is enabled.
- i** A time delay still in progress will be fully aborted by a reset of the actuator (bus voltage failure or ETS programming).

Activating switch-on delay

The switch-on delay can be activated separately in the ETS for each dimming output.

Precondition:

The time delays must be enabled on the parameter page "Dimming channel ... -> DO... - General -> Enabled" functions.

- Activate the checkbox "switch-on delay". Configure the desired switch-on delay.

The switch-on delay is enabled. After reception of an ON telegram via the "switching" object, the configurable time is started. Another ON-telegram triggers the time only when the parameter "Switch-on delay retriggerable" is activated. An OFF-telegram received during the ON-delay will end the delay and sets the switching status to "OFF".

Activating switch-off delay

The switch-off delay can be activated separately in the ETS for each dimming output.

Precondition:

The time delays must be enabled on the parameter page "Dimming channel ... -> DO... - General -> Enabled" functions.

- Activate the checkbox "switch-off delay". Configure the desired switch-off delay.

The switch-off delay is enabled. After reception of an OFF-telegram via the "switching" object, the configurable time is started. Another OFF-telegram triggers the time only when the parameter "switch-off delay retriggerable" is activated. An ON-telegram received during the OFF-delay will end the delay and sets the switching status to "ON".

10.11.1 Time delays parameters

Dimming channel ... -> DO... - General -> Enabled functions

Time delays	Checkbox (yes / no)
This parameter can be used to disable or to enable the time delays. The parameter is deactivated if cyclical monitoring is enabled.	

Dimming channel ... -> DO... - General -> Time delays

Switch-on delay	Checkbox (yes / no)
The communication objects "Switching" or "Central switching" can be evaluated after a time delay. This parameter enables the switch-on delay and thereby activates the necessary parameters.	

Switch-on delay	0...59 min 0...10...59 s
This parameter is used for setting the duration of the switch-on delay.	

Switch-on delay retriggerable	Checkbox (yes / no)
A switch-on delay still in progress can be retriggered by another "ON" telegram (parameter activated). Alternatively, the retriggering time (parameter deactivated) can be suppressed. The parameters for the switch-on delay are only visible if switch-on delay or switch-on and switch-off delay are activated.	

Switch-off delay	Checkbox (yes / no)
The communication objects "Switching" or "Central switching" can be evaluated after a time delay. This parameter enables the switch-off delay and thereby activates the necessary parameters.	

Switch-off delay	0...59 min 0...10...59 s
This parameter is used for setting the duration of the switch-off delay.	

Switch-off delay retriggerable	Checkbox (yes / no)
A switch-off delay still in progress can be retriggered (parameter activated) by another "OFF" telegram. Alternatively, the retriggering time (parameter deactivated) can be suppressed. The parameters for the switch-off delay are only visible if switch-on delay or switch-on and switch-off delay are activated.	

10.12 Scene function

Up to 16 scenes can be programmed and scene values stored separately for each dimming channel. The scene values are recalled or stored via a separate scene extension object. The data point type of the extension object permits addressing of all 64 scenes.

The scene function must be enabled on the parameter page "Dimming channel ... -> DO... - General ->Enabled functions" for each dimming channel in order for the required communication objects and parameters (on the parameter page "Dimming channel ... -> DO... - General -> Scenes") to become visible.

The number of scenes used can be selected anywhere in the range 1 to 16. The parameter "Number of scenes" decides how many scenes are visible for the switching output in the ETS and can therefore be used. It is possible to specify which scene number (1 ... 64) controls each scene.

The scene function can be combined together with other functions of a dimming channel, whereby the last received or preset state is always executed: Telegrams to the "Switching", "Dimming" or "Brightness value" objects, a scene recall or scene storage telegram at the time of an active staircase function aborts the staircase time prematurely and presets the brightness state according to the received object value (delays are also taken into account) or scene value. Similarly, the state of the dimming channel, which was preset by the "Switching", "Dimming" or "Brightness value" objects or by a scene recall, can be overridden by a staircase function.

Presetting a scene recall delay

Each scene recall of an dimming channel can optionally also be delayed. With this feature, dynamic scene sequences can be configured if several scene outputs are combined with cyclical scene telegrams.

Precondition

The scene function must be enabled on the parameter page "Dimming channel ... -> DO... - General -> Enabled functions".

- on the parameter page "Dimming channel ... -> DO... - General -> Scenes" activate the parameter "Delay scene recall".

The delay time is now activated and can be configured separately. The delay only influences the scene recall of the dimming channel. The delay time is started on arrival of a recall telegram. The corresponding scene will be recalled and the brightness value set on the dimming channel only after this time has elapsed.

- i** Each scene recall telegram restarts the delay time and retriggers it. If a new scene recall telegram is received while a delay is active (scene recall not yet executed), the old (and not yet recalled scene) will be rejected and only the scene last received executed.

- i** The scene recall delay has no influence on the storage of scene values. A scene storage telegram within a scene recall delay terminates the delay and thus the scene recall.

Presetting the behaviour during ETS programming

During storage of a scene, the brightness values are permanently stored internally in the device. To prevent the stored values from being replaced during ETS programming of the application or of the parameters by the originally programmed scene brightness values, the actuator can inhibit overwriting of brightness values. As an alternative, the original values can be reloaded into the device during each programming run of the ETS.

Precondition

The scene function must be enabled on the parameter page "Dimming channel ... -> DO... - General -> Enabled functions".

- on the parameter page "Dimming channel ... -> DO... - General -> Scenes", activate the parameter "Overwrite values stored in the device during the ETS programming operation".

During each ETS programming of the application or of the parameters, the scene brightness values parameterized in the ETS for the dimming channel concerned will be programmed into the actuator. Any scene brightness values stored in the device by means of a storage function will be overwritten.

- Deactivate the parameter "Overwrite values stored in the device during the ETS programming operation".

Scene brightness values stored in the device by means of a storage function will be maintained. If no scene brightness values have been stored, the brightness values last programmed in the ETS remain valid.

- i** When the actuator is commissioned for the first time, this parameter should be activated so that the brightness values are initialised to valid scene brightness values.

Setting scene numbers and scene switching states

The scene number (1...64) with which the scene is addressed, i.e. recalled or stored, must be determined for each internal scene of the dimming channel. The data point type of the scene extension object permits addressing of all scenes.

In addition to specifying the scene number, it is necessary to define which scene command (ON, OFF) should be set on the dimming channel during a scene recall.

Precondition

The scene function must be enabled on the parameter page "Dimming channel ... -> DO... - General -> Enabled functions".

- On the parameter page "Dimming channel ... -> DO... - General -> Scenes", set the parameter for each scene to the numbers with which the scenes are to be addressed.

A scene can be addressed with the configured scene number. A setting of "0" deactivates the corresponding scene so that neither recalling nor storage is possible.

- i** If the same scene number is configured for several scenes, only the scene with the lowest sequential number will be addressed. The other scenes will be ignored in this case.
 - on the parameter page "Dimming channel ... -> DO... - General -> Scenes", set the parameter "Brightness value" to the desired value for each scene.
During a scene recall, the parameterized brightness value is recalled and set on the dimming channel.
- i** The parameterized brightness value is adopted in the actuator during programming with the ETS only if the parameter "Overwrite values stored in the device during ETS download" is activated.

Presetting storage behaviour

The switching state set for the dimming channel can be stored internally via the extension object on receipt of a scene storage telegram. In this case, the switching state can be influenced before the storage by all functions of the dimming channel, provided that the individual functions have been enabled (e.g. also the disabling function, forced position function etc.).

Precondition

The scene function must be enabled on the parameter page "Dimming channel ... -> DO... - General -> Enabled functions".

- on the parameter page "Dimming channel ... -> DO... - General -> Scenes" activate the parameter "storage function" for each scene.
The storage function is activated for the scene in question. On reception of a storage telegram via the "Scene extension" object, the current switching state will be internally stored.
- Deactivate the parameter "storage function" for each scene.
The storage function is deactivated for the scene in question. A storage telegram received via the "scene extension" object will be rejected.

10.12.1 Scene function parameters

Dimming channel ... -> DO... - General -> Enabled functions

Scene function	Checkbox (yes / no)
This parameter can be used disable or to enable the scene function. The parameter is deactivated if cyclical monitoring is enabled.	

Dimming channel ... -> DO... - General: -> Scenes

Delay scene recall	Checkbox (yes / no)
A scene is recalled via the scene extension object. If required, the scene recall can be delayed on reception of a recall telegram (parameter activated). The recall is alternatively made immediately on reception of the telegram (parameter deactivated).	

Delay time	0...59 min 0...10...59 s
These parameters specify the duration of the scene delay time.	

On scene request	Jumping to brightness value Dimming to brightness value via dimming increm. time Dimming brightness value via fading
When recalling a scene, the configured or stored scene value is set for the dimming channel concerned. This parameter setting can define whether the brightness value can be instantly jumped to or dimmed to or is set via fading. When fading, the brightness value to be set is reached in the exact configured fading time irrespective of the dimming characteristic of a channel and irrespective of which brightness value the dimming procedure was started at. Thus, for example, several dimming channels can be set to the same brightness at the same time.	

Dimming increment time	0 ... 5... 255 ms
Setting of the dimming increment time if the brightness value of a scene should be dimmed. This parameter is visible only if the parameter "Behaviour when recalling a scene" is set to "Dim to brightness value via dimming increment time".	

Time for brightness value via fading	0 ... 2 ... 240 s
Setting of the fading time if the brightness value of a scene should be dimmed to via fading. This parameter is visible only if the parameter "behaviour when recalling a scene" is set to "dim to brightness value via fading".	

Visual feedback for storage function	Checkbox (yes / no)
<p>Optionally, a visual feedback via the dimming output can be signaled when executing a storage command. The channel flashes once as feedback in the configured flashing time.</p> <p>Parameter activated: When a storage function is executed, the visual feedback is activated immediately. The output switches to the opposite switching state for the duration of the configured flashing time and then back to the saved scene command.</p> <p>Parameter deactivated: When storing a scene, the visual feedback is not executed. The actuator adopts the current state of the output without special feedback.</p>	
Flashing time (0...10)	0...5...10
<p>The flashing time in which the visual feedback is to be executed is set here.</p> <p>This parameter is only visible when visual feedback is used.</p>	
Overwrite values stored in the device during the ETS programming operation	Checkbox (yes / no)
<p>During storage of a scene, the scene values (current states of the dimming outputs concerned) are stored internally in the device. To prevent the stored values from being replaced during ETS programming by the originally programmed scene values, the actuator can inhibit overwriting of the scene values (parameter deactivated). As an alternative, the original values can be reloaded into the device during each programming run of the ETS (parameter activated).</p>	
Number of scenes (1...16)	1...10...16
<p>This parameter defines how many scenes are visible for the dimming channel in the ETS and can therefore be used.</p>	
Scene number	0...1*...64
	*: The predefined scene number is dependent on the scene (1...64).
<p>The number of scenes used can be selected anywhere in the range 1 to 16. It is then possible to preset which scene number (1 ... 64) controls each scene. A setting of "0" deactivates the corresponding scene so that neither recalling nor storage is possible. If the same scene number is configured for several scenes, only the scene with the lowest sequential number will be addressed. The other scenes will be ignored in this case.</p>	
brightness value	switch off Basic brightness 5 % ... 100 %
<p>This parameter is used for configuring the value which is set when the scene is recalled.</p>	

Memory function	Checkbox (yes / no)
<p>If the parameter is activated, the storage function of the scene is enabled. The current switching state can then be stored internally via the extension object on receipt of a storage telegram. If the parameter is deactivated, the storage telegrams are rejected.</p>	

10.12.2 Object list scene function

Object no.	Function	Name	Type	DPT	Flag
38, 58, 78, 98	Scene extension	Switching... - Input	1 bytes	18,001	C, (R), W, -, A
1-byte object for polling or saving a scene.					

10.13 Staircase function

The staircase function can be used for implementing time-controlled lighting of a staircase or for function-related applications. The staircase function must be enabled in the ETS on the parameter page "Dimming channel ... -> DO... - General -> Enabled functions", in order for the required communication objects and parameters to be visible.

The staircase function is activated via the communication object "staircase function start / stop" and is independent of the "switching" object of a dimming channel. In this way, parallel operation of time and normal control is possible, whereby the command last received is always executed: A telegram to the "switching" object or a scene recall at the time of an active staircase function aborts the staircase time prematurely and presets the switching state according to the received object value (the time delays are also taken into account) or scene value. Likewise, the switching state of the "switching" object can be overridden by a staircase function.

Time-independent continuous light switching can also be implemented in combination with a disabling function because the disabling function has a higher priority and overrides the switching state of the staircase function.

Furthermore, an extension of the staircase function can be implemented by means of a separate switch-on delay and pre-warning function. The pre-warning should, according to DIN 18015-2, warn any person still on the staircase that the light will soon be switched off. As an alternative to the pre-warning at the end of the staircase time, the actuator can activate reduced continuous lighting. In this way, for example, long, dark hallways can have permanent basic lighting.

Specifying switch-on behaviour of the staircase function

An ON telegram to the "Staircase function start/stop" object activates the staircase time (T_{ON}), the duration of which is defined by the parameters "Staircase time". In addition, a switch-on delay (T_{Delay}) can be activated (see "presetting switch-on delay of the staircase function"). At the end of the staircase time, the output switches off or activates optionally the pre-warning time ($T_{Prewarn}$) of the pre-warning function (see "presetting pre-warning function of the staircase function"). Taking into account any possible switch-on delay and pre-warning function, this gives rise to the switch-on behaviour of the staircase function as shown in the following diagram.

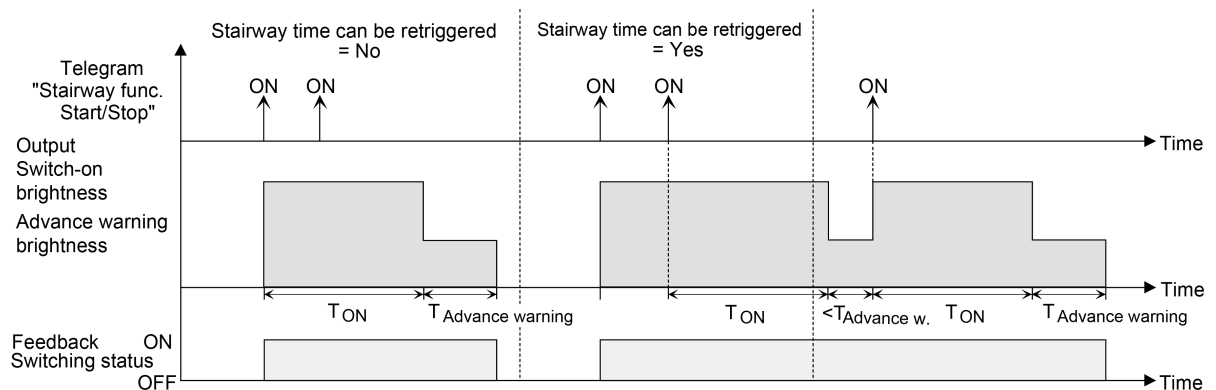

Image 12: Switch-on behaviour of the staircase function

The parameter "Staircase time retriggerable" specifies whether the staircase time can be retriggered.

Precondition:

The staircase function must be enabled on the parameter page "Dimming channel ... -> DO... - General -> Enabled functions".

- In the parameter "Staircase time" on the parameter page "Dimming channel ... -> DO... - General -> Staircase function", configure the required switch-on time of the staircase function.

- Activate parameter "Staircase time retriggerable".

Every ON telegram received during the ON phase of the staircase time retriggerers the staircase time completely.

- Deactivate parameter "Staircase time retriggerable".

ON telegrams received during the ON phase of the staircase time are rejected. The staircase time is not retriggered.

- i** An ON telegram received during the pre-warning time always retriggerers the staircase time independently of the parameter "Staircase time retriggerable".

Specifying switch-off behaviour of the staircase function

In the case of a staircase function, the reaction to an OFF telegram can also be configured on the object "staircase function start/stop". At the end of the staircase time, a dimming channel always shows the reaction "At the end of the staircase time" configured in the ETS, without the receipt of an OFF telegram. At the same time, the channel can switch off, optionally activate the pre-warning time (TVorwarn) of the pre-warning function or dim to the reduced continuous lighting (application: e.g. long, dark hallways). If, on the other hand, the dimming channel receives an OFF telegram via the object "Staircase function start/stop", the actuator evaluates the parameter "Reaction to an OFF-telegram". In this case, the channel can react immediately to the OFF telegram and end the staircase time prematurely. Alternatively, the OFF telegram can be ignored. Taking into account any possible pre-warning function, this gives rise to the example switch-off behaviour of the staircase function.

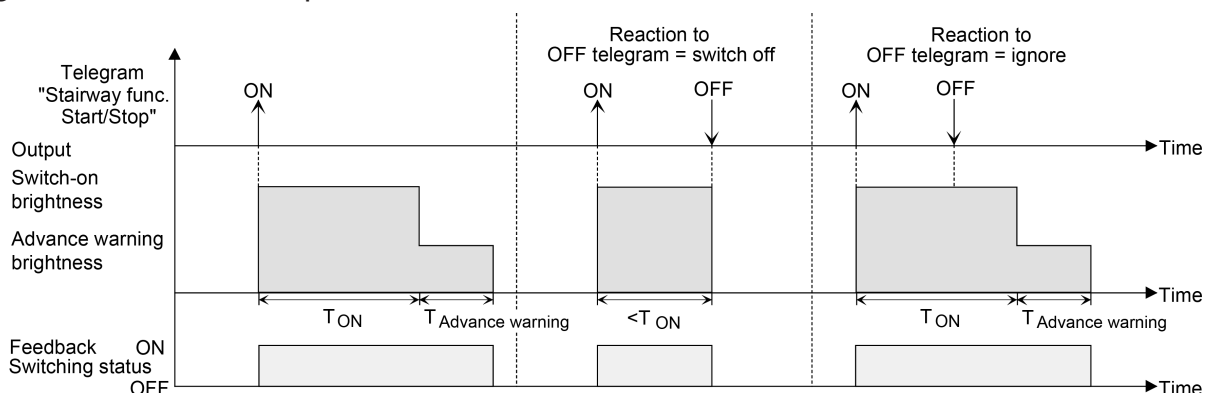

Image 13: Switch-off behaviour of the staircase function

The parameter "reaction to OFF-telegram" defines whether the staircase time (T_{ON}) of the staircase function can be aborted prematurely.

Precondition:

The staircase function must be enabled on the parameter page "Dimming channel ... -> DO... - General -> Enabled functions".

- Set parameter "Reaction to OFF-telegram" to "switch off".

As soon as an OFF telegram is received via the object "Staircase function start/stop" during the ON phase of the staircase time, the output switches off immediately. If the staircase time is stopped prematurely by such a telegram, there is no pre-warning, i.e. the pre-warning time is not started. There is also no dimming to a reduced continuous lighting. It is also possible to switch off prematurely during a dimming procedure of a soft function or during a pre-warning or reduced continuous lighting.

- Set parameter "Reaction to OFF-telegram" to ignore".

OFF telegrams received during the ON phase of the staircase time are rejected. The staircase time will be executed completely to the end with pre-warning if necessary.

- i** The parameter "Reaction to OFF telegram" does not influence the reception and the evaluation of OFF telegrams via the "Switching" object.

Setting the switch-on delay of the staircase function

An ON telegram for activation of the staircase function can also be evaluated with a time delay. This switch-on delay can be activated separately for the staircase function and has no influence on the configurable time delays for the object "switching".

Precondition:

The staircase function must be enabled on the parameter page "Dimming channel ... -> DO... - General -> Enabled functions".

- on the parameter page "Dimming channel ... -> DO... - General -> Staircase function" deactivate the parameter "Switch-on delay".

The switch-on delay is deactivated. After reception of an ON telegram on the object "Staircase function start/stop", the staircase time is activated immediately and the output switched on.

- Activate the parameter "switch-on delay".

The switch-on delay for the staircase function is enabled. The desired switch-on delay time can be specified. After reception of an ON telegram on the object "Staircase function start/stop", the switch-on delay is started. Another ON-telegram triggers the time only when the parameter "Switch-on delay retriggerable" is activated. The staircase time is activated and the output is switched on only after the time delay has elapsed.

- i** An OFF telegram via the object "Staircase function start/stop" during the switch-on delay only terminates the delay if the parameter "Reaction to OFF-telegram" is set to "switch off". Otherwise, the OFF telegram is ignored.

Setting the pre-warning function of the staircase function

At the end of the switch-on time of the staircase function, the actuator for the dimming channel concerned shows the reaction "At the end of the staircase time" configured in the ETS. The channel can be set to switch off immediately, alternatively to dim to the reduced continuous lighting (application: e.g. long, dark hallways) or to execute the pre-warning function. If the parameter is configured to "activate pre-warning time", the pre-warning time ($T_{Vorwarn}$) and pre-warning brightness can be configured in the ETS.

The pre-warning should, according to DIN 18015-2, warn persons still on the staircase that the light will soon be switched off. As a pre-warning, a dimming channel can be set to a pre-warning brightness before the channel switches off permanently. The pre-warning brightness is normally reduced in the brightness value compared to the switch-on brightness. The pre-warning time is added to the staircase time (T_{ON}). The pre-warning time influences the value of the feedback object so that the value "OFF" (in the case of non-inverted transmission) is first tracked after the pre-warning time in the object has elapsed.

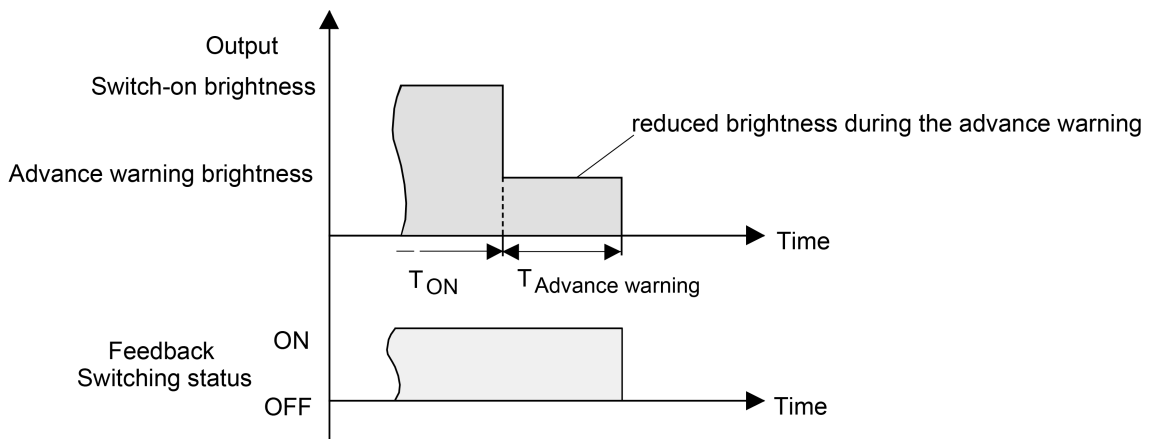

Image 14: The pre-warning function of the staircase function without soft OFF function

Additionally, the pre-warning function can also be extended by the soft OFF function. Taking into account any soft OFF function, this gives rise to a modified switch-off behaviour of the staircase function after the pre-warning has elapsed.

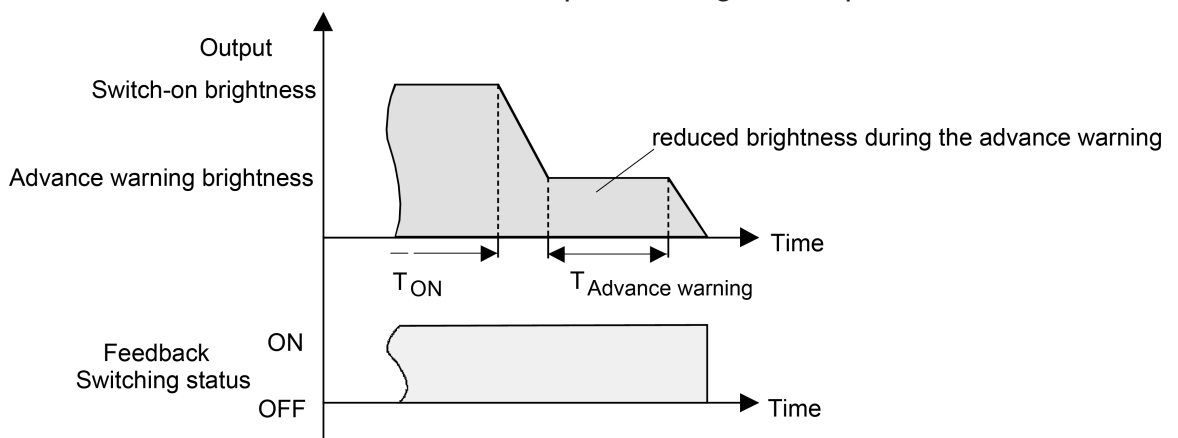

Image 15: The pre-warning function of the staircase function with soft OFF function (as an example with minimum brightness = 0%)

Precondition:

The staircase function must be enabled on the parameter page "Dimming channel ... -> DO... - General -> Enabled functions".

- on the parameter page "Dimming channel ... -> DO... - General -> Staircase function" set the parameter "At the end of the staircase time" to "activate pre-warning time".

The pre-warning function is enabled. The desired pre-warning time (T_{Prewarn}) can be preset.

- Set the parameter "Reduced brightness" to the desired value.

During the pre-warning time, the dimming channel is set to the configured brightness value.

i The configured value for the reduced brightness must be greater than or equal to the minimum brightness (if configured) or less than or equal to the maximum brightness!

i An ON telegram to the object "Staircase function start/stop" while a pre-warning function is still in progress stops the pre-warning time and always restarts the staircase time (independently of the parameter "Staircase time retriggerable"). Even during the pre-warning time, the parameter "reaction to OFF telegram" is evaluated so that a pre-warning in progress can be terminated early by switching off.

i An ON telegram to the object "Staircase function start/stop" while a pre-warning function is still in progress stops the pre-warning time and always starts (independently of the parameter "Staircase time retriggerable ?") the staircase time anew. Even during the pre-warning time, the parameter "reaction to OFF telegram" is evaluated so that a pre-warning in progress can be terminated early by switching off.

i Using the automatic switch-off function: The reduced brightness of the pre-warning does not start the switch-off function after reaching or undershooting the switch-off brightness!

Setting continuous lighting of the staircase function

At the end of the switch-on time of the staircase function, the actuator for the dimming channel concerned shows the "reaction at the end of the staircase time" configured in the ETS. The channel can be set to switch off immediately, alternatively to execute a pre-warning function, or to dim to reduced continuous lighting. The reduction of the lighting to continuous lighting after the staircase time has elapsed is appropriate, for example, if a certain degree of artificial light should be switched on permanently in long, dark hallways. Switching to switch-on brightness by activating the staircase function normally takes place by additional presence detectors or motion detectors when people are present in the hallway.

If the parameter "Reaction at the end of the staircase time" is configured to "activate reduced continuous lighting", the brightness for the continuous lighting can be configured in the ETS. The continuous brightness is normally reduced in the brightness value compared to the switch-on brightness.

The continuous lighting remains permanently active after the staircase time has elapsed. Only when an ON telegram is received again via the object "Staircase function start/stop" does the actuator switch back to the switch-on brightness and start counting the staircase time again. The receipt of an OFF telegram via the object "staircase function start/stop" only switches the continuous lighting off if the parameter "Reaction to OFF-telegram" is configured to "switch off".

- i** A dimming channel can always be switched on and off via the "switching" object independently of the staircase function. Consequently, continuous lighting will also be overridden if telegrams arrive on the actuator via the "switching" object. If permanent continuous lighting is desired, which cannot be influenced by the "switching" object nor by the object of the staircase function, the disabling function of the actuator should be used.

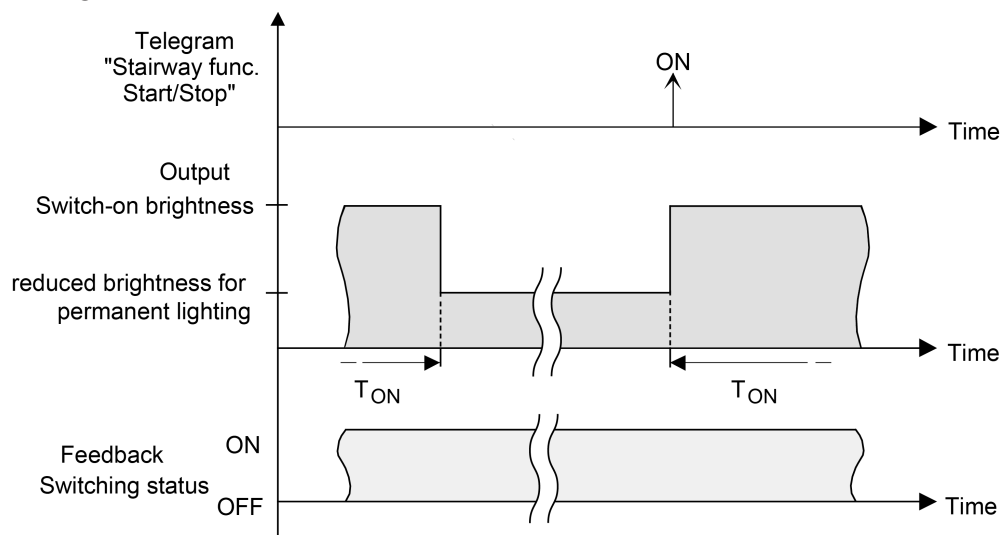

Image 16: The continuous lighting of the staircase function without soft functions

Additionally, the continuous lighting can also be extended by the soft function. Taking into account any soft ON and soft OFF function, this gives rise to modified continuous lighting behaviour of the staircase function.

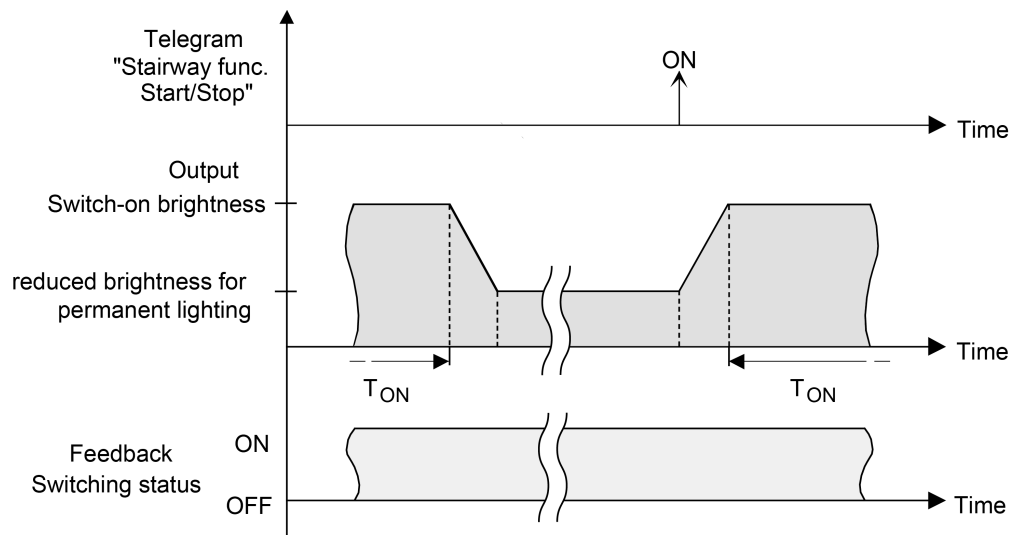

Image 17: The continuous lighting of the staircase function with soft OFF functions

- i** The brightness of the continuous lighting does not necessarily have to be less than the switch-on brightness. The brightness of the continuous lighting can always be configured to values between basic/minimum brightness and maximum brightness.

Precondition:

The staircase function must be enabled on the parameter page "Dimming channel ... -> DO... - General -> Enabled functions".

- on the parameter page "Dimming channel ... -> DO... - General -> Staircase function", set the parameter "At end of the staircase time" to "Activate reduced continuous lighting".

The continuous lighting is enabled. The "Reduced brightness" can be set to the desired brightness value.

- i** The configured value for the reduced brightness must be greater than or equal to the minimum brightness (if configured) or less than or equal to the maximum brightness!
- i** An ON telegram to the object "Staircase function start/stop" while a pre-warning function is still in progress stops the pre-warning time and always restarts the staircase time (independently of the parameter "Staircase time retriggerable"). Even during activated continuous lighting, the parameter "Reaction to OFF telegram" is evaluated so that continuous lighting can be switched off.
- i** Using the automatic switch-off function: The reduced brightness of the continuous lighting does not start the switch-off function after reaching or undershooting the switch-off brightness!

Setting the behaviour of the staircase function after bus voltage return

The staircase function can optionally be started automatically after bus voltage return.

Precondition:

The staircase function must be enabled on the parameter page "Dimming channel ... -> DO... - General -> Enabled functions".

- on the parameter page "Dimming channel ... -> DO... - General", set the parameter "After bus voltage return" to "Activate staircase function".

Immediately after bus voltage return, the staircase time of the staircase function is started.

- i** During automatic starting of the staircase function after bus voltage return, no switch-on delay is started if the staircase function has configured such a delay.
- i** The device only executes the configured "Behaviour on bus voltage return" only if the last ETS programming of the application or of the parameters ended at least approx. 20 s prior to switching on the bus voltage. Otherwise ($T_{ETS} < 20$ s) the behaviour "after ETS programming" will be adopted also in case of bus voltage return.
- i** The configured behaviour will only be executed, if no forced position on bus voltage return is activated.

10.13.1 Staircase function parameters

Dimming channel ... -> DO... - General -> Enabled functions

Staircase function/logic operation function	no selection Staircase function Logic operation function
This parameter determines whether the staircase function or alternatively the logic operation function is available for the dimming channel.	

Dimming channel ... -> DO... - General -> Staircase function

Staircase time	0...23 h 0...3...59 0...59
This parameter is used for programming the duration of the switch-on time for a scene recall.	

Staircase time retriggerable	Checkbox (yes / no)
An active switch-on time can be retriggered (parameter activated). Alternatively, the retriggering time (parameter deactivated) can be suppressed. This parameter is preset to deactivated if the supplementary function "Time extension" is configured. Re-triggering will not be possible.	

Switch-on delay	Checkbox (yes / no)
The staircase function enables the activation of an own switch-on delay. This switch-on delay affects the trigger result of the staircase function and thus delays the switch-on. activated: The switch-on delay for the staircase function is enabled. After reception of an ON telegram on the object "Staircase function start/stop", the switch-on delay is started. Another ON-telegram triggers the time only when the parameter "Switch-on delay retriggerable" is activated. The staircase time is activated and the output is switched on only after the time delay has elapsed. deactivated: The switch-on delay is deactivated. After reception of an ON telegram on the object "Staircase function start/stop", the staircase time is activated immediately and the output switched on.	

Switch-on delay	0...23 h 0...3...59 0...59
This parameter is used for setting the duration of the switch-on delay. Sets the switch-on delay hours.	

Switch-on delay retriggerable	Checkbox (yes / no)
<p>An active switch-on delay can be retriggered (parameter activated). Alternatively, the retriggering time (parameter deactivated) can be suppressed.</p> <p>This parameter is deactivated if the supplementary function "Time extension" is configured. Re-triggering will not be possible.</p> <p>The parameters for the switch-on delay are only visible when the switch-on delay is used.</p>	

Reaction to OFF-telegram	switch off ignore
<p>An active switch-on time can be aborted prematurely by switching off the staircase function.</p> <p>switch off: The switch-on time is aborted after receipt of an OFF telegram on the object "Staircase time start/stop".</p> <p>With the supplementary function "time preset via the bus" and the setting "Staircase function activatable via object 'Staircase time' = activated" the switch-on time can also be prematurely ended by a factor of "0".</p> <p>ignore: OFF Telegrams or "0" factors are ignored. The switch-on time will be executed completely to the end.</p>	

At the end of the staircase time	switch off activate pre-warning time activate reduced continuous lighting
<p>At the end of the staircase time, the actuator for the dimming channel concerned displays the configured behaviour here. The output can be set to switch off immediately or alternatively to execute a pre-warning function.</p> <p>switch off: At the end of the staircase time, the actuator switches off the dimming channel concerned.</p> <p>Activate pre-warning time: At the end of the staircase time, the dimming channel can generate a pre-warning prior to switch-off. The pre-warning, for example, should warn any person still on the staircase that the light will soon be switched off.</p> <p>Activate reduced continuous lighting: At the end of the switch-on time, the actuator activates reduced continuous lighting for the dimming channel concerned. The reduction of the lighting to continuous lighting is appropriate, for example, if a certain degree of artificial light should be switched on permanently in long, dark hallways. Switching to switch-on brightness by activating the staircase function normally takes place by additional presence detectors or motion detectors when people are present in the hallway. The continuous lighting remains permanently active after the switch-on time has elapsed. Only when an ON telegram is received again via the object "Staircase function start/stop" does the actuator switch back to the switch-on brightness and start counting the switch-on time again.</p>	

Pre-warning time	0...59 min 0... 30 ...59 s
------------------	--------------------------------------

This parameter is used for setting the duration of the pre-warning time. The pre-warning time is added to the switch-on time.

Reduced brightness	Basic brightness 5 % ... 50 % ... 100 %
--------------------	---

This parameter defines the reduced brightness that is set either for pre-warning or continuous lighting.

10.13.2 Object list staircase function

Object no.	Function	Name	Type	DPT	Flag
41, 61, 81, 101	Staircase function start/stop	Switching... - Input	1-bit	1,010	C, (R), W, -, A
1-bit object to activate or deactivate the switch-on time of the staircase function of a dimming output ("1" = switch-on / "0" = switch-off).					

10.14 Logic operation function

A logic function can be parameterized separately for each dimming channel. This function allows the logic operation of the "Switching" object state and an additional logic operation object. The state of the communication object for "switching" can also be evaluated with a time delay if a switch-on delay or switch-off delay is set. The logic operation function can also be combined with other functions of a dimming channel. A combination with the staircase function is not possible, however.

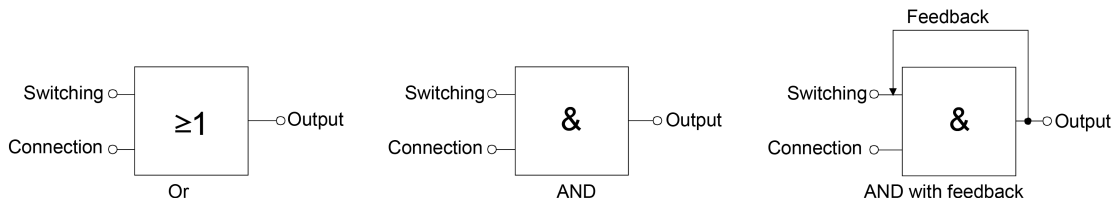

Image 18: Logic operation types of the logic operation function

i "AND with feedback":

With a logic object = "0", the switching output is always "0" (logic AND). In this case, the feedback signal from the output to the "switching" input will directly reset this input when it is being set. The output of the switching output can assume the logical state "1" by a newly received "1" on the input "switching" only when the logic object is = "1".

The object "Logic operation" can be initialised with a configured value after bus voltage return or after an ETS programming operation so that a correct logic operation result can be determined immediately and set on the output during a telegram update on the "Switching" object.

- On the parameter page "Dimming channel ... -> DO... - General -> Enabled functions" activate the "logic operation function".
The logic operation function is enabled. The communication object "logic operation" and the parameters of the logic operation function on the parameter page "Dimming channel ... -> DO... - General -> Logic operation function" become visible.
- Set the parameter "Type of logic operation function" to the desired logic operation type.
- Set the parameters "object value after bus voltage return" and "object value after ETS programming" to the required initial states.

The "logic operation" object is initialised immediately with the set switching states after bus voltage return or ETS programming of the application program or parameters.

i The logic operation function after a reset of the actuator (bus voltage return or ETS programming operation) is first executed when the switching object is updated as the input of the logic operation by at least one telegram.

i The states or switching states specified at the end of a disabling function, which are set after programming in the ETS, in the case of bus voltage failure or after bus or mains voltage return, override the logic operation function. The

configured logic operation is first re-executed and the result set on the switching output when the switching object is updated as the input of the logic operation by at least one telegram.

10.14.1 Logic operation function parameters

Dimming channel ... -> DO... - General -> Enabled functions

Staircase function/logic operation function	no selection Staircase function Logic operation function
The staircase function or the logic operation function or can be enabled or disabled here.	

Dimming channel ... -> DO... - General -> Logic operation function

Type of logic operation function	OR AND AND with feedback
This parameter defines the logical type of the logic operation function. The object "logic operation" is linked to the logic switching state of the dimming channel (object "switching" after evaluation of configured time delays if necessary) using the logic operation function set here. This parameter is only visible when the logic operation function is enabled.	
Object value after bus voltage return	0 (OFF) 1 (ON)
After bus voltage return, the object value of the logic operation object is initialised here with the preset value. This parameter is only visible when the logic operation function is enabled.	
Object value after ETS download	0 (OFF) 1 (ON)
After programming the application or the parameters in the ETS, the object value of the logic operation object is initialised here with the preset value. This parameter is only visible when the logic operation function is enabled.	

10.14.2 Object list logic operation function

Object no.	Function	Name	Type	DPT	Flag
33, 53, 73, 93	Logic operation	Switching... - Input	1-bit	1,002	C, (R), W, -, A
1-bit object for the input of the logical operation of a dimming channel. After bus voltage return or after programming with the ETS, the object value can be pre-defined for each parameter.					

10.15 disabling function

Setting disabling function as supplementary function

During an active disabling function, the KNX control of the dimming function concerned is overridden and locked. Continuous light switching, for example, can also be overridden. The deactivation of the disabling function can optionally take place using an additional 1-bit acknowledgement object. This prevents the deactivation of the disabling function by the disabling object.

- On the parameter page "Dimming channel ... -> DO... - General -> DA... - Enabled functions" activate the parameter "Disabling function".

The disabling function is enabled. The communication object "Disable" and the parameters of the disabling function on the parameter page "Dimming channel ... -> DO... - General -> DA... - Disabling function" become visible.

- Set the parameter "Polarity disabling object" to the desired polarity.
- Set the parameter "Beginning of the disabling function" to the required behaviour.

At the beginning of the disabling function, the configured behaviour will be executed and the bus control of the dimming channel locked.

With the "Switch off" setting, the output is switched off and remains in this state.

With the "Brightness value" setting, the channel sets the specified brightness value and remains in this brightness state.

The "Memory value (brightness value before last switch-off)" setting is used to set the brightness value that was active and internally stored before the last switch-off (via the "Switching" or "Central switching" object). After programming with the ETS, the value is predefined to maximum brightness. Only a bus voltage failure, however, does not delete the memory value.

In the "no reaction" setting, the dimming channel shows no response and remains in the brightness state last selected.

In the "flashing" setting, the dimming channel is switched on and off cyclically during the disabling. The "Time for flashing of the disabling functions" is generally configured on the parameter page "General -> Times". During flashing, the logical switching state of the dimming channel is signalled back as "switched on" and the brightness value as "switch-on brightness". A soft ON/OFF function is not executed during flashing.

Behaviour at the end of disabling ...

The disabling function is deactivated by the disabling object according to the set polarity.

- Set the parameter "End of the disabling function" to the required behaviour.

At the end of the disabling function, the configured behaviour will be executed and the bus control of the dimming channel enabled again.

With the "Switch off" setting, the output is switched off and remains in this state.

With the "Brightness value" setting, the channel sets the specified brightness value.

The "Memory value (brightness value before last switch-off)" setting is used to set the brightness value that was active and internally stored before the last switch-off (via the "Switching" or "Central switching" object). After programming with the ETS, the value is predefined to maximum brightness. Only a bus voltage failure, however, does not delete the memory value.

With "tracked brightness value", the brightness value received during the disabling function or the brightness value set before the disabling function is tracked at the end of disabling. Any time functions still in progress will also be taken into account if necessary.

In the "No reaction" setting, the output shows no reaction and remains in the state last set by the disabling function.

In the "Flashing" setting, the dimming channel is switched on and off cyclically after the disabling. The flashing time is generally configured on the parameter page "General -> Times". During flashing, the logical switching state of the output is fed back as "Switched on". The flashing state remains active until another KNX command is received and thereby predefines another state.

- i** After a bus failure or after programming the application or the parameters with the ETS, the disabling function is always deactivated (object value "0"). With the inverted setting "1 = enabled; 0 = disabled", a telegram update "0" must first be carried out after the initialisation until the disabling is activated.
- i** Updates of the disabling object from "activated" to "deactivated" do not produce a reaction.
- i** A disabled dimming channel can still be operated manually!
- i** In the setting "Set tracked state": During a disabling function, the overridden functions of the actuator (switching, scenes) continue to be executed internally. Consequently, newly received bus telegrams are evaluated and time functions are triggered as well. At the end of the disabling, the tracked states are set.

10.15.1 Disabling function/forced position parameter

Dimming channel ... -> DO... - General -> Enabled functions

disabling function	Checkbox (yes / no)
With this parameter, the disabling function of the device can be activated.	

Dimming channel ... -> DO... - General -> Disabling function

Polarity of the disabling object	0 = disabled; 1 = enabled 1 = enabled; 0 = disabled
<p>This parameter defines the polarity of the disabling object. This parameter is visible only if the disabling function is enabled.</p>	
Beginning of the disabling function	switch off brightness value Memory value (brightn. bef. switch. off last time) no reaction flashing
<p>The behaviour of the dimming output at the beginning of the disabling function can be configured. This parameter is visible only if the disabling function is enabled.</p> <p>Switch off: At the start of the disabling function, the dimming output is switched off and locked.</p> <p>Brightness value: At the start of the disabling function, the dimming channel is set to the predefined brightness value and locked.</p> <p>Memory value: At the start of the disabling function, the active and internally saved value prior to the last switch-off is set (via the "Switching" or "Central switching" object).</p> <p>No reaction: At the start of a disabling function, the dimming channel shows no reaction and remains in the currently set state. Bus control of the dimming channel is then locked.</p> <p>Switch on: At the start of the disabling function, the dimming channel is switched on and locked.</p> <p>Flashing: The dimming channel flashes on and off during the disabling function and the bus control is locked during this time. The flashing time is configured generally for all channels on the parameter page "General". During the flashing, the logical switching state is "on 1" and the switch-on brightness is signalled back as brightness. A soft ON/OFF function is ignored during flashing.</p>	

End of the disabling function	switch off brightness value Memory value (brightn. bef. switch. off last time) tracked brightness value no reaction flashing
<p>The behaviour of the dimming output at the end of the disabling function can be configured.</p> <p>This parameter is visible only if the disabling function is enabled and acknowledgement is not used.</p> <p>Switch off: At the end of the disabling function, the dimming output is switched off and enabled again.</p> <p>Brightness value: At the end of the disabling function, the dimming channel is set to the predefined brightness value and enabled again.</p> <p>Memory value: At the end of disabling, the active and internally stored brightness value prior to the last switch-off is set (via the "Switching" or "Central switching" object).</p> <p>tracked brightness value: At the end of the disabling function, the state received during the disabling function or the state set before the disabling function is tracked with the appropriate brightness value. Any time functions still in progress will also be taken into account if necessary.</p> <p>No reaction: At the end of a disabling function, the dimming channel shows no reaction and remains in the currently set state. Bus control of the dimming channel is enabled again.</p> <p>Flashing: The dimming channel is enabled again for the bus control after the end of the disabling function and flashes on and off. The flashing time is configured generally for all channels on the parameter page "General". During the flashing, the logical switching state is "on 1" and the switch-on brightness is signalled back as brightness. A soft ON/OFF function is ignored during flashing. The flashing status remains active until another bus command is received and specifies another status.</p>	

10.15.2 Disabling function/forced position object list

Object no.	Function	Name	Type	DPT	Flag
39, 59, 79, 99	Disabling	Dimming channel ... - Input	1-bit	1,003	C, (R), W, -, A
1-bit object for disabling a dimming channel (polarity configurable).					

11 As-delivered state

In the as-delivered state, the actuator is passive, i.e. no telegrams are transmitted to the KNX. All dimming channels are set to the universal dimming principle with automatic recognition of the load type. The outputs can, however, be activated by manual operation on the device, if the bus voltage is on. With manual operation, no feedback telegrams are sent to the KNX.

The device can be programmed and put into operation via the ETS. The physical address is preset to 15.15.255

Moreover the device has been configured at the factory with the following characteristics...

- Behaviour in case of bus voltage failure: no reaction
- Behaviour in case of bus voltage return: brightness before bus voltage failure
- Status indication: permanent

i The as-delivered state cannot be restored by unloading the application program with the aid of the ETS. When the application program is removed, all the outputs remain permanently switched off. The manual operation remains without function in this case.

Gira
Giersiepen GmbH & Co. KG
Elektro-Installations-
Systeme

Industriegebiet Mermbach
Dahlienstraße
42477 Radevormwald

Postfach 12 20
42461 Radevormwald

Deutschland

Tel +49(0)21 95 - 602-0
Fax +49(0)21 95 - 602-191

www.gira.de
info@gira.de