

Installation and  
operating manual

**Energy Profile**

1341 26/28

**Energy Profile with lighting element**

1342 26/28

**Light Profile**

1343 26/28

**Light Profile, small**

1344 26/28

**GIRA**

## Table of contents

Description .....	2
Construction .....	2
Energy Profile installation .....	3
Using a soil tube .....	3
Direct screw fitting .....	4
Connecting the wiring .....	4
Installing and replacing lamps .....	5
Installation of slats element .....	5
Empty connection units .....	6
Specifications .....	7
Lighting range .....	7
Manufacturer's warranty .....	7

## Description

The Energy Profile is made from painted aluminium and designed for outdoor use in domestic applications to provide electrical power and area or orientation lighting.

Various types of connectors and switches can also be integrated into Energy Profiles, such as telephone and loudspeaker sockets or light switches.

Gira Energy Profiles are available in four different models in the colours anthracite grey and aluminium:

- Energy Profile with three SCHUKO socket outlets  
Order no. 1341 26/28
- Energy Profile with a lighting element with empty unit and two SCHUKO socket outlets  
Order no. 1342 26/28
- Light Profile (height: 769 mm)  
Order no. 1343 26/28
- Small Light Profile (height: 491 mm)  
Order no. 1344 26/28

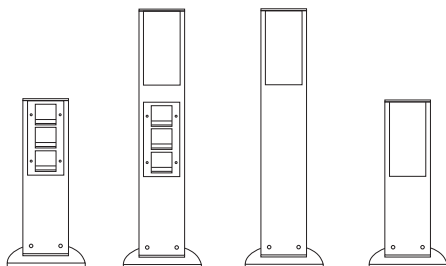

## Construction

The basic construction of an Energy Profile with lighting element is illustrated here:

- (1) top cover
- (2) lighting element with light panel
- (3) connection unit with TX\_44 switch plate
- (4) profile
- (5) profile base

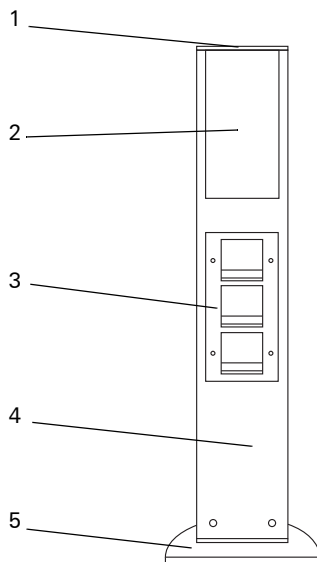

### Maintenance instructions

Please clean your Energy Profile using only soapy water or a solvent-free, non-foaming cleaning agent.

## Energy Profile installation



### Condensation opening

Before installing the Energy Profile, open the condensation exit on the bottom of the profile base. To do so, break out the tab for the opening and remove any rough edges using a file.

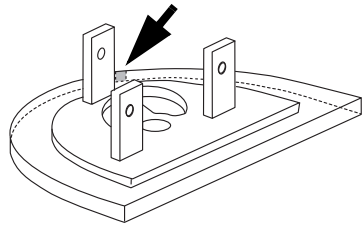

The Energy Profile can be fitted with just one screw. Depending on the conditions of the underlying surface, there are two different options for anchoring the Energy Profile to the ground.

### Using a soil tube

On loose or soft subsoil, such as a flower bed or lawn, install the Energy Profile using a soil tube. Please proceed as follows:

1. Dig a hole (of approximately 50 cm) at the location where you wish to install the profile.
2. Feed the lead-in cables (i.e. power cables and telephone or loudspeaker cables) through the tube.
3. Fill the excavated hole with concrete and place the tube upright in the hole.
4. Feed the lead-in cables through the profile base.
5. Fasten the profile base to the tube using the provided hexalon-head screw.
6. Connect the Energy Profile wiring (see Seite 4).
7. Connect the earth lead of the Energy Profile to the earth terminal on the profile base.
8. Place the Energy Profile on the profile base and fasten it in place using the three Allen screws.

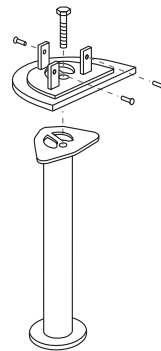

### Positioning the soil tube

When cementing the soil tube in place, bear in mind the desired position of the Energy Profile. The Energy Profile can be rotated around the axis of the soil tube by up to 20 degrees to adjust its orientation.

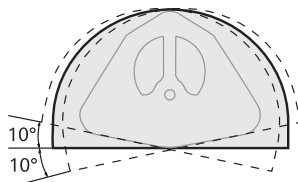

## Connecting the wiring

### Direct screw fitting

On a firm underlying surface, such as brick, concrete or asphalt, the Energy Profile can be installed directly on the ground.

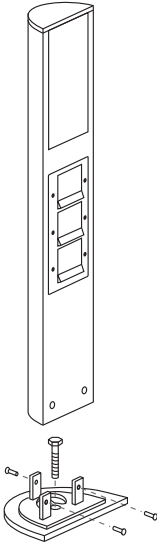

Please proceed as follows:

1. Drill a hole where you want to install the profile and insert the supplied plug.
2. Feed the lead-in cables (mains power cable and telephone or loudspeaker cable, if applicable) through the profile base.
3. Fasten the profile base to the ground using the provided hexagon-head screw.
4. Connect the Energy Profile (see Seite 4).
5. Connect the earth wire of the Energy Profile to the earth terminal on the profile base.
6. Place the Energy Profile on the profile base and fasten it using the three Allen screws.



### Note!

The installation and assembly of electrical equipment may only be performed by a qualified electrician.

The Energy Profile's lighting element and socket outlets are pre-wired up to the connection terminals.

Proceed as follows to connect the Energy Profile to the mains circuit:

1. Remove the terminal box from the bottom opening of the Energy Profile and open it.
2. The connection of the terminals depends on the Energy Profile model.

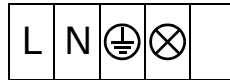

For Energy Profiles with connection unit, connect the power cable for the socket outlets to the L/N/⊕ terminals.

For Energy Profiles with a lighting element, the lighting is connected via the ⊗/N/⊕ terminals.

3. The free and unlabeled terminals can be used for wiring the empty unit.
4. Close the terminal box and slide it back into the Energy Profile.
5. Connect the Energy Profile earth lead to the earth terminal on the profile base.

## Installing and replacing lamps

Light sources with E27 threading of the energy efficiency classes A++ to E can be used.

In order to install or replace the lamp, please proceed as follows:

1. Remove the screws from the top cover and remove the top cover from the profile.
2. Pull the light panel upwards, sliding it out of the profile.
3. Place the lamp in the fitting.
4. Place the light panel by sliding it in the profile from the top (pay attention to 'TOP FRONT' indication).
5. Place the top cover and fasten with the screws.



### Lamp diameter

Lamps with a base diameter of up to 52 mm can be used in the Energy Profile.

If a slats element is used, the maximum base diameter is reduced to 48 mm!

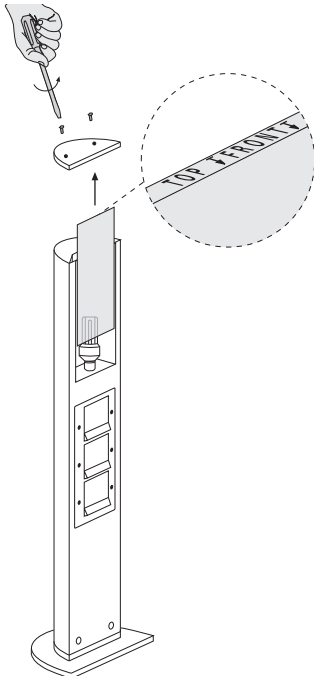

## Installation of slats element

An optional slats element can be used in order to focus the Energy Profile lighting element on objects or paths.

To fit the slats element and the accompanying transparent light panel, please proceed as follows:

1. Remove the screws from the top cover and remove the top cover from the profile.
2. Pull the light panel upwards, sliding it out of the profile.
3. Place the transparent panel by sliding it in the profile from the top (pay attention to the 'TOP FRONT' indication).
4. Fit the slats element: with the slats directed upward for object lighting, for example.

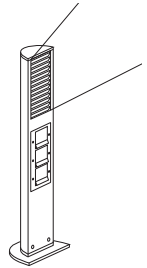

with the slats directed downward for path lighting, for example.

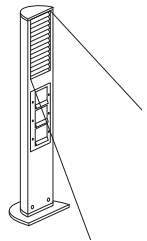

5. Place the top cover and fasten it with the screws.



### Transparent panel / light panel

The slats element can be used with either a transparent panel or a satinised light panel.

## Empty connection units

Energy Profiles with lighting elements have one empty unit that can be individually fitted. This empty unit is provided with an intermediate plate and spring cover suitable for integrating System 55 base elements.

Please proceed as follows to fit a new base element:

1. Remove the Torx screws securing the three-fold switch plate and remove the switch plate by inserting the tip of a screwdriver under the lower corner and levering up the switch plate.
2. Remove the intermediate plate with spring cover.
3. Using a screwdriver, prise the blind panel free of the empty unit. Remove the screws from the wall socket's base elements and remove the base elements.
4. Remove the frame base.
5. Replace the blind panel supporting ring with a new built-in base element.
6. Position the frame base.
7. Install the base elements and tighten with screws if necessary.
8. Fit the intermediate plates with spring cover.
9. Click the switch plate firmly into place and insert the Torx screws.

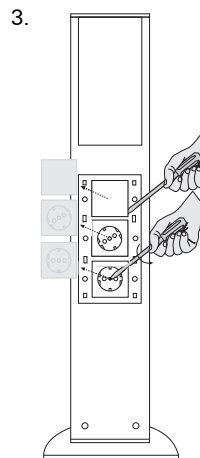
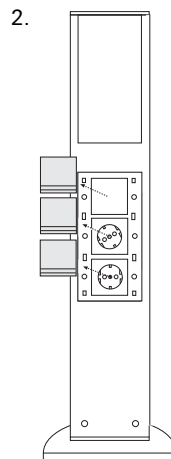
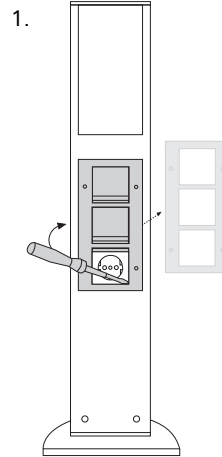

### Integration of System 55 base elements

Certain System 55 base elements require a different intermediate plate and spring cover from the TX\_44 range. An overview of which base elements can be combined with which intermediate plates is provided in the Gira catalogue.

## Specifications

Dimensions (W x H x D):	
Profile base:	229 x 10 x 155 mm
Small profile:	142 x 491 x 75 mm
Large profile:	142 x 769 x 75 mm
Protection:	IP 44 with covers closed
Connections:	Screw clamps, 1 x 4 mm <sup>2</sup> or 2 x 2.5 mm <sup>2</sup>
Lamp:	Light sources with E27 treading of the energy efficiency classes A++ to E
Power:	21 W max.
Diameter:	52 mm max. 48 mm max. (if slats element is used)

## Warranty

The warranty is provided in accordance with statutory requirements via the specialist trade.

Please submit or send faulty devices postage paid together with an error description to your responsible salesperson (specialist trade/installation company/electrical specialist trade).

They will forward the devices to the Gira Service Center.

## Lighting range

Large Light Profile, satinised light panel,

20 W lamp

Hight of point of light above ground: 0,65 m

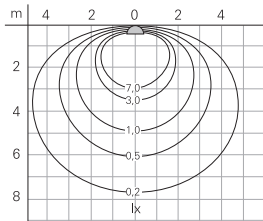

Small Light Profile, satinised light panel,

20 W lamp

Hight of point of light above ground: 0,363 m

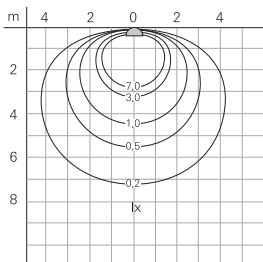

Gira  
Giersiepen GmbH & Co. KG  
Electrical installation  
systems  
Industriegebiet Mermbach  
Dahlienstraße  
42477 Radevormwald  
P.O. Box 12 20  
42461 Radevormwald  
Germany  
Phone+49 (0) 2195 602 - 0  
Fax +49 (0) 2195 602 - 191  
[www.gira.com](http://www.gira.com)  
[info@gira.com](mailto:info@gira.com)

10866537 49/19

# GIRA

