



Product name:	<b>Switching actuator 16fold / blind/shutter actuator 8fold</b>
Design:	DIN rail mounting device
Item no.:	<b>1029 00</b>
ETS search path:	Gira Giersiepen / output / Binary output mix / switching act. 16fold / shutter act. 8fold 10A DRA

#### Functional description:

Depending on parameterization, the actuator works as switching actuator with max. 16 outputs or as blind/shutter actuator with max. 8 outputs. In the "shutter" mode, the actuator can also control rolling shutters. The functions can also be mixed so that the actuator can switch lamps and control shutter motors via different outputs (e.g. outputs A1 – A6 as 6-channel switching actuator, outputs A7 – A14 as 4-channel blind/shutter actuator, outputs A15 – A16 as 2-channel switching actuator). In this case, two output channels per motor must be combined for the blind/shutter function (cf. connection diagram).

The actuator is equipped for manual control permitting continuous or temporary control of the individual outputs independent of the bus. Mains supply is required.

A safety function for blind/shutter applications offers the possibility of setting all affected outputs in the event of a storm warning to a predefined safety position and to lock them in this position. Up to two sun protection functions permit controlling the shutter outputs depending on lighting conditions. An inhibit function can be used to lock up parameterized switching outputs. A central function (1 bit or 2 bits) permits setting the switching outputs alternatively to a predefined position.

#### Illustration:

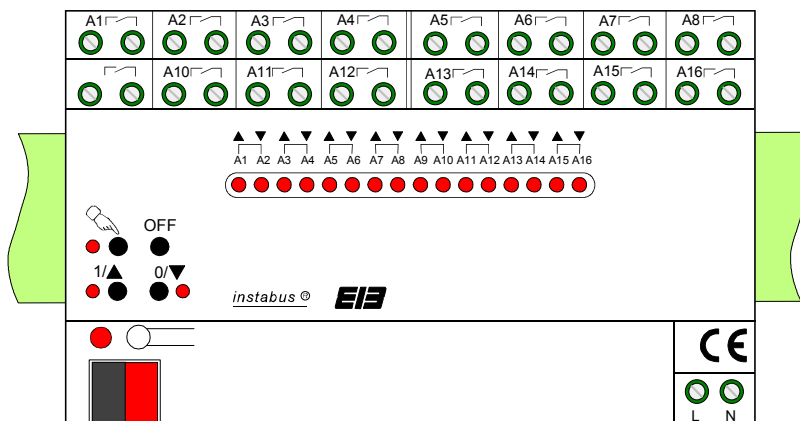

#### Dimensions:

Width: 8 PU; 144 mm

Height: 90 mm

Depth: 64 mm

PU = partial unit

#### Controls:

- 1 programming key
- 1 programming LED (red)

#### Manual controls:

- 1 " " key for manual control enable (select key)
- 1 "OFF" key for All-OFF / All-STOP
- 1 "1 / ▲" key for switching on resp. for upward movement
- 1 "0 / ▼" key for switching off resp. for downward movement

#### Status indicators:

16 LEDs (red) for the indication of switching status resp. movement direction of the individual outputs. The LEDs are lit up when the switching contacts of the relays are closed.

1 LED (red) for status indication "permanent manual control mode".

1 LED (red) for indication of switching status "ON" resp. movement direction "UP" of the selected output during manual control.

1 LED (red) for indication of switching status "OFF" resp. movement direction "DOWN" of the selected output during manual control.

# instabus EIB System

## Actuator

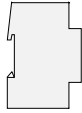

---

### Specifications:

#### External supply

Voltage:	110 V (-10 %) - 240 V (+10 %) AC; 50 / 60 Hz (no DC)
Total power dissipation:	max. 5,5 W
Connection:	Screw terminals:
	0.5 – 4 mm <sup>2</sup> single wire and stranded without ferrule
	0.5 – 2.5 mm <sup>2</sup> stranded wire with ferrule

#### instabus EIB supply

Voltage:	21 – 32 V DC (SELV)
Power consumption:	max. 150 mW
Connection:	instabus connecting and branching terminal

---

#### Input

---

---

#### Output

Number:	16 (max. 16 switching outputs / max. 8 blind/shutter outputs)
Switching contact type:	normally open, floating ( $\mu$ -contact)
Switching voltage:	250 V AC 50-60 Hz (no DC)
Max. switching current:	10 A at 250 V AC
Switching capability	
Incandescent lamps:	1400 W
HV halogen lamps:	1225 W
LV halogen lamps	
inductive transformers:	1200 VA
electronic transformers:	1200 W
Fluorescent lamps compensated:	not approved
Motors:	600 W (no three-phase motors)
Connection:	Screw terminals:
	0.5 – 4 mm <sup>2</sup> single wire and stranded without ferrule
	0.5 – 2.5 mm <sup>2</sup> stranded wire with ferrule

---

Degree of protection:	IP 20
Mark of approval:	EIB
Ambient temperature:	-5 °C ... +45 °C
Storage temperature:	-25 °C ... +70 °C (reduced lifetime when stored above +45 °C)
Fitting position:	any
Minimum distances:	none
Type of fixing:	Snap-fastening on DIN rail (no data rail required)



Response to voltage failure	(see also "Bus and mains voltage", page 16)
Bus voltage only:	Parameter-dependent ("response to bus voltage failure" per output)
Mains voltage only:	All outputs switch off or stop. Manual control not possible. The safety function and the central function (only with 2-bit "priority control") remain active if activated before. Sun protection or inhibit function are always rejected.
Bus and mains voltage:	All outputs switch off or stop. Manual control not possible. Safety, sun protection, central or inhibit functions are rejected.
Response on reactivation	(see also "Bus and mains voltage", page 16)
Bus voltage only:	Mains voltage not available: Outputs are off and/or stopped. Bus communication is possible, i.e. the safety function can be activated. Updates of the sun protection, inhibit or central functions or updates on the short (Step) / long (Move) objects or the switching objects during mains failure are rejected.  Mains voltage available: Parameter-dependent ("response on return of bus voltage" per output)
Mains voltage:	Bus voltage not available: Parameter-dependent ("response to bus voltage failure" per output) Manual control is possible.  Bus voltage available: For blind/shutter operation: parameter-dependent ("response on return of bus voltage" per output). For switching operation: switching status before mains failure will be restored.  Manual control is possible.
	Exceptions:
	<ol style="list-style-type: none"> <li>1. In the blind/shutter mode, the actuator automatically reactivates the safety function for the outputs assigned, if the safety object has been activated before or during the mains failure. The parameterized "response at the beginning of the safety function" is then repeated. A safety function activated before and deactivated during the mains failure launches a new movement as parameterized for "end of the safety function" on return of the mains voltage. If a safety function was at first activated and then deactivated again during the mains failure, the actuator does not, after return of the mains, launch a new movement for the outputs assigned. In any case, the outputs assigned are re-enabled after safety deactivation. The sun protection functions are deactivated.</li> <li>2. In the switching mode, the actuator automatically reactivates the central function (only with 2-bit "priority control"), if priority control was activated before the mains failure. Deactivation of priority control during mains failure is then not possible. The inhibit function is deactivated, i.e. the switching channels are enabled.</li> </ol>
Bus and mains voltage:	Parameter-dependent ("response on return of bus voltage" per output) (cf. "Bus voltage only" / "Mains voltage only")

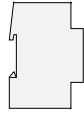

### Connection diagram / Assignment of terminals:

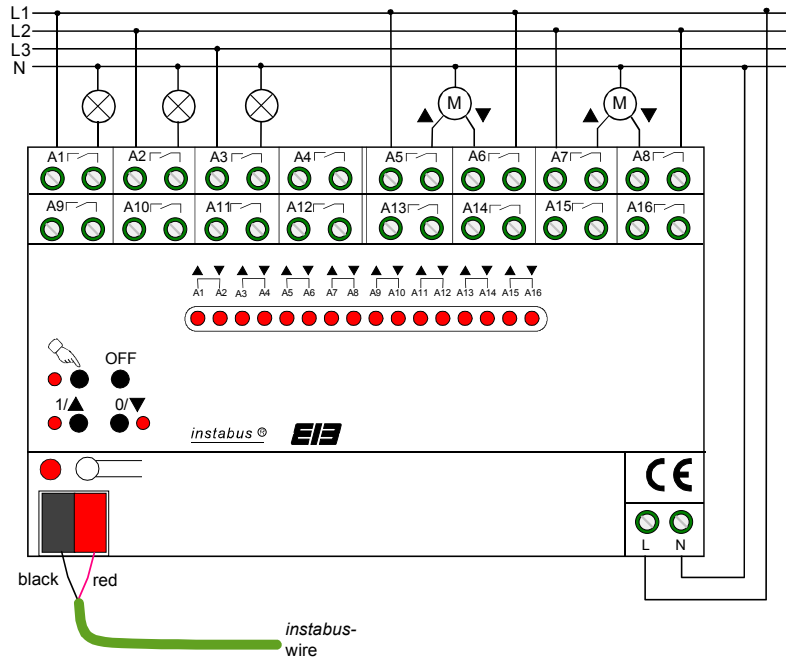

The mains voltage and the loads are connected as shown in the diagram above. The example shows connection of 3 lamps to outputs A 1 – A3 and 2 blind/shutter motors to outputs A5/A6 and A7/A8. Further loads are connected in the same way.

For blind/shutter operation, two neighbouring relay outputs are grouped to form an output channel. The relay output on the left (1, 3, 5, ...) respectively is the one for the UP movement whereas the one on the right (2, 4, 6, ...) is responsible for the DOWN movement.

#### Important information:

It must be ensured that the loads connected are compatible with the parameterization of the outputs. There is otherwise a risk of irreparable damage to blind/shutter motors, if they are connected to outputs parameterized as switching actuator outputs. For this reason, the loads connected must be checked before programming the device with the ETS. The movement directions in blind/shutter operation are interlocked only by the software.

#### Hardware information:

- Connection of different phase conductors is possible.
- Connecting 230 V and SELV to different outputs of the actuator is not permitted.
- The supply voltage (mains voltage) is connected to terminals "L" and "N". The relays can only be operated when the mains voltage is on.
- If, motors are to be connected in parallel to the outputs in blind/shutter operation, it is absolutely indispensable to observe the corresponding instructions of the motor manufacturers to avoid irreparable damage to the motors. If necessary, use supplementary isolating relays.
- For blind/shutter operation, use only blinds or shutters with end position limit switches (mechanical or electronic). The limit switches of the motors connected are to be checked for correct adjustment.
- Activation of the manual operating mode stops all blind/shutter output channels. The switching channels maintain their status. In this case, bus communication has no longer any effect on the relay switching condition. Safety interlock, sun protection and inhibit function, the central function and all time functions will be aborted. A safety function will be subsequently executed on leaving the manual control mode, if still active, and a priority control that was active beforehand will also be reactivated (switching channels disabled). In the manual control mode with blind/shutters, only long operation (long depression of key) and the stop command (brief depression of key) are available.

**Software description:**

ETS search path:

Gira Giersiepen / output / Binary output mix / switching act. 16fold / shutter act. 8fold 10A DRA

ETS-symbol:

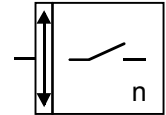
**Applications:**

Brief description:

switching / shutter and blinds

Name:

switching, time func. / shutter 802602

Date:

09.03

Page:

7

Data base

2.53

**instabus EIB System**

**Actuator**

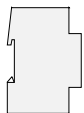



---

**Application:** **switching, time func. / shutter 802602**

---

**Scope of functions**

- Max. 16 switching outputs or max. 8 blind/shutter outputs. The 8 pairs of outputs can be freely assigned to the "Switching" or "blind/shutter" functions.
- Switching status indication for each relay output (LED lit up = contact closed),
- Manual control of all output channels possible even without bus voltage. Manual control can be inhibited.

Switching function:

- Inhibit function possible (response at the beginning and at the end of inhibit is parameterizable),
- Central function possible, alternatively for common switching (EIS 1) or as priority control (EIS 2),
- Relay operation presettable (breaking contact / making contact),
- Time function possible for outputs A1 thru A8 (OFF-delay or timer function / for timer function, the response to an OFF-telegram can be parameterized),
- Response to failure and return of bus voltage adjustable

Blind/shutter function:

- Blind/shutter presettable: Venetian blind (with slat position control) or rolling shutter,
- Moving times for short and long operation presettable (1 x for all blind/shutter outputs),
- Break during change of moving direction (change-over time) parameterizable (1 x for all blind/shutter outputs),
- Response to failure and return of bus voltage adjustable,
- Safety function, e.g. for wind alarm, with or without cyclical monitoring, with movement to one of the limit positions or no reaction parameterizable (polarity of safety object adjustable),
- Up to 2 sun protection functions for assignable blind / shutter outputs (separate moving times for sun protection activation parameterizable; sun protection positioning including slat position control possible; response at the end of the sun protection cycle selectable).

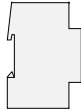

### Object description (dynamic object structure):

0 - 16	<b>Switching (EIS 1):</b>	1-bit object for switching of a switching output The switching status is dependent on relay operation: "making": "1" = contact closed / "0" = contact open. "breaking": "1" = contact open / "0" = contact closed. The status indicator LEDs of the LED array on the device are lit up when the switching contacts are closed.
0, 2, 4...14	<b>Short operation (Step) (EIS 7):</b>	1-bit object for short operation (step) of a blind/shutter
1, 3, 5...15	<b>Long operation (Move) (EIS 7):</b>	1-bit object for short operation (move) of a blind/shutter
16	<b>Switching (EIS 1):</b>	1-bit object for central switching of all switching outputs integrated in the central function (parameterizable). The switching status is dependent on relay operation: "making": "1" = contact closed / "0" = contact open. "breaking": "1" = contact open / "0" = contact closed.
16	<b>Priority control (EIS 8):</b>	2-object for priority control of all switching outputs integrated in the central function (parameterizable). The switching status is dependent on relay operation: "Making": "priority control on / on" = contact closed / "priority control off / off" = contact open "Breaking": "priority control on / on" = contact open / "priority control off / off" = contact closed.
17	<b>Sun protection 1 (EIS 1):</b>	1-bit object for activation of sun protection function 1. "1": sun protection activated / "0": sun protection deactivated.
18	<b>Sun protection 2 (EIS 1):</b>	1-bit object for activation of sun protection function 2. "1" = sun protection activated / "0" = sun protection deactivated.
18	<b>Inhibit (EIS 1):</b>	1-bit object for inhibition of all switching channels integrated in the inhibit function (parameterizable). "1" = inhibit function activated / "0" = inhibit function deactivated.
19	<b>Safety (EIS 1):</b>	1-bit object for reception of an alarm resp. safety message (polarity parameterizable)





Number of addresses (max.):	32	dynamic table management:	Yes <input checked="" type="checkbox"/>	No <input type="checkbox"/>
Number of assignments (max.):	32	maximum table length:	64	

Communication objects: 20

Object:	Function:	Name:	Type:	Flag:
Function: 2 x switching" (for all 8 pairs of outputs)*				
<input type="checkbox"/> ← 0	switching	output 1	1 Bit	S,K,(L)**
<input type="checkbox"/> ← 1	switching	output 2	1 Bit	S,K,(L)**
<input type="checkbox"/> ← 2	switching	output 3	1 Bit	S,K,(L)**
<input type="checkbox"/> ← 3	switching	output 4	1 Bit	S,K,(L)**
<input type="checkbox"/> ← 4	switching	output 5	1 Bit	S,K,(L)**
<input type="checkbox"/> ← 5	switching	output 6	1 Bit	S,K,(L)**
<input type="checkbox"/> ← 6	switching	output 7	1 Bit	S,K,(L)**
<input type="checkbox"/> ← 7	switching	output 8	1 Bit	S,K,(L)**
<input type="checkbox"/> ← 8	switching	output 9	1 Bit	S,K,(L)**
<input type="checkbox"/> ← 9	switching	output 10	1 Bit	S,K,(L)**
<input type="checkbox"/> ← 10	switching	output 11	1 Bit	S,K,(L)**
<input type="checkbox"/> ← 11	switching	output 12	1 Bit	S,K,(L)**
<input type="checkbox"/> ← 12	switching	output 13	1 Bit	S,K,(L)**
<input type="checkbox"/> ← 13	switching	output 14	1 Bit	S,K,(L)**
<input type="checkbox"/> ← 14	switching	output 15	1 Bit	S,K,(L)**
<input type="checkbox"/> ← 15	switching	output 16	1 Bit	S,K,(L)**

Function: 1 x blind/shutter (for all 8 pairs of outputs)\*

<input type="checkbox"/> ← 0	short operation (Step)	output 1/2	1 Bit	S,K,(L)**
<input type="checkbox"/> ← 1	long operation (Move)	output 1/2	1 Bit	S,K,(L)**
<input type="checkbox"/> ← 2	short operation (Step)	output 3/4	1 Bit	S,K,(L)**
<input type="checkbox"/> ← 3	long operation (Move)	output 3/4	1 Bit	S,K,(L)**
<input type="checkbox"/> ← 4	short operation (Step)	output 5/6	1 Bit	S,K,(L)**
<input type="checkbox"/> ← 5	long operation (Move)	output 5/6	1 Bit	S,K,(L)**
<input type="checkbox"/> ← 6	short operation (Step)	output 7/8	1 Bit	S,K,(L)**
<input type="checkbox"/> ← 7	long operation (Move)	output 7/8	1 Bit	S,K,(L)**
<input type="checkbox"/> ← 8	short operation (Step)	output 9/10	1 Bit	S,K,(L)**
<input type="checkbox"/> ← 9	long operation (Move)	output 9/10	1 Bit	S,K,(L)**
<input type="checkbox"/> ← 10	short operation (Step)	output 11/12	1 Bit	S,K,(L)**
<input type="checkbox"/> ← 11	long operation (Move)	output 11/12	1 Bit	S,K,(L)**
<input type="checkbox"/> ← 12	short operation (Step)	output 13/14	1 Bit	S,K,(L)**
<input type="checkbox"/> ← 13	long operation (Move)	output 13/14	1 Bit	S,K,(L)**
<input type="checkbox"/> ← 14	short operation (Step)	output 15/16	1 Bit	S,K,(L)**
<input type="checkbox"/> ← 15	long operation (Move)	output 15/16	1 Bit	S,K,(L)**

\* The "2 x switching" resp. "1 x blind/shutter" functions can be parameterized for the 8 pairs of outputs. The parameter and object structure will therefore vary depending on parametrization.

\*\* For objects marked (L), the object status can be read out (set "L" flag!). The status set by manual control or by means of an inhibit function for switching channels will not be retained in the "switching" objects! Switching conditions caused by a time or central function (only 1-bit central function) will be retained. No status will be retained for the blind/shutter outputs in the Step resp. in the Move objects!

# instabus EIB System

## Actuator

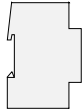

Object:	Function:	Name:	Type:	Flag:
Function: Switching (1 bit) ***				
□← 16	Central function (switching)	switching	1 Bit	S,K,(L)**
Function: Priority control (2 bits) ***				
□← 16	Central function (switching)	priority control	2 Bit	S,K,(L)**
Function: Sun protection function 1				
□← 17	Sun protection function (blind/shutter)	sun protection 1	1 Bit	S,K,(L)**
Function: Inhibit function***				
□← 18	Auxiliary function (switching)	inhibit	1 Bit	S,K,(L)**
Function: Sun protection function 2 ***				
□← 18	Auxiliary function (blind/shutter)	sun protection 2	1 Bit	S,K,(L)**
Function: Safety				
□← 19	Auxiliary function (blind/shutter)	safety	1 Bit	S,K,(L)**

- \* The "2 x switching" resp. "1 x blind/shutter" functions can be parameterized for the 8 pairs of outputs. The parameter and object structure will therefore vary depending on parameterization.
- \*\* For objects marked (L), the object status can be read out (set "L" flag!). The status set by manual control or by means of an inhibit function for switching channels will not be retained in the "switching" objects! Switching conditions caused by a time or central function (only 1-bit central function) will be retained. No status will be retained for the blind/shutter outputs in the Step resp. in the Move objects!
- \*\*\* Depending on parameterization, the objects for the central and auxiliary function will be created dynamically.



## Description of functions

The actuator is equipped with a safety function that can be separately assigned to the blind or shutter channels. The safety function can be activated or deactivated by means of an object. The polarity of the object can be parameterized.

### Safety reaction

Only the output channels to which the safety function has been assigned show a reaction! The response of the channels at the beginning and at the end of a safety function can be generally preselected.

"Response at the start a safety function":

The actuator moves the blinds/shutters optionally into one of the limit-stop positions, if the response to safety is parameterized for "moving UP" or "moving DOWN". With these settings, the blinds/shutters will be locked up in the limit position after the end of the safety movement. If the response to safety is parameterized for "no reaction", no movement will be started and the output channels locked up in the current position.

With respect to other bus-controllable functions of the blind/shutter channels, the safety function has the highest priority. This means that all active functions of the outputs concerned as, for instance, an active sun protection function or short (Step) or long (Move) commands will be aborted and the safety function executed. The safety function can only be interrupted by manual control of the device.

"Response at the end a safety function":

If parameterized for "UP movement" or "DOWN movement", the output channels concerned are immediately re-enabled by the actuator at the end of the safety function and the blind/shutter is moved into the corresponding limit positions. If the response at the end of a safety function is parameterized for "no reaction", the corresponding outputs are re-enabled without, however, launching a new movement. If the outputs are re-enabled for "no reaction" while a safety movement is still in progress, the outputs will be re-enabled without stopping the movement.

A sun protection function interrupted by a safety function will not be continued after safety deactivation.

### Cyclical monitoring

The safety object can be cyclically monitored for the reception of telegrams.

When monitoring is enabled (monitoring time parameterized), the actuator expects a telegram update to the safety object! If no telegrams are received during the monitoring time, the safety function will be activated.

The safety function can be deactivated again when a safety unlock command is received.

The cycle time of the transmitters should be shorter than the monitoring time parameterized in the blind/shutter actuator in order to ensure that at least one telegram can be received during the monitoring time.

### Manual control and safety function

With respect to all other bus-controllable blind/shutter functions, the safety function has the highest priority. The safety function can be interrupted only by manual control of the device.

After the end of manual control, the actuator automatically reactivates the safety function for the blind/shutter outputs assigned, if the safety object has been activated before or during manual control and re-executes the parameterized "response at the beginning of a safety function".

A safety function activated before and deactivated during manual control causes the actuator to start a new movement after deactivation as parameterized for "end of safety function". If a safety function has been activated and then deactivated during manual control, the actuator does not start a new movement for the outputs assigned after deactivation of the manual control mode. The blind/shutter outputs concerned are in any case re-enabled after safety deactivation.

## instabus EIB System

### Actuator

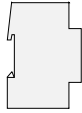

#### Remarks on safety function:

- The time of a safety movement to limit position for a blind/shutter output is determined by the "long operation" parameter on the "Movement time" card. Safety movements are not retriggerable.
- After a movement to the limit stop positions at the beginning or at the end of a safety function (response type: "UP movement" or "DOWN movement") the slats of a blind are not readjusted. After an "UP movement", the slats are completely open (0 %) and after a "DOWN movement" they are completely closed (100 %).
- On return of bus voltage, the safety function is always deactivated. In the event of a safety interlock with an object value of "0", an object update must occur after return of bus voltage ("0" telegram) before the safety function is activated again.
- An object update of the safety object ("activating" after "activating" resp. "deactivating" after "deactivating") shows no reaction.
- The safety function interrupts the sun protection function and all other bus-controlled movements of the blind or shutter. A safety-locked output cannot be influenced by a sun protection function. A sun protection function can be active again only after deactivation of the safety lock and a new telegram update of the sun protection object and, if necessary, on the enabled output. Long (Move) or short (Step) commands during an activated safety function will be rejected.

### Sun protection function

The actuator has up to two sun protection functions for separate assignment to the blind or shutter channels. The sun protection functions can be activated resp. deactivated via separate objects. The second sun protection function can be enabled by the auxiliary function as an alternative to the inhibit function for switching channels. Only one sun protection function can be assigned to a blind or shutter output. It is not possible to combine the two automatic sun protection functions.

#### Sun protection behaviour / sun protection positioning

The response of the blind/shutter outputs assigned at the beginning and at the end of a sun protection function can be predetermined.

Response at the beginning of a sun protection function:

The sun protection function is executed in three steps:

1. Reference movement into the upper end position only if the blind or shutter is not already in its upper end position (long upward movement ended.)  
A reference movement is executed in the form of the parameterized long movement (long operation).
2. Positioning of the blind / shutter: During the sun protection movement time separately preset for both sun protection functions ("Long operation" in acc. with "Sun protection" card), the blind or shutter is moved downwards. When the sun protection movement time elapses, the blind or the shutter will stop in sun protection position.
3. Positioning of the slats: positioning of the slats in acc. with the parameterized "Number of steps after long-step operation" will be effected after the sun protection movement only for such outputs for which the "Blind/shutter type" = "Blind" selection is valid, with the actuator moving the blind upwards for the preset duration (number of steps x parameterized short operation).  
It must be remembered that the actuator has been designed to control the most common types of blinds. The actuator assumes that the slats are completely closed during the downward movement and that they will open during an upward movement.  
When the "Blind/shutter type" is a "Shutter", there is no positioning of the slats during the sun protection.

During an activated sun protection function, no operation by means of short (Step) or long (Move) objects is possible.



Response at the end of the sun protection function":

At the end of the sun protection function, the actuator immediately re-enables the outputs channels concerned and moves the blind/shutter into the respective limit positions for the "UP" and "DOWN" settings. If the response at the end of the sun protection function is parameterized for "No reaction" or "Stop", there will be no new movement. If the sun protection is deactivated by "No reaction" while the sun protection positioning movement is still in progress, the movement will be completed (movement as for sun protection long operation). If the sun protection is deactivated by "Stop" while the sun protection positioning movement is still in progress, the movement is interrupted instantaneously.

#### Remarks on the sun protection function:

- Sun protection movements including the reference movement before sun protection are not retriggerable.
- On return of bus voltage, the sun protection functions are always deactivated.
- An object update of the sun protection objects from "Deactivated" to "Deactivated" shows no reaction. An update from "Activated" to "Activated" restarts the corresponding sun protection function only if this function was interrupted beforehand by manual control or by a safety function.
- The safety function interrupts the sun protection function. A safety-locked output cannot be influenced by a sun protection function.  
A sun protection function becomes active only after deactivation of the safety lock and a new telegram update of the sun protection object and, if necessary, of the enabled output.  
Long (Move) or short (Step) commands issued during an active sun protection function are disregarded.

## Central function

The central function is only available in the switching channels and can be preset as a 1-bit switching function or optionally as 2-bit priority control. The central function is activated resp. deactivated by object 16.

Central function "Switching (1 bit)":

Object 16 is structured as a 1-bit object. The switching channels assigned to the central function are controlled in accordance with the central object value received ("1": switching on / "0": switching off). The behaviour of the channels is identical to the 'normal' switching function when controlled via the "Switching" objects, i.e. time functions will be taken into consideration if they are parameterized. The response with the 1-bit central function is comparable to a central group address assigned to all "Switching" objects. The parameterized relay operation is evaluated, too.

The switching status set by the central function is retained in the "Switching" objects.

Central function "Priority control (2-bit / priority)":

Objec 16 is structured as a 2-bit object in acc. with EIS 8. With the central object, the switching channels assigned to the central function can be forced separately into a switching position and this independent of the values of the "Switching" objects. The "Relay operation" parameter is active here, too. The value of the 2-bit telegram must be selected in acc. with the following syntax:

The first bit (bit 0) of the priority control object indicates the switching status with priority.  
The second bit (bit 1) of the priority control object activates resp. deactivates the priority control

Bit 1	Bit 0	Function
0	x	priority not active, ⇔ 'switching' object
0	x	priority not active, ⇔ 'switching' object
1	0	priority active: switching off
1	1	priority active: switching on

## instabus EIB System

### Actuator

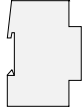

At the beginning of priority control, all time functions are stopped.

When priority is active, the internal evaluation of switching telegrams received continues. During the deactivation of priority control, the switching status is set in compliance with the value of the switching object retained. Time functions are not taken into account. If no switching telegrams have been received or retained during active priority control, the relay status activated before priority control is reactivated.

#### Remarks on the central function:

- After return of bus voltage, the central function is always deactivated.
- An object update of the central object ("Switching on" after "Switching on" resp. "Switching off" after "Switching off") is always re-executed for the 1-bit central function. An object update of the central object ("Priority active" after "Priority active" resp. "Priority inactive" after "Priority inactive") shows no reaction with the 2-bit central function.
- A priority control active before manual control remains activated after deactivation of the manual control mode (switching channels locked). The switching status in acc. with the priority control is re-executed only after an update of the priority control function.
- Switching statuses preset by a 1-bit central function will be retained in the "Switching" objects.
- A switching output assigned to the 2-bit central function can no longer be assigned to the inhibit function. Assignment of a switching output to the 1-bit central function and to the inhibit function is, however, possible.
- The 1-bit central function has the same priority as the "Switching" objects.

### Inhibit function

The inhibit function is available only for the switching channels and is activated and deactivated by object 18. It permits disabling of the switching outputs assigned. The inhibit function is enabled by the central function as an alternative to the second sun protection function of the blind/shutter outputs.

During an active inhibit function, the channels cannot be controlled by means of the "Switching" objects. The polarity of the inhibit object is fixed as follows: "1" = inhibit active / "0" = inhibit inactive.

Only the output channels assigned to the inhibit function show a reaction. The response of the channels at the beginning and at the end of an inhibit function can be generally fixed.

"Response at the beginning of an inhibit function":

Depending on the relay operation parameterized, the actuator can switch the outputs optionally "on" or "off". The outputs are interlocked. In the "No reaction" setting, the switching outputs remain in the state set before the inhibit function.

"Response at the end of an inhibit function":

Depending on the relay operation parameterized, the actuator can switch the outputs optionally "on" or "off". Time functions are disregarded. The outputs are re-enabled. In the "No reaction" setting, the switching outputs remain in the state prevailing at the beginning of the inhibit function.

#### Inhibit function information:

- After return of bus voltage, the inhibit function is always deactivated.
- An object update of the inhibit object "Deactivated" after "Deactivated" shows no reaction. An update from "Activated" to "Activated" restarts the inhibit function only in case the function has been interrupted beforehand by manual control.
- Switching states set by an inhibit function are not retained in the "Switching" objects.
- A switching output assigned to the 2-bit central function can no longer be assigned to the inhibit function. Assignment of a switching output to the 1-bit central function and to the inhibit function is, however, possible!



## Time functions for switching outputs

A time function can be parameterized for switching outputs 1 thru 8 with the possibility to activate an OFF-delay or alternatively a timer function (staircase lighting).

### OFF-delay:

After reception of a "0" telegram via the "Switching" object or a 1-bit central function "OFF", the output does not switch off immediately and the parameterized time delay begins to run. The output is switched off only after this delay has elapsed. The OFF-delay cannot be retriggered by an "OFF" telegram. An "ON" telegram during the OFF-delay interrupts this delay. The OFF-delay does not influence the value of the "Switching" object.

### Timer function:

After reception of a "1" telegram via the "Switching" object or a 1-bit central function "ON", the output channel is switched on and the parameterized time delay is started.

After this delay, the output switches off automatically. The timer function can be retriggered by a switch-on command. The timer function influences the value of the "Switching" object so that a "0" is retained in the "Switching" object after the delay has elapsed.

An "OFF" telegram received during the time delay (ON-time) can be disregarded with timer functions. Depending on the "Response to OFF telegram" parameter, the output either switches off prematurely ("Switch off" setting) or the switch-off telegram is disregarded and the output switches off only after the end of the time delay ("Ignore OFF telegram" setting).

No timer functions available for switching outputs 9 thru 16!

## Priorities of the blind/shutter resp. switching functions

All functions of the actuator are governed by fixed priority rules.

Priorities for the blind/shutter functions:

- Manual control (highest priority)
- Safety function
- Sun protection function
- Operation by short or long command (lowest priority)

The safety function interrupts the sun protection function and all other bus-controlled movements of the blind or the shutter. A safety-locked output cannot be influenced by a sun protection function. The safety function can only be interrupted by a manual control.

A sun protection function becomes active again only after the safety lock has been deactivated and after a new telegram update of the sun protection object and, if necessary, of the enabled output.

Long or short commands during active manual control or a safety or sun protection function are disregarded.

Priorities for the switching functions:

- |   |    |                                   |                    |
|---|----|-----------------------------------|--------------------|
| • Manual control  | or | • Manual control                  | (highest priority) |
| • Inhibit function  |    | • Central function 2 bits         |                    |
| • Central function 1 bit /<br>operation by switching commands |    | • Operation by switching commands | (lowest priority)  |

## instabus EIB System

### Actuator

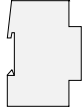

A distinction must be made between a 1-bit central function or a priority control (2 bits) being assigned to an output.

With priority control, no inhibit function is possible. In this case, a central function can only be interrupted by manual control. During an active priority control, the switching commands received via the bus are retained internally and abandoned only at the end of a priority control.

With a 1-bit central function, an inhibit function is available. The inhibit function has a higher priority than the central function or an operation by "Switching" objects and can only be interrupted by a manual control. A control of the relay outputs by the "Switching" object ranks on the same level as a 1-bit central function.

### Bus and mains voltage / Programming procedure

#### Response to bus voltage failure:

The response in case of bus voltage failure only is fixed by the "Response to bus voltage failure" parameter separately for each blind/shutter or switching output. The following actions can be parameterized: blind or shutter moving to upper limit position ("UP"), blind or shutter moving to lower limit position ("DOWN"), movements in progress being stopped ("Stop") or no reaction taking place ("No reaction" / any movements still in progress will be completed). The switching channels can close ("Close contact"), open ("Open contact") or show no reaction in the event of bus voltage failure ("No reaction" / switching state maintained). Depending on the "Manual control in case of bus voltage failure" parameter on the "General" card, manual control is possible.

#### Response to mains voltage failure:

The actuator needs a mains voltage supply for operation. In the event of mains voltage failure, all outputs switch off or are stopped. Manual control is then no longer possible. Any safety or central functions ("Priority control" 2 bits) remain active. Sun protection or inhibit functions are rejected.

#### Response to bus and mains voltage failure:

Like with a normal mains failure, all outputs switch off or are stopped. Manual control is then no longer possible. Any bus-activated safety functions and also central, sun protection or inhibit functions are rejected.

#### Response on return of bus voltage:

The response depends on whether mains voltage is present or not when the bus voltage returns. If the mains is present on return of bus voltage, the reaction is fixed by the "Response on return of bus voltage" parameter separately for each blind or shutter output. The following actions can be parameterized: blind or shutter moving to upper limit position ("UP"), blind or shutter moving to lower limit position ("DOWN"), movements in progress being stopped ("Stop"). The switching channels can close ("Close contact"), open ("Open contact") or go back on return of bus voltage to the switching state held before bus voltage failure ("Value before bus voltage failure").

In the "Value before bus voltage failure" setting, the switching state that was active before bus voltage failure is restored. The parameterized relay operation (break or make) is taken into account. After programming with the ETS, the "Value before bus voltage failure" resp. the object value is always "0" so that a breaking contact (contact closed) closes and a making contact (contact opened) opens. The status LED in the LED array on the device is lit up when the switching contact is closed.

An activated manual control is terminated. An unprogrammed actuator is factory-adjusted for "Stop" resp. "Open contact" reaction in the event of bus voltage return.

If there is no mains voltage on return of the bus voltage, all output channels remain off or stopped. Bus communication is, however, possible, i.e. the safety function can be activated. Activations of the sun protection, inhibit or central function, of short (Step) or long (Move) commands or switching telegrams are rejected. Any safety function activated during the mains failure will be repeated when the mains voltage is restored later on.





If no safety function has been activated during the mains failure (bus voltage being present), the actuator executes the parameterized "Response to bus voltage return" when the mains is restored later on. Manual control is not possible.

#### Response to mains voltage return:

The response depends on whether bus voltage is present or not when the mains voltage returns. If bus voltage is present, the reaction of the blind/shutter function is fixed by the "Response on return of bus voltage" parameter separately for each blind or shutter output. The following actions can be parameterized: blind or shutter moving to upper limit position ("UP"), blind or shutter moving to lower limit position ("DOWN"), movements in progress being stopped ("Stop"). For all switching channels, the switching state that was active before mains voltage failure is restored on return of the mains (bus voltage being present). Manual control is possible.

#### Exceptions:

1. In the blind/shutter function, the actuator automatically reactivates the safety function in the outputs assigned, if the safety object was activated before or during the mains failure. The parameterized "Response at the beginning of the safety function" is re-executed. A safety function activated before the mains failure and deactivated during the failure causes a new movement on return of mains voltage as parameterized for "End of the safety function". If, during mains failure, a safety function was activated and then deactivated again, the actuator does not launch a new movement for the outputs assigned after return of the mains voltage. The outputs concerned are in any case re-enabled after safety deactivation. The sun protection functions are deactivated.
2. In the switching function, the actuator automatically reactivates the central function (only with 2-bit "Priority control"), if the priority control was activated before the mains failure. Deactivation of the priority control during mains failure is then not possible. The inhibit function is deactivated, i.e. the switching channels are enabled.

If the bus voltage is not present on return of mains voltage, the parameterized "Response to bus voltage failure" is launched separately for each blind/shutter or switching output (in unprogrammed actuators, "Stop" or "Open contact" are factory-adjusted). Manual control is possible.

#### Response to bus and mains voltage return:

The parameterized "Response to bus voltage return" is launched separately for each blind/shutter or switching output. In this case, manual control is possible. (Cf. also "Response to bus voltage return" / "Response to mains voltage return")

#### Programming procedure:

After the end of ETS programming or after a bus reset (bus voltage return), the parameterized "Response to bus voltage return" is executed separately for each blind/shutter or switching output. In the "Value before bus voltage return" setting for the switching outputs, the switching state that was active before bus voltage failure is restored. The parameterized relay operation (break or make) is taken into account. After programming with the ETS, the "Value before bus voltage failure" resp. the object value is always "0" so that a breaking contact (contact closed) closes and a making contact (contact opened) opens. The status LED in the LED array on the device is lit up when the switching contact is closed. After a programming cycle, the manual control mode is terminated.

# instabus EIB System

## Actuator

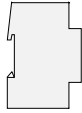

### Manual control depending on bus and mains voltage:

Manual control is only possible when mains voltage is present. Depending on the "Manual control on bus voltage failure" parameter on the "General" card, manual control with no bus voltage applied is possible. An activated manual control mode ends on return of bus voltage.

### Manual control

The actuator as delivered has the manual control mode already enabled. The four keys on the device front panel permit comfortable local operation of the up to 16 output channels also without bus voltage being present. The different operating states are indicated by up to 19 red LEDs. For manual control, the mains supply must be on.

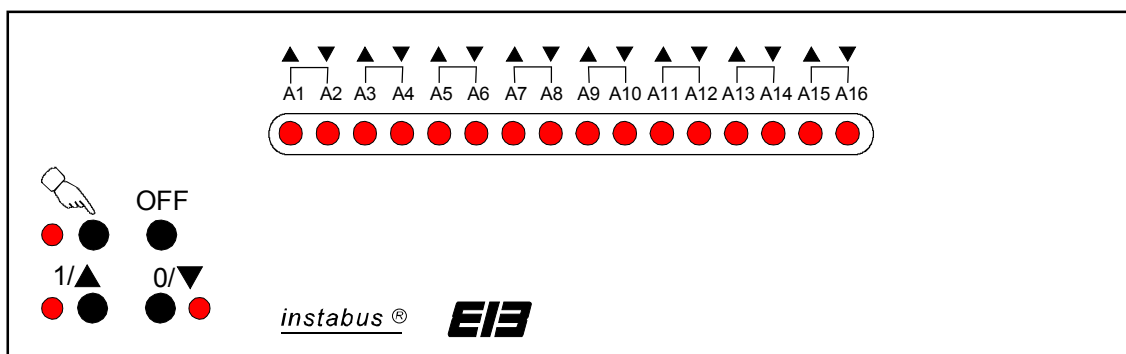

### Activation of manual control and operation:

The manual control mode can be activated temporarily or permanently.

#### Permanent manual control:

**Activation:**

1. Press the "👉" key for at least 5 seconds,
2. the red LED beside the "👉" key lights up statically. The actuator is now permanently in the manual control mode, control from the EIB is disabled and all blind/shutter output channels are stopped. The switching outputs remain in the state that was active before the activation of manual control.

**Operation:** A short press (< 1 second) on the "👉" key selects the output channel which is to be operated by manual control. The actuator distinguishes between blind/shutter or switching function also in the manual control mode. The two status LEDs (▲ ▼) of the output selected in the LED array start flashing, if the channel is one parameterized for blind/shutter operation. If only one status LED flashes (▲ or ▼), the selected channel is a switching channel. Pressing the select key repeatedly permits switching between all outputs. The "1/▲" and "0/▼" keys can be used to control the selected output channel and to modify the switching status and the sense of movement. The LEDs beside the keys indicate the switching state of the selected channel. The switching states of non selected outputs are indicated as for 'normal' bus operation by means of the LEDs of outputs A1 thru A16 in the LED array.

**Deactivation:**

- by pressing the "👉" key for at least 5 secs. until the corresponding LED goes out or
- by bus reset or reapplication of bus voltage (return of bus voltage), or
- by switching off the mains voltage.



### Central OFF / Stop function:

When the actuator is in the permanent manual control mode, all output channels can be shut off at the same time with the central OFF / Stop function (switching outputs) or stopped (blind/shutter outputs). A press on the "OFF" key executes the OFF / Stop function. All relays are switched off immediately. The central OFF / Stop function is available in the permanent manual control mode only!

### Temporary manual control mode:

**Activation:**

1. Press the "☞" select key briefly (< 1 sec.),
2. The red LED(s) of output channel 1 in the LED array start flashing. Both LEDs will flash, if the first output channel is parameterized as blind/shutter channel. Only one LED will flash, if the first channel is a switching channel. The actuator is now temporarily in the manual control mode, control from the EIB is disabled and all blind/shutter channels are stopped. The switching outputs remain in the state that was active before activation of the manual control mode. The red LED beside the select key is off!

**Operation:** A brief press (< 1 sec.) of the "☞" key selects the output channel which is to be controlled manually. The actuator distinguishes between blind/shutter or switching functions also in the manual control mode.

The two status LEDs (▲ ▼) of the output selected in the LED array start flashing, if the channel is one parameterized for blind/shutter operation. If only one status LED flashes (▲ or ▼), the selected channel is a switching channel. Pressing the select key repeatedly permits switching between all outputs. The temporary manual control mode is terminated automatically if the select key is pressed once again after the last output channel has been selected. After termination of the manual control mode, the actuator goes back to 'normal' bus operation.

The "1/▲" and "0/▼" keys can be used to control the selected output channel and to modify the switching status and the sense of movement. The LEDs beside the keys indicate the switching state of the selected channel. The switching states of non selected outputs are indicated as for 'normal' bus operation by means of the LEDs of outputs A1 thru A16 in the LED array.

**Deactivation:**

- if no further key is pressed after more than 5 seconds, or
- when the select key is pressed once again after all outputs channels have been selected once with the key, or
- by bus reset or reapplication of bus voltage (bus voltage return) or
- by switching off the mains voltage.

If the "☞" key is pressed in the temporary manual control mode for at least 5 seconds, the actuator changes over to permanent manual control. Pressing the "OFF" key in the temporary manual control mode yields no reaction!

On activation of the temporary or permanent manual control mode, all blind/shutter output channels are generally stopped and an active safety and sun protection function are aborted. The output channel control via the bus is disabled. The switching outputs remain in the state that was active before activation of the manual control mode. Time functions are not taken into account. The central or the inhibit function are aborted, too.

The safety function for blind/shutter outputs is reactivated after deactivation of the manual control mode, if it has not been cancelled. The sun protection functions are rejected or discontinued after deactivation of the manual control mode. If the blind/shutter outputs are in motion when deactivated, the movement is continued until the preset long operation elapses (counted from the moment of actuation).

The switching states remain unchanged after deactivation of the manual control mode. Time functions are not taken into account. A priority control (central function: 2 bits) active before the manual control mode remains activated (switching channels disabled) The switching state corresponding to the priority control is re-executed, however, only after an update of the priority control function.

## instabus EIB System

### Actuator

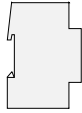

#### Manual control mode enable:

The manual control mode is available only when mains voltage is present. The manual control mode can be generally inhibited by selecting the parameter "Manual control = disabled" on the "General" card. Depending on the "Manual control on bus voltage failure" parameter, it is possible to specify in addition (with manual control generally disabled) whether a manual control is to be permitted even in the event of bus voltage failure. An activated manual control mode is terminated on return of bus voltage.

#### Manual control mode information:

- The parameterized "Break during change of movement direction" is taken into account also for the manual control mode (factory-adjusted to 1 second).
- The state of the switching channels adjusted during manual control is not retained in the "Switching" objects!
- In the manual control mode, the blind/shutter outputs permit only long operation (long depression of key) and stop commands (brief depression of key). When delivered ex factory (actuator not yet programmed), the long operation is factory-adjusted to 'infinite'. After programming of the device with the ETS, the movement time parameterized on the "Movement time" card under "Long operation" is applicable.

#### Settings of the actuator when delivered ex factory

When delivered ex factory, the actuator is adjusted to the the following parameters:

- All outputs are preset as blind/shutter channels
- Long operation time: infinite
- Short operation: only stop
- Break during change of movement direction: 1 s
- Reaction after bus voltage failure: Stop / Open contact
- Reaction on return of bus voltage: Stop / Open contact
- Manual control: completely enabled



<b>Parameters</b>		
Description:	Values:	Comment:
General		
Manual control mode	<p><b>enabled</b></p> <p>disabled</p>	<p>In the manual control mode, the output channels can be switched manually. Manual control is available only if mains voltage is present.</p> <p>Manual control is generally available.</p> <p>Manual control is not available when bus voltage present.</p>
Manual control in case of bus voltage failure	<p><b>enabled</b></p> <p>disabled</p>	<p>Manual control additionally permitted in the event of bus voltage failure.</p> <p>Manual control can only be activated in the event of bus voltage failure.</p> <p>Activation of manual control generally not possible.</p> <p>Only if "Manual control " = "disabled"!</p>
Auxiliary function (HA)	<p>inhibit function (for switching operation)</p> <p><b>sun protection function 2 (for blind/shutter operation)</b></p>	<p>Defines the auxiliary function (object 18).</p> <p>Enables the inhibit functions which are valid for switching functions only.</p> <p>Enables the second sun protection function which is valid for blind/shutter functions only.</p>
Function object 'Central function' for switching (HA)	<p><b>switching (1 bit)</b></p> <p>priority control (2 bits)</p>	<p>Defines the type of central function which is valid for switching channels only.</p> <p>The central function is designed as switching function (EIS 1).</p> <p>The central function is designed as priority control function (priority / EIS 8).</p>
Selection		
Function output 1 / output 2	<p>2 x switching</p> <p><b>1 x blind/shutter</b></p>	<p>Defines the function of output pair A1 / A2.</p> <p>A1 and A2 are two separate switching channels.</p> <p>A1 and A2 are combined into a blind/shutter channel.</p>
Function output 3 / output 4	<p>2 x switching</p> <p><b>1 x blind/shutter</b></p>	<p>Defines the function of output pair A3 / A4.</p> <p>A3 and A4 are two separate switching channels.</p> <p>A3 and A4 are combined into a blind/shutter channel.</p>

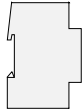

 Selection		
Function output 5 / output 6	2 x switching  <b>1 x blind/shutter</b>	Defines the function of output pair A5 / A6.  A5 and A6 are two separate switching channels.  A5 and A6 are combined into a blind/shutter channel.
Function output 7 / output 8	2 x switching  <b>1 x blind/shutter</b>	Defines the function of output pair A7 / A8.  A7 and A8 are two separate switching channels.  A7 and A8 are combined into a blind/shutter channel.
Function output 9 / output 10	2 x switching  <b>1 x blind/shutter</b>	Defines the function of output pair A9 / A10.  A9 and A10 are two separate switching channels.  A9 and A10 are combined into a blind/shutter channel.
Function output 11 / output 12	2 x switching  <b>1 x blind/shutter</b>	Defines the function of output pair A11 / A12.  A11 and A12 are two separate switching channels.  A11 and A12 are combined into a blind/shutter channel.
Function output 13 / output 14	2 x switching  <b>1 x blind/shutter</b>	Defines the function of output pair A13 / A14.  A13 and A14 are two separate switching channels.  A13 and A14 are combined into a blind/shutter channel.
Function output 15 / output 16	2 x switching  <b>1 x blind/shutter</b>	Defines the function of output pair A15 / A16.  A15 and A16 are two separate switching channels.  A15 and A16 are combined into a blind/shutter channel.



Inhibit function (switching) (HA) only if "Auxiliary function" = "Inhibit function"!												
Response at the beginning of the inhibit function (all switching outputs assigned) (HA)	<p>no reaction</p> <p>switching on</p> <p><b>switching off</b></p>	<p>During an active inhibit function, telegram updates of the "switching" objects are rejected.</p> <p>The state of the assigned switching outputs does not change at the beginning of an inhibition.</p> <p>The switching outputs assigned are switched on at the beginning of the inhibition.</p> <p>The switching outputs assigned are switched off at the beginning of the inhibition.</p> <p>The "relay operation" parameterized is taken into account!</p>										
Response at the end of the inhibit function (all switching outputs assigned) (HA)	<p><b>no reaction</b></p> <p>switching on</p> <p>switching off</p>	<p>At the end of an inhibit function, the "switching" objects are re-enabled.</p> <p>The state of the assigned switching outputs does not change at the end of an inhibition.</p> <p>The switching outputs assigned are switched on at the end of the inhibition. Parameterized time functions, if any, are not taken into account.</p> <p>The switching outputs assigned are switched off at the end of the inhibition.</p> <p>The "relay operation" parameterized is taken into account!</p>										
Inhibit function (switching) (HA) only if "Auxiliary function" = "Inhibit function"!												
Short operation (Step) base	<table border="0"> <tr> <td><b>10 ms</b></td> <td>150 ms</td> </tr> <tr> <td>50 ms</td> <td>500 ms</td> </tr> <tr> <td>100 ms</td> <td>1 s</td> </tr> </table>	<b>10 ms</b>	150 ms	50 ms	500 ms	100 ms	1 s	Defines the time base for short operation. step duration = factor · base				
<b>10 ms</b>	150 ms											
50 ms	500 ms											
100 ms	1 s											
Short operation (Step) factor (0..255) (0= Stop)	0 ... 255 <b>(Default 50)</b>	Defines the time factor for short operation. step duration = factor · base preset value: 10 ms · 50 = 500 ms										
Long operation (Move) base	<table border="0"> <tr> <td>50 ms</td> <td>5 s</td> </tr> <tr> <td>100 ms</td> <td>10 s</td> </tr> <tr> <td><b>500 ms</b></td> <td>1 min</td> </tr> <tr> <td>1 s</td> <td>10 min</td> </tr> <tr> <td>1,5 s</td> <td></td> </tr> </table>	50 ms	5 s	100 ms	10 s	<b>500 ms</b>	1 min	1 s	10 min	1,5 s		Defines the time base for long operation. step duration = factor · base
50 ms	5 s											
100 ms	10 s											
<b>500 ms</b>	1 min											
1 s	10 min											
1,5 s												







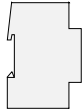

Safety (blind/shutter) (HA)		
Response at the end of the safety function (for all blind/shutter outputs assigned) (HA)	<p><b>no reaction</b></p> <p>move upwards</p> <p>move downwards</p>	<p>Fixes the reaction at the end of a safety function. After deactivation of a safety function, the actuation via the step / move objects is reenabled.</p> <p>The blind/shutter outputs assigned remain in their position or continue to run, when the safety function is deactivated while a movement is still in progress.</p> <p>The blind/shutter outputs assigned move upwards.</p> <p>The blind/shutter outputs assigned move downwards.</p>
Sun protection (blind/shutter) (HA) only if "Auxiliary function" = "Inhibit function" resp. Sun protection 1 (blind/shutter) (HA) only if "Auxiliary function" = "Sun protection function 2"!		
Long operation (Move) base (HA)	same as long operation (Move) base on "Movement time" card!	Dummy parameter without further functions.  <u>Info:</u> For sun protection, the respective blinds or shutters can be moved to a defined position. The sun protection position is approached from the upper limit position and is determined by the time to be set separately for long operation. The base for long operation is the same as the one parameterized on the "Movement time" card.
Long operation (Move) factor (3..255) (HA)	3...255 <b>(Default 60)</b>	For sun protection, the respective blinds or shutters can be moved to a defined position. The sun protection position is approached from the upper limit position and is determined by the time to be set separately for long operation.  $\text{Long moving time} = \text{factor} \cdot \text{base}$

Actuator



<p> Sun protection (blind/shutter) (HA) only if "Auxiliary function" = "Inhibit function" resp.                  Sun protection 1 (blind/shutter) (HA) only if "Auxiliary function" = "Sun protection function 2"!</p>		
<p>Response at the end of a sun protection function (all blind/shutter outputs assigned) (HA)</p>	<p>no reaction</p> <p><b>move upwards</b></p> <p>move downwards</p> <p>stop</p>	<p>Defines the reaction of the blind/shutter at the end of a sun protection function. After deactivation of a sun protection function, the actuation via the step / move objects is reenabled.</p> <p>The blind/shutter outputs assigned remain in their position or continue to run, when the safety function is deactivated while a movement is still in progress.</p> <p>The blind/shutter outputs assigned move upwards.</p> <p>The blind/shutter outputs assigned move downwards.</p> <p>The blind/shutter outputs assigned are stopped (relay contacts opened).</p>
<p>Number of steps after long operation movement (0...15) (HA)</p>	<p>0...15 <b>(Default 0)</b></p>	<p>After reaching the sun protection position, an output for which "Type of blind/shutter" = "Blind" can be used to tilt or to reposition the slats. The slats can be adjusted with one or more short commands (steps). This parameter defines the number of steps to be executed after sun protection positioning (upward movement).</p> <p>When number = "0", there is no slat adjustment (slats completely closed as for downward movement).</p>
<p> Sun protection 2 (blind/shutter) (HA) only if "Auxiliary function" = "Sun protection function 2"!</p>		
		<p>See sun protection 1!</p>



Output 1 only if "function output 1 / output 2" = "2 x switching"!																		
Function	switching	Info parameter without further functions.																
Relay operation	<p><b>making contact</b></p> <p>breaking contact</p>	<p>The type of relay control for a switching output can be fixed.</p> <p>"1" telegram resp. "switch-on" command: relay contact is closed. "0" telegram resp. "switch-off" command: relay contact is opened.</p> <p>"1" telegram resp. "switch-on" command: relay contact is opened. "0" telegram resp. "switch-off" command: relay contact is closed.</p> <p>The red status LEDs in the LED array on the device are on when a relay contact is closed!</p>																
Time function (HA)	<p><b>none</b></p> <p>Shut-off delay</p> <p>timer function</p>	<p>For switching outputs, a time function can be activated.</p> <p>No time function activated.</p> <p>The OFF-delay is active. Active channels are shut off with a delay after reception of an OFF telegram.</p> <p>The timer function (staircase lighting) is active. The preset time begins to run when a channel is switched on via the "Switching" object. When the preset time has elapsed, the channel is switched off automatically and the "Switching" object retains the "0" value.</p> <p>The time functions are available only for outputs 1 thru 8!</p>																
Factor (3...127) (HA)	3...127 <b>(Default 10)</b>	<p>Definition of the time factor for the selected delay.</p> <p>Delay time = factor · base</p> <p>Only if "Time function" = "Shut-off delay" or "Timer function"!</p>																
Base (HA)	<table border="0"> <tr><td>130 ms</td><td>34 s</td></tr> <tr><td>260 ms</td><td>1,1 min</td></tr> <tr><td>520 ms</td><td>2,2 min</td></tr> <tr><td>1 s</td><td>4,5 min</td></tr> <tr><td>2,1 s</td><td>9,0 min</td></tr> <tr><td>4,2 s</td><td>18 min</td></tr> <tr><td>8,4 s</td><td>35 min</td></tr> <tr><td>17 s</td><td>1,2 h</td></tr> </table>	130 ms	34 s	260 ms	1,1 min	520 ms	2,2 min	1 s	4,5 min	2,1 s	9,0 min	4,2 s	18 min	8,4 s	35 min	17 s	1,2 h	<p>Definition of the time base for the selected delay time.</p> <p>Delay time = factor · base</p> <p>Preset value: 1 s · 10 = 10 s</p> <p>Only if "Time function" = "Shut-off delay" or "Timer function"!</p>
130 ms	34 s																	
260 ms	1,1 min																	
520 ms	2,2 min																	
1 s	4,5 min																	
2,1 s	9,0 min																	
4,2 s	18 min																	
8,4 s	35 min																	
17 s	1,2 h																	

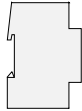

<p> Output 1 only if "function output 1 / output 2" = "2 x switching"!</p>		
<p>Response to OFF telegram (HA)</p>	<p><b>switch off</b></p> <p>ignore OFF telegram</p>	<p>In a timer function, an OFF telegram received during the delay (ON time) can be ignored.</p> <p>The OFF telegram is executed. The switching channel is switched off prematurely.</p> <p>The OFF telegram is ignored. The time delay is not interrupted.</p> <p>Only if "Time function" = "Timer function"!</p>
<p>Assignment to central function ? (HA)</p>	<p><b>no</b></p> <p>yes</p>	<p>The switching output is not integrated in the central function.</p> <p>The switching output is integrated in the central function.</p>
<p>Assignment to inhibit function? (HA)</p>	<p><b>no</b></p> <p>yes</p>	<p>The switching output is not integrated in the inhibit function.</p> <p>The switching output is integrated in the inhibit function.</p> <p>Only if "Auxiliary function" = "Inhibit function"!</p>
<p>Response to bus voltage failure</p>	<p><b>no reaction</b></p> <p>close contact</p> <p>open contact</p>	<p>Fixes the reaction in the event of bus voltage failure.</p> <p>The switching state remains unchanged.</p> <p>The relay contact closes.</p> <p>The relay contact opens.</p>
<p>Response on bus voltage return</p>	<p>value before bus voltage failure</p> <p>close contact</p> <p><b>open contact</b></p>	<p>Fixes the reaction in the event of bus voltage return.</p> <p>The switching state that was active before bus voltage failure is restored. Parameterized relay operation (breaking contact or making contact) is taken into account. After programming with the ETS, the "Value before bus voltage failure" or the object value is always "0" so that the breaking contact closes (contact closed) and a making contact opens (contact open).</p> <p>The relay contact closes.</p> <p>The relay contact opens.</p>



Output 2	See Output 1	Only if "Function Output 1 / Output 2" = "2 x Switching"!
Output 3	See Output 1	Only if "Function Output 3 / Output 4" = "2 x Switching"!
Output 4	See Output 1	Only if "Function Output 3 / Output 4" = "2 x Switching"!
Output 5	See Output 1	Only if "Function Output 5 / Output 6" = "2 x Switching"!
Output 6	See Output 1	Only if "Function Output 5 / Output 6" = "2 x Switching"!
Output 7	See Output 1	Only if "Function Output 7 / Output 8" = "2 x Switching"!
Output 8	See Output 1	Only if "Function Output 7 / Output 8" = "2 x Switching"!
Output 9	See Output 1	Only if "Function Output 9 / Output 10" = "2 x Switching"!
Output 10	See Output 1	Only if "Function Output 9 / Output 10" = "2 x Switching"!
Output 11	See Output 1	Only if "Function Output 11 / Output 12" = "2 x Switching"!
Output 12	See Output 1	Only if "Function Output 11 / Output 12" = "2 x Switching"!
Output 13	See Output 1	Only if "Function Output 13 / Output 14" = "2 x Switching"!
Output 14	See Output 1	Only if "Function Output 13 / Output 14" = "2 x Switching"!
Output 15	See Output 1	Only if "Function Output 15 / Output 16" = "2 x Switching"!
Output 16	See Output 1	Only if "Function Output 15 / Output 16" = "2 x Switching"!
Output 1/2	Only if "Function Output 1 / Output 2" = "1 x Blind/shutter"!	
Function	blind/shutter actuator	Info parameter without further functions!
Blind/shutter type	<b>blind</b>  shutter	Fixes the blind/shutter type used.  Control of a blind with slats.  Control of a shutter (without slats).
Assignment to safety function ? (HA)	<b>no</b>  yes	The blind or shutter output is not integrated in the safety function.  The blind or shutter output is integrated in the safety function.
Only if "Auxiliary function" = "Inhibit function"!		
Assignment to sun protection function ? (HA)	<b>no</b>  yes	The blind or shutter output is not integrated in the sun protection function.  The blind or shutter output is integrated in the sun protection function.
Only if "Auxiliary function" = "Sun protection function 2"!		
Assignment to sun protection function ? (HA)	<b>none</b>  sun protection 1  sun protection 2	The blind or shutter output is not integrated in any of the two sun protection functions.  The blind or shutter output is integrated only in sun protection function 1.  The blind or shutter output is integrated only in sun protection function 2.

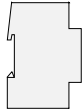

Output 1/2    Only if "Function Output 1 / Output 2" = "1 x Blind/shutter"!		
Only if "Auxiliary function" = "Sun protection function 2"!		
Response to bus voltage failure	<p><b>UP</b></p> <p>DOWN</p> <p>stop</p> <p>no reaction</p>	<p>Fixes the reaction in the event of bus voltage failure.</p> <p>The assigned blind or shutter outputs are set for upward movement.</p> <p>The assigned blind or shutter outputs are set for downward movement.</p> <p>The assigned blind or shutter outputs are stopped (relay contacts open).</p> <p>The assigned blind or shutter outputs remain in their actual position or continue the movement when the bus voltage failure occurs during a movement.</p>
Response on bus voltage return	<p>UP</p> <p>DOWN</p> <p><b>stop</b></p>	<p>Fixes the reaction in the event of bus voltage return.</p> <p>The assigned blind or shutter outputs are set for upward movement.</p> <p>The assigned blind or shutter outputs are set for downward movement.</p> <p>The assigned blind or shutter outputs are stopped (relay contacts open).</p>
Output 3/4    See Output 1/2    Only if "Function Output 3 / Output 4" = "1 x Blind/shutter"!		
Output 5/6    See Output 1/2    Only if "Function Output 5 / Output 6" = "1 x Blind/shutter"!		
Output 7/8    See Output 1/2    Only if "Function Output 7 / Output 8" = "1 x Blind/shutter"!		
Output 9/10    See Output 1/2    Only if "Function Output 9 / Output 10" = "1 x Blind/shutter"!		
Output 11/12    See Output 1/2    Only if "Function Output 11 / Output 12" = "1 x Blind/shutter"!		
Output 13/14    See Output 1/2    Only if "Function Output 13 / Output 14" = "1 x Blind/shutter"!		
Output 15/16    See Output 1/2    Only if "Function Output 15 / Output 16" = "1 x Blind/shutter"!		

**Software information**

- In order to be able to edit all parameters, the parameter editing function in the ETS must be set to "high access" (HA).
- The "Bus voltage readout" function (ETS function) is not available for this device!
- It must be ensured that the loads connected are compatible with the parameterization of the outputs. There is otherwise a risk of irreparable damage to blind/shutter motors, if they are connected to outputs parameterized as switching actuator outputs. For this reason, the loads connected must be checked before programming the device with the ETS. The movement directions in blind/shutter operation are interlocked only by the software.