

GIRA

GB

Instabus 2-Channel Timer Module

Operating Instructions

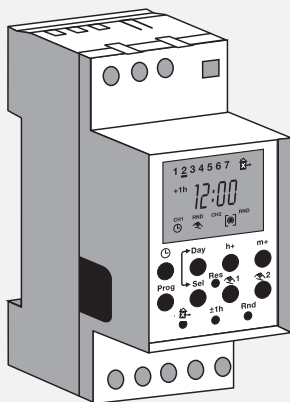

Centrally Controls Lights and Appliances

Using the Instabus 2-Channel Timer Module you can flexibly control several lights or appliances. With only one central timer. Either individually or in two groups. For example, the garden lighting as group one, the venetian blinds as group two, even if these items are connected to different electrical circuits.

If two switching groups are insufficient, a further Instabus module with two channels can be added.

The programming of your Instabus is performed by your installer. Simply tell him which lights and appliances are to be switched. You can set and change the on and off times yourself.

There are 42 memory locations for setting the on and off times. In each location a time, the day of the week and the group for which the setting is to apply can be saved. To the minute. Or using the random program.

In addition, individual times can be marked as belonging to the "holiday program". You can then switch over to your holiday settings at the touch of a button. And just as easily from summer time to winter time.

Requirements: an installed Instabus system with bus coupler module.

With Gira, your home is more comfortable, more secure and economical. You can find out what else Gira has on offer, as one of the leading manufacturers of modern systems for electrical installations, either from your installer, direct from Gira, or in the Internet under www.gira.de.

Contents	
Keys and Displays	4
Setting the Clock	5
Entering Switching Times	6
The Holiday Program	8
The Random Program	9
For the Installer	10
Technical Data	12
Manufacturer's Warranty	13

Keys and Displays

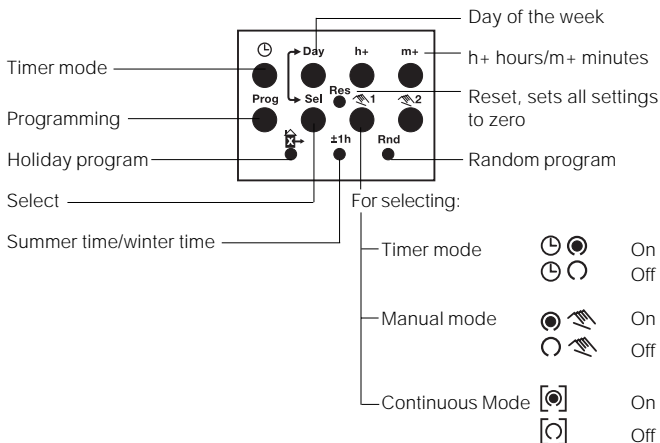
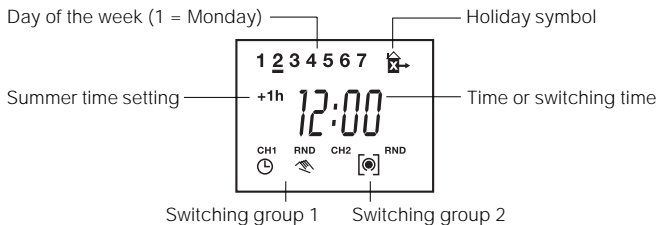

Setting the Clock

Time /Day of the Week

Press the \ominus key and keep pressed. Then set the hours and minutes using **h+** and **m+**, set the day of the week using **Day** (1 = Monday).

To advance the time quickly, keep **h+** or **m+** pressed.

Summer/Winter Time Change Over





Switch summer time on and off using $\pm 1h$.

For summer time +1h must be displayed.

Entering Switching Times

You can save 42 switching commands. Each command contains information on whether group one or two is to be switched, whether it is to be switched on or off, on which days of the week and at what time. – You can switch either one group or both groups together. Or: one group off and the other on at the same time.

You will find the entry of the switching times easier if you first write down what you want to enter (see table on last page).

1. Change to programming using the **Prog** key. If the first memory location is empty, --:-- is displayed. If not: press the **Prog** key as many times as necessary until the first empty location appears. A further press on the key then indicates how many memory locations are still empty.
2. Using 1 or 2 choose how the group is to be switched: on , off  or not at all (no symbol).
3. Using **h+** and **m+** set the time.
4. Select the day of the week using **Day** (1 = Monday) and confirm with **Sel**. If you made a mistake: select the day of the week again and confirm.
5. Press **Prog** to save. Then enter the next switching time or: end programming using the  key.

Flashing indicates: an entry is missing.



Changing Switching Commands



1. Using **Prog**, go to the required switching command.
2. Change old entry by overwriting it.
3. Save entry using **Prog** and end programming using 



Deleting Switching Commands

1. Using **Prog**, go to the required switching command.
2. Using **h+** and **m+**, set the display to --:--
3. To delete keep **Prog** pressed until --:-- indication no longer flashes. End programming using 

Manual Switching

You can interrupt the program at any time. To select, press the 1 and 2 key as many times as required. - Symbol:

  On (until the next automatic switching command is made)

  Off (until the next automatic switching command is made)

 On continuously

 Off continuously

 Timer mode







The Holiday Program

Entering Holiday Switching Times

Enter / change the switching times as described. However to mark the times, also press  before saving. Times marked in this way are then only used for the holiday program.

Starting the Holiday Program

Press  to switch to timer mode. Then choose one of the three options.

1. Continuous unlimited: press , start using 
2. Continuous for a set period: press . Using **Sel**, enter the number of days holiday (keep pressed to advance quickly), start using 
3. Continuous for a set period, but started up to 6 days later: press . Using **Sel**, enter the number of days holiday. Using **Day**, select the first day of holiday, start using 



With, for example, 10 days holiday, d:10 is displayed. The days are then counted down to the last day of holiday, the timer then changes back to the normal timer program.

Cancelling the Holiday Program



Simply press . – If the holiday program has already started, you only need to press once, otherwise press twice.

The Random Program

Switches on and off at irregular intervals. The duration of the switch on period is from 5 to 60 minutes, the duration of the switch off period from 5 to 30 minutes. The switching times are overridden. The random program can be separately selected for each group. - To do this:

Keep **Rnd** pressed, then press the 1 or 2 key.

Exit the random program in exactly the same way.



Or press 1 or 2 as often as necessary until timer mode  (without **Rnd**) is displayed.

Running the Random Program for a Set Period of Time

Here switching on and off is performed at irregular intervals between two defined times. Before and afterwards the normal switching program is run. – To do this:

Enter / change the switching times as described.

In addition to the switching on and switching off times, press **Rnd**. In this way the start and stop times for the random program are set.

End the random program in exactly the same way. – Or press 1 or 2 as often as necessary until timer mode  (without **Rnd**) is displayed.

For the Installer

Installation and fitting only by a qualified electrician.

Specialist knowledge from an Instabus training course is required.

Installation is only to be performed with the circuits isolated.

The unit is part of the Instabus EIB system. It complies with the EIBA directives. Planning, installation and placing in operation with the aid of EIBA-certified software.

The Instabus 2-Channel Timer Module sends messages over the Instabus. For this action the Instabus Bus Coupler Module is required. Only sensors or actuators are connected to this module (e.g. Instabus Timer Module, Instabus Brightness Sensor Module as sensors; e.g. Instabus Actuator Module). A maximum of 4 channels can be evaluated. (Function is software-dependent. For information see the product database at www.gira.de).

 The CE sign is a free trade sign addressed exclusively to the authorities and does not include any warranty of properties.

Placing in Operation

1. Clip the timer to the DIN rail next to the Bus Coupler Module and slide the two modules together (connection using 10-pole multiway connector). Leave the rechargeable battery to charge for approx. 5 minutes.
2. Press **Res** – This resets all entries to zero and the line for the day of the week flashes.
3. Set the time and the day of the week, as described above.

Technical Data

Ambient Temperature	-10 °C to +55 °C
Protection Class (VDE 0633)	II
Clock Precision	Typ. ± 2.5 s / day at +20 °C
Clock Backup	150 h at +20 °C
Charging Time	140 h NiCad rechargeable battery
Shortest Switching Time	1 min.
Programmable	Every minute
Memory Locations	42
Holiday Program	Max. 99 days
Summer/Winter Change Over	Yes
Sealable	Yes
Random Generator	Start/end time and day can be programmed as required

Manufacturer's Warranty

We grant the guarantee on our units - irrespective of claims arising out of the sales contract between the final consumer and the vendor - as follows:

1. Our warranty is limited at our discretion to the repair or replacement if the functioning is impaired or not ensured due to proven defects resulting from faults in material or workmanship.
2. The period of the guarantee is governed by our General Conditions of Sale. Adherence to this period must be justified by confirmation of purchase date in the form of invoice, delivery note or similar documents.
3. The costs of transport are borne in all cases by the purchaser.

Please return the unit postage paid to our central customer service center giving a brief description of the fault.

Gira
Giersiepen GmbH & Co. KG
Service Center
Dahlienstraße 12
D- 42477 Radevormwald
Federal Republic of Germany

Switching Times

	CH1	CH2	●	○	⌚	Day							Rnd	↔
						1	2	3	4	5	6	7		
1					:									
2					:									
3					:									
4					:									
5					:									
6					:									
7					:									
8					:									
9					:									
10					:									
11					:									
12					:									
13					:									
14					:									
15					:									
16					:									
17					:									
18					:									
19					:									
20					:									
21					:									
22					:									
23					:									
24					:									
25					:									
26					:									
27					:									

						Day								
	CH1	CH2	☉	☽	⌚	1	2	3	4	5	6	7	Rnd	↔
28					:									
29					:									
30					:									
31					:									
32					:									
33					:									
34					:									
35					:									
36					:									
37					:									
38					:									
39					:									
40					:									
41					:									
42					:									

CH1 _____ CH2 _____

Tip: copy this blank table as spares.
Keep the tables and operating instructions next to the timer.

Gira
Giersiepen GmbH & Co. KG
Postfach 1220
D- 42461 Radevormwald
Federal Republic of Germany
Telephone + 49 21 95 6 02 – 0
Fax + 49 21 95 6 02 – 3 39
Internet www.gira.de
E-Mail info@gira.de