

Product name:	Standard Presence Detector
Design:	Surface-mounted
Item no.:	0319 0x
ETS search path:	Gira Giersiepen, Phys. sensors, movement detectors, Standard presence detector

Functional description:

This Standard presence detector serves for both indoor presence (presence detector function mode) and indoor movement detection (ceiling-mounted detector function mode).

Two output channels that can be parameterised separately of each other are available in both modes.

The device is provided with an alarm function that responds to unplugging from the bus coupler.

The ceiling-mounted detector and presence detector modes can be set during the parameterisation of the device done by the ETS software.

Subsequent switching between the modes is **not** possible. Changing the mode necessitates re-programming.

The Standard presence detector can be used as a **single device** and should be exclusively mounted to the room ceiling from where it can monitor the area below.

It employs a passive infrared sensor (PIR) and responds to thermal movements triggered by persons, animals or objects.

The use of several Standard presence detectors within one room to extend the detection field is not possible. Both devices would affect each other. Neither is the use of the Standard presence detector possible in conjunction with a Komfort presence detector.

The purpose of a presence detector is to switch on the light when a movement is detected, depending on the brightness, and to switch it off when it is no longer needed. This will be the case, if there is sufficient brightness without any additional artificial light, and if nobody is present any longer.

This means that the presence of a person is detected in dependence on a preset brightness.

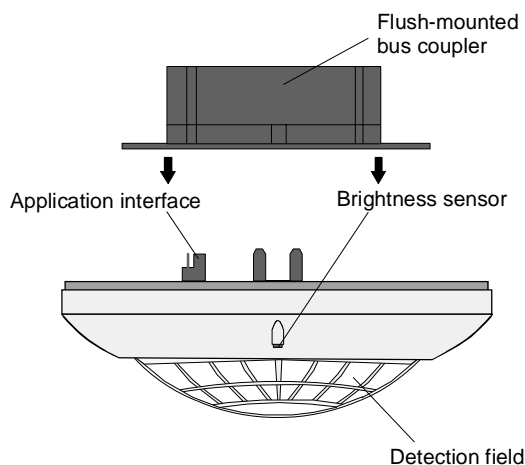
Illustration:**Dimensions:**

Diameter: 104 mm
Height: 40 mm

Controls:

- 1 potentiometer for infinitely variable reduction of the detection range between 100 % and 20%
- 1 potentiometer for setting an additional transmit delay by ± 50 %
- 1 potentiometer for fine setting of the twilight value preset by the software
- 1 brightness sensor

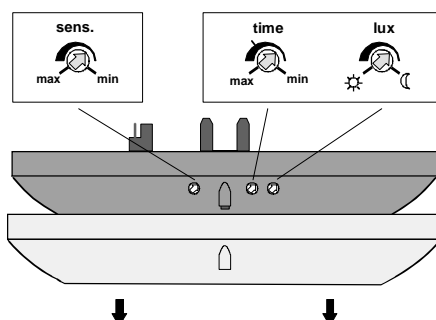

instabus EIB System

Sensor

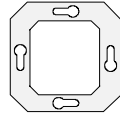

Specifications:

External supply:	---
instabus EIB supply	
Voltage:	24 VDC (+6 V / -4 V)
Power consumption:	typ. 150 mW
Connection:	instabus connecting and branch terminal
Input:	
Opening angle:	360°
Nominal detection range at desk height:	approx. 5 m dia.
Nominal detection range at floor level:	approx. 8 m dia.
Installation height for nominal detection range:	approx. 2.5 m
Number of lenses/detection levels:	80/6
Output:	---
Response to voltage failure	
Bus voltage only:	No response. (In case of bus voltage failure, active movements detected or delays in action will be discarded and not continued after bus voltage recovery.)
Mains voltage only:	---
Bus and mains voltages:	---
Response to re-closing	
Bus voltage only:	Depending on the software used. (Thermal movement detection immunity time: approx. 40 s.)
Mains voltage only:	---
Bus and mains voltages:	---
Protective system:	IP 20
Mark of conformity:	EIB
Ambient temperature:	-5 °C to +45 °C
Storage temperature:	-25 °C to +75 °C (storage above +45 °C will shorten the life)
Fitting position:	any (exclusively ceiling-mounted)
Minimum distances:	none
Type of fixing:	plugging onto flush-mounted bus coupler

Wiring diagram:

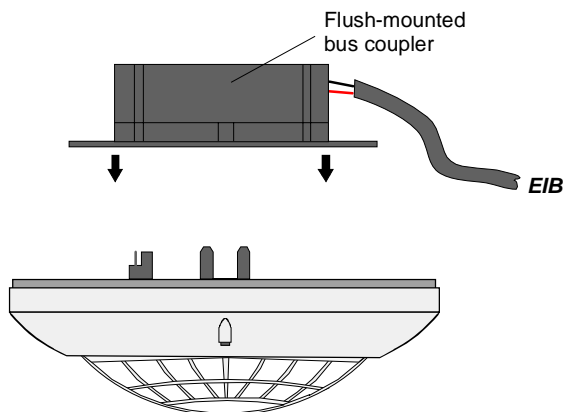

Terminal assignment:

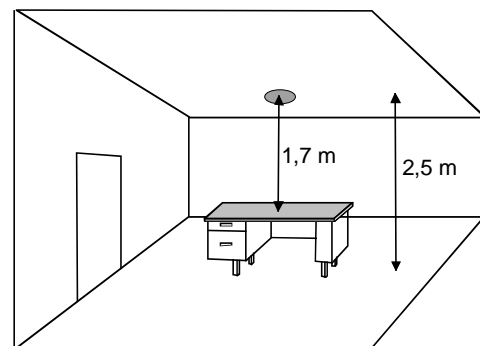



Detection field:

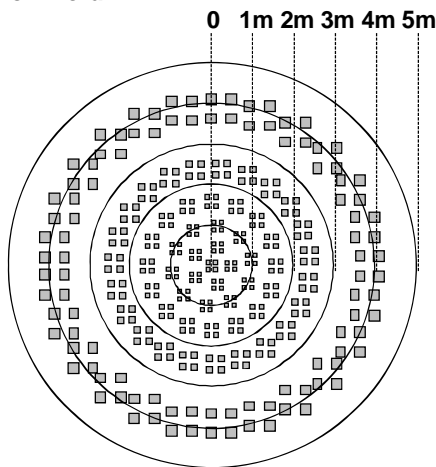

The Standard presence detector has an angle of detection of 360°.

The PIR sensors use six detection levels and 80 lenses.

At table height (approx. 80 cm), the detection range is about 5 m in diameter. At floor level, you can obtain a distance range diameter of about 8 m.

This information is referred to ceiling installation at a height of 2.5 m.

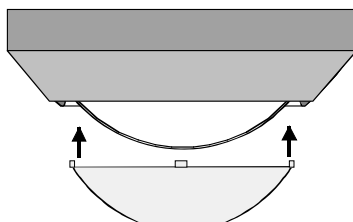
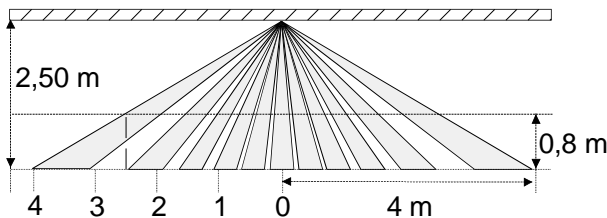

You can use the attached snap-on mask to eliminate undesired detection ranges or disturbance sources by restricting the detection field.

Just snap the mask onto the lens system. You can use a pair of scissors to cut sections out of the mask at the marked lines.

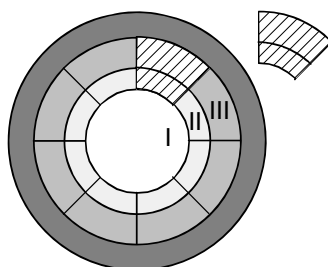

Cutting out will change the diameter of the detection field on the floor as follows:

- Entire mask without cut-outs, range I: approx. 2.20 m dia.
- Range II cut out: approx. 4.00 m dia.
- Ranges II+III cut out: approx. 6.00 m dia.
- Installation without mask: approx. 8.00 m dia.

This information is referred to an installation height of approx. 2.5 m.

instabus EIB System

Sensor

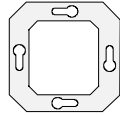

Remarks on the hardware:

- Do not install the presence detector in the close vicinity of a heat source such as a lamp. The lamp cooling down can be detected by the PIR sensors as a heat change and lead to the detection of a movement once again.
Use the attached snap-on mask to restrict the field of detection, if necessary.
Do not install in the vicinity of fans, radiators or ventilating ducts. Air draughts (e. g. also coming through open windows) may be detected and trigger another switching event. Choose the most suitable place of installation.
- Mount the Standard presence detector in a vibration-free manner as movements of the sensor may also trigger the device.
- The field of detection should not be obstructed by furniture, pillars, etc.
- Install the brightness sensor at the side opposite to the window to avoid undesired influences of scattered light.
- The brightness values determined by the presence detector depend on a few different factors.
So, for example, the reflection of the light by the surface directly under the presence detector plays a decisive role. Bright areas such as white paper on the desk naturally reflect considerably more light than a dark carpet floor, for example. This will possibly result in a necessary change of the presence detector setting if the bright desk under it is moved to a different place in the room, with a dark carpeted floor appearing instead.
- The less movements are to be expected within the monitored area, the longer the additional transmit delay should be chosen. This can avoid premature switching off of the light.

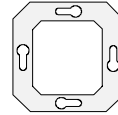

Software Description:

ETS search path:

Gira Giersiepen, Phys. sensors, movement detectors, Standard presence detector

ETS symbol:

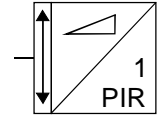

Applications:

Brief description:

Standard Presence Detector

Name:

Standard Presence Detector
A00E01

Date:

07.02

Page:

7

Data base

2.45

instabus EIB System

Sensor

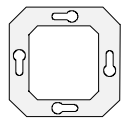

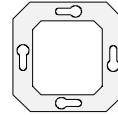

Application: **Standard Presence Detector A00E01**

Scope of functions

- Free assignment of the switching, dimming value transmitter and lightscape extension functions to the two outputs.
- Presence or ceiling-mounted detector function parameterisable. Mode change, e. g. by objects, while the device is in operation is not possible.
- Potentiometers for setting the twilight value and an additional transmit delay have a configuring effect on various outputs.
- The trigger object for starting the presence detector can be set, no matter whether something is detected or not.
- The inhibit time after the release of a message can be adjusted.
- The twilight value and the teach-in function can be parameterised for each output. The polarities of the teach-in objects can be preset. If the twilight value potentiometer acts on both outputs, setting the twilight value for output 1 will be sufficient.
- Cyclic transmitting during detection is possible (base and factor).
- The release of messages upon re-triggering can be parameterised.
- Message at the beginning and at the end of detection selectable.
- Message at the beginning and at the end of inhibit mode selectable. The polarities of the inhibit objects can be parameterised independently of one another.
- Additional transmit delay (base and function) selectable. The overall delay for the release of the message at the end of a detection event results from addition of the standard time delay (10 s) with the additional transmit delay.
- Switch-off hysteresis correction selectable. After double the value of the preset twilight value (switch-off brightness) is exceeded, the parameterised message will be transmitted at the end of the detection event after about 10 minutes, even though the presence of a person is detected. The switch-off brightness can be adapted through the correction value.
- Response upon bus voltage recovery separately parameterisable for each output.
- Removal message after unplugging the device from the flush-mounted bus coupler possible (1 bit/1 byte).

instabus EIB System

Sensor

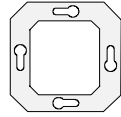

Objekt

Objektbeschreibung

- 0 - 1 Switching:** 1 bit object for transmitting switching messages (ON, OFF).
- 0 - 1 Dimming value:** 1 byte object for transmitting value messages (0 - 255), for example.
- 0 - 1 Lightscape extension:** 1 byte object for calling or storing lightscapes (1 -64).
- 2 - 3 Teach-in:** 1 bit object for setting the twilight value, no matter what the parameterisation and setting of the twilight value potentiometer are.
- 4 - 5 Inhibiting:** 1 bit object for inhibiting individual outputs.
- 6 Trigger object:** 1 bit object for switching on the presence detector, no matter whether something is detected or not.
- 7 Switching:** 1 bit object for alarm indication (unplugged presence detector).
- 7 Value:** 1 byte object for alarm indication (unplugged presence detector).

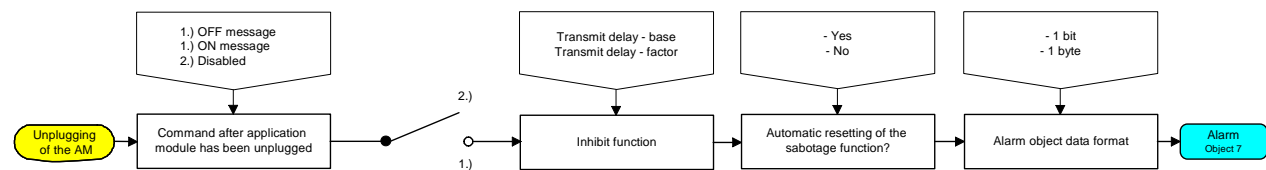
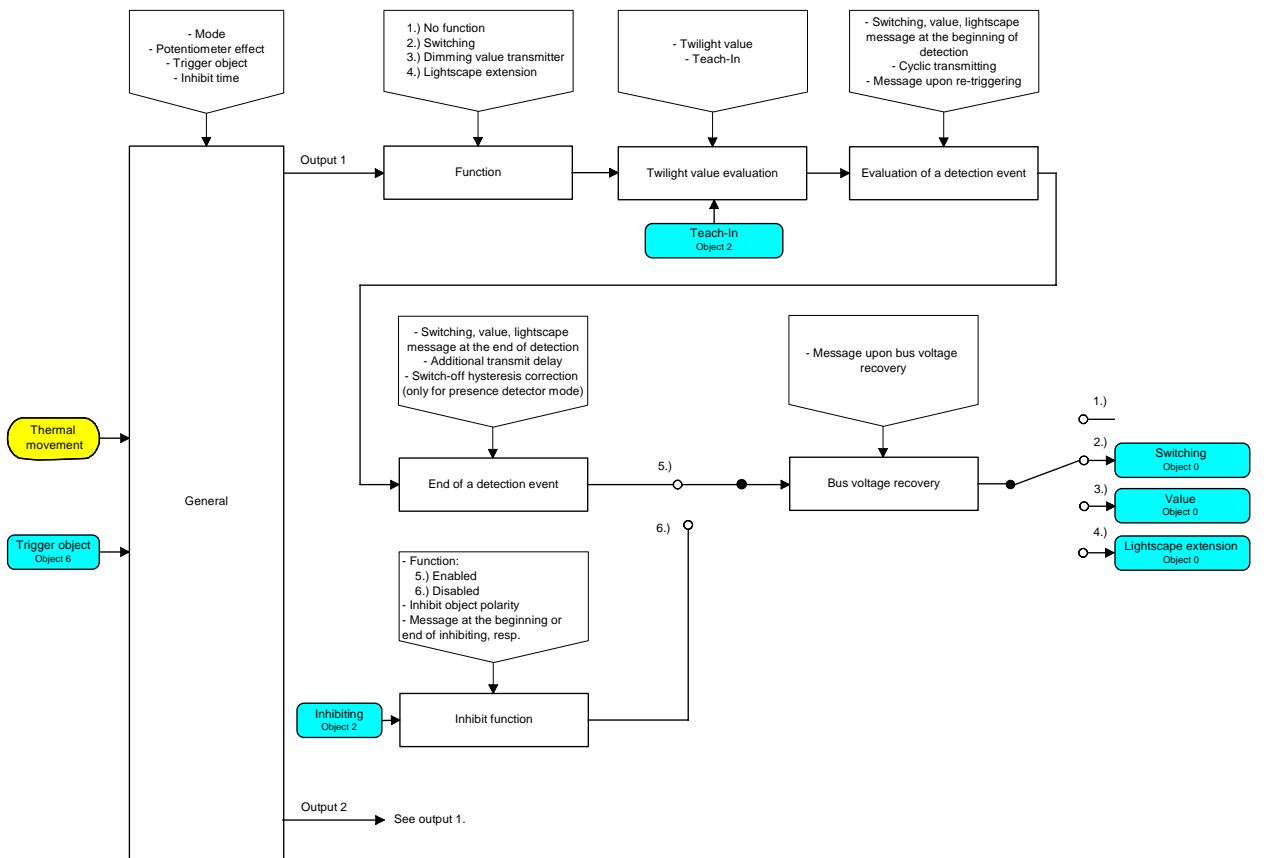

Logic Diagram

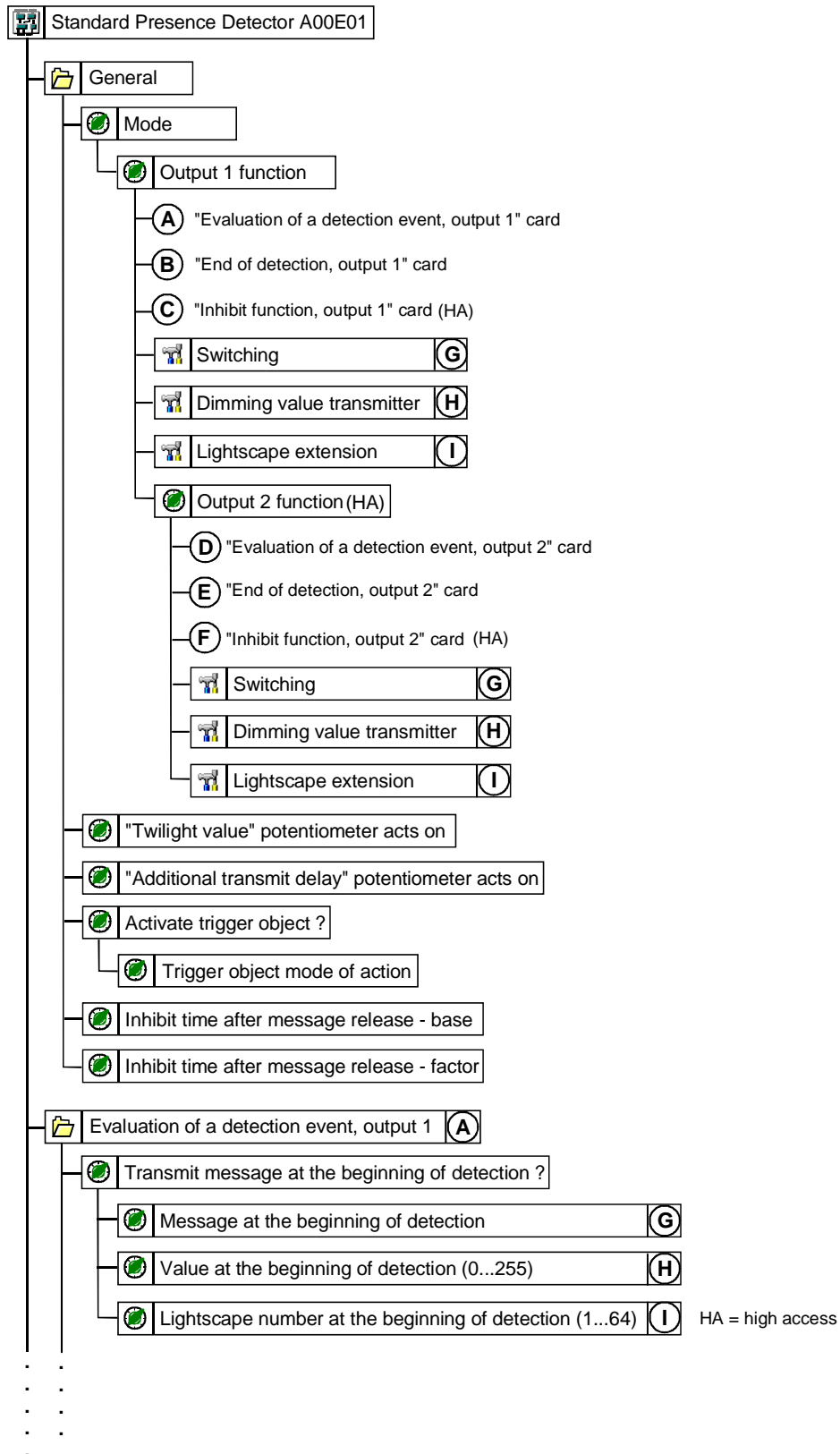
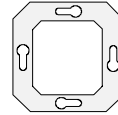

Parameter Diagram (1 / 3)

instabus EIB System

Sensor

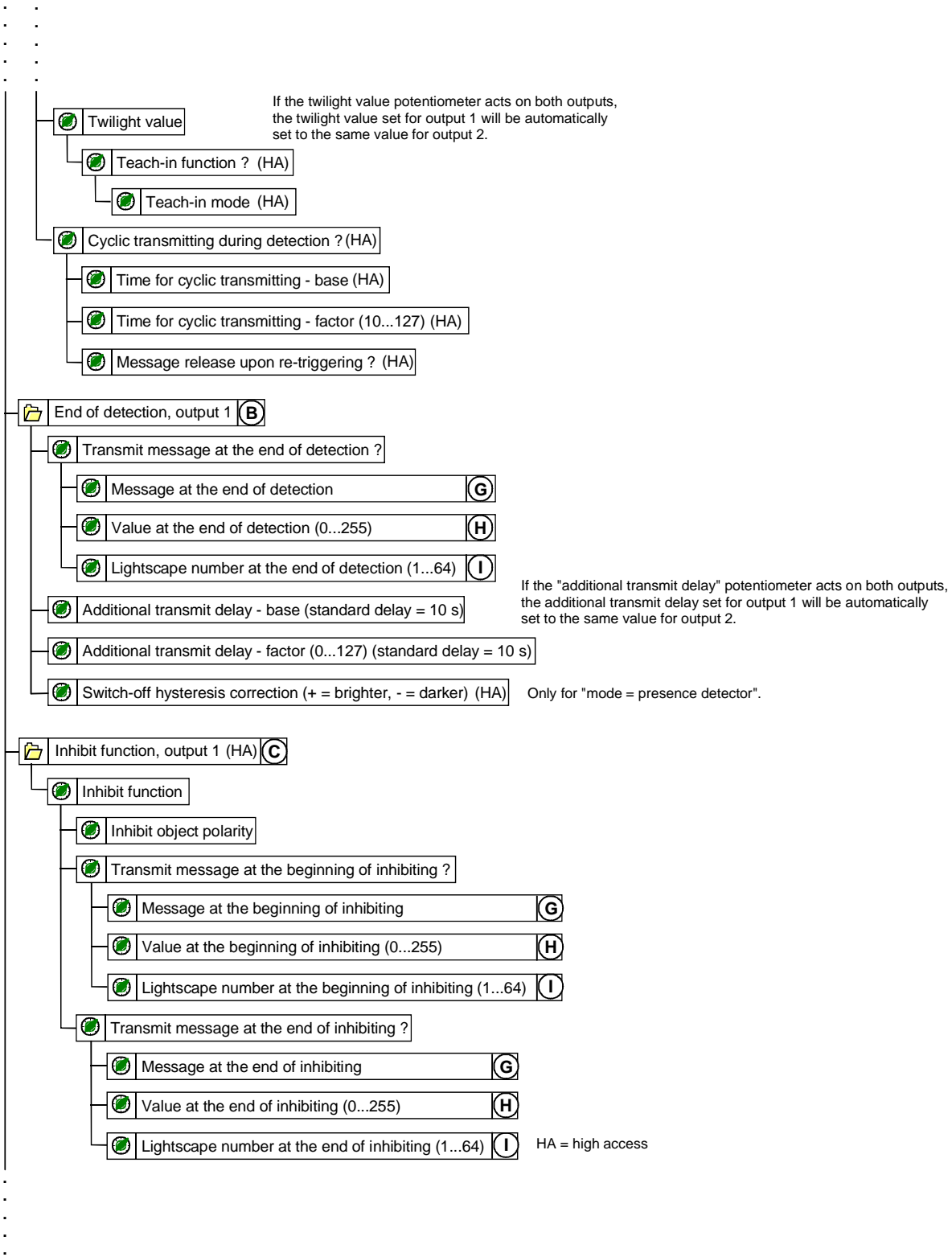
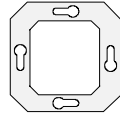

Parameter Diagram (2 / 3)

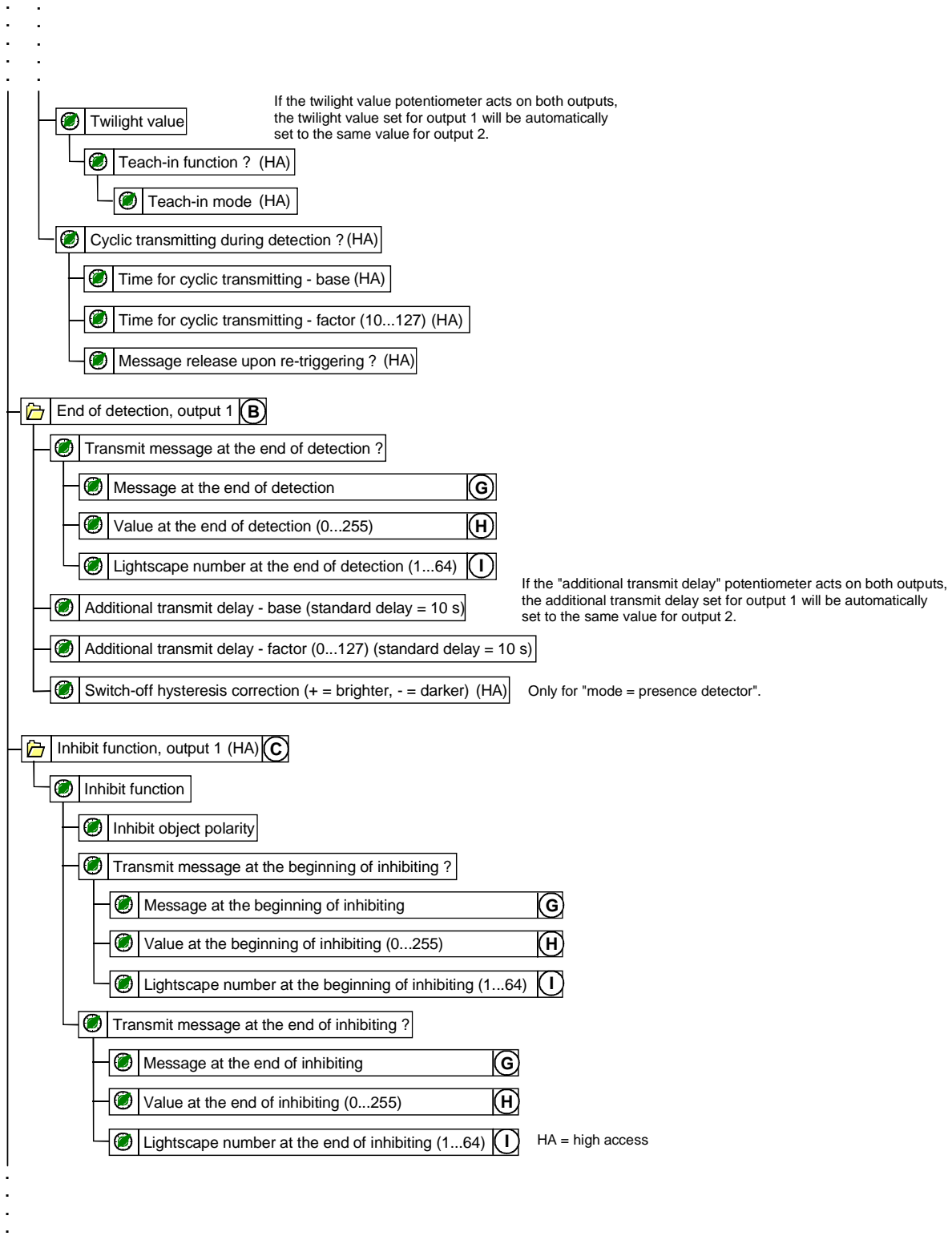
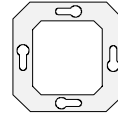

Parameter Diagram (3 / 3)

instabus EIB System

Sensor

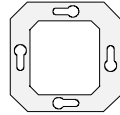

Number of addresses (max.):	30	dynamic table management:	Yes <input checked="" type="checkbox"/>	No <input type="checkbox"/>
Number of assignments (max.):	30	maximum table length:	60	
Communication objects:	8			

Function: „No function“ **)

No other output objects

Function: „Switching“ **)

Object:	Function:	Name:	Type:	Flag:
<input type="checkbox"/> 0	Switching	Output 1	1 Bit	S,K,Ü,(L)*
<input type="checkbox"/> 1	Switching	Output 2	1 Bit	S,K,Ü,(L)*

Function: „Dimming value transmitter“ **)

Object:	Function:	Name:	Type:	Flag:
<input type="checkbox"/> 0	Value	Output 1	1 Byte	S,K,Ü,(L)*
<input type="checkbox"/> 1	Value	Output 2	1 Byte	S,K,Ü,(L)*

Function: „Lightscape Extension“ **)

Object:	Function:	Name:	Type:	Flag:
<input type="checkbox"/> 0	Lightscape extension	Output 1	1 Byte	S,K,Ü,(L)*
<input type="checkbox"/> 1	Lightscape extension	Output 2	1 Byte	S,K,Ü,(L)*

Function: „Teach-In“

Object:	Function:	Name:	Type:	Flag:
<input type="checkbox"/> 2	Teach-In	Output 1	1 Bit	K,S,(L)*
<input type="checkbox"/> 3	Teach-In	Output 2	1 Bit	K,S,(L)*

Function: „Inhibiting“

Object:	Function:	Name:	Type:	Flag:
<input type="checkbox"/> 4	Inhibiting	Output 1	1 Bit	K,S,(L)*
<input type="checkbox"/> 5	Inhibiting	Output 2	1 Bit	K,S,(L)*

Function: „Trigger Object“

Object:	Function:	Name:	Type:	Flag:
<input type="checkbox"/> 6	Trigger object	Outputs 1 and 2	1 Bit	K,S,(L)*

1 Bit Data Format Alarm Function

Object:	Function:	Name:	Type:	Flag:
<input checked="" type="checkbox"/> 7	Switching	Alarm	1 Bit	K,S,Ü,(L)*

1 Byte Data Format Alarm Function

Object:	Function:	Name:	Type:	Flag:
<input checked="" type="checkbox"/> 7	Value	Alarm	1 Byte	K,S,Ü,(L)*

* For the objects marked (R) the current status can be read out (setting R flag).

** The "no function", "switching", "dimming value transmitter" and "lightscape extension" functions can be selected per output. The names of the communication objects and the object table (dynamic object structure) will change correspondingly.

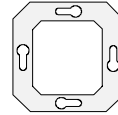

Removal detection/warning

When the application module is unplugged from the bus coupler, an ON or OFF message or a value message can be released via the alarm object. Alternatively, such message release can be suppressed by the "alarm function inhibited" ETS parameter setting.

The time between unplugging the module and releasing a message can be set by the time factor and time base ETS parameters. To exclude bouncing effects the time span set should not be below 1 second.

Data format: 1 bit

- a) Automatic resetting of the sabotage function = yes

When the application module is plugged on for the first time after having been programmed by the ETS, the object value of the alarm object will be loaded with the inverted alarm value (no alarm active), and the alarm function will be enabled. However, as long as no application module has been plugged on yet after programming, this condition can be detected when the object value is interrogated as, in this case, the alarm object value will be loaded with the alarm value (alarm active).

When the application module is unplugged, an alarm message with the parameterised alarm value (alarm active) will be transmitted after the transmit delay has elapsed. In case of bus voltage failure and bus voltage recovery, no new alarm message will be transmitted.

When the application module is plugged on again, an inverted alarm message (no alarm active) will be transmitted, and the device will be enabled (the device is operative).

- b) Automatic resetting of the sabotage function = no

When the application module is plugged on for the first time after having been programmed by the ETS, the object value of the alarm object will be loaded with the inverted alarm value (no alarm active), and the alarm function will be enabled. However, as long as no application module has been plugged on yet after programming, this condition can be detected when the object value is interrogated as, in this case, the alarm object value will be loaded with the alarm value (alarm active).

When the application module is unplugged, an alarm message with the parameterised alarm value (alarm active) will be transmitted after the transmit delay has elapsed. In case of bus voltage failure and bus voltage recovery, no new alarm message will be transmitted.

After the application module is plugged on again, the device will be disabled (the device is inoperative).

When the enable message is being received, the application module must be in plugged-on condition. If the application module is not plugged on, no enabling will take place, and the object value will remain set to the alarm value (alarm active). (The enable message with the inverted alarm value will be ignored).

instabus EIB System

Sensor

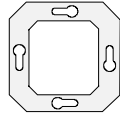

Data format: 1 byte

- a) Automatic resetting of the sabotage function = yes

When the application module is plugged on for the first time after having been programmed by the ETS, the object value of the alarm object will be loaded with the value = 0 (no alarm active), and the alarm function will be enabled. However, as long as no application module has been plugged on yet after programming, this condition can be detected when the object value is interrogated as, in this case, the alarm object value will be loaded with the alarm value (1 ... 255 = alarm active).

When the application module is unplugged, an alarm message with the parameterised alarm value (1 ... 255 = alarm active) will be transmitted after the transmit delay has elapsed. In case of bus voltage failure and bus voltage recovery, no new alarm message will be transmitted.

When the application module is plugged on again, a message with the value = 0 (no alarm active) will be transmitted, and the device will be enabled (the device is operative).

- b) Automatic resetting of the sabotage function = no

When the application module is plugged on for the first time after having been programmed by the ETS, the object value of the alarm object will be loaded with the value = 0 (no alarm active), and the alarm function will be enabled. However, as long as no application module has been plugged on yet after programming, this condition can be detected when the object value is interrogated as, in this case, the alarm object value will be loaded with the alarm value (1 ... 255 = alarm active).

When the application module is unplugged, an alarm message with the parameterised alarm value (1 ... 255 = alarm active) will be transmitted after the transmit delay has elapsed. In case of bus voltage failure and bus voltage recovery, no new alarm message will be transmitted.

After the application module is plugged on again, the device will be disabled (the device is inoperative).

It will only be enabled after receiving an alarm message with the value = 0 (enable message).

When an enable message is being received, the application module must be in plugged-on condition. If the application module is not plugged on, no enabling will take place, and the object value will remain set to the alarm value (1 ... 255 = alarm active). (The enable message with the value = 0 will be ignored!).

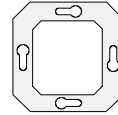

Modes of Operation

Ceiling-mounted detector mode

In the ceiling-mounted detector mode, the device detects movements and will transmit the message parameterised at the beginning of detection if the brightness value measured is below the twilight value set. If the message was transmitted at the beginning of detection, the device will work independently of the ambient brightness. If no more movements are detected, the device will transmit the parameterised message at the end of detection after the preset overall transmit delay (standard transmit delay (10 s) + additional transmit delay) has elapsed.

Independent of a movement detection, the light can also be switched on or off if the ceiling-mounted detector is disabled, upon bus voltage recovery, or by the trigger object (refer to the description of the trigger function).

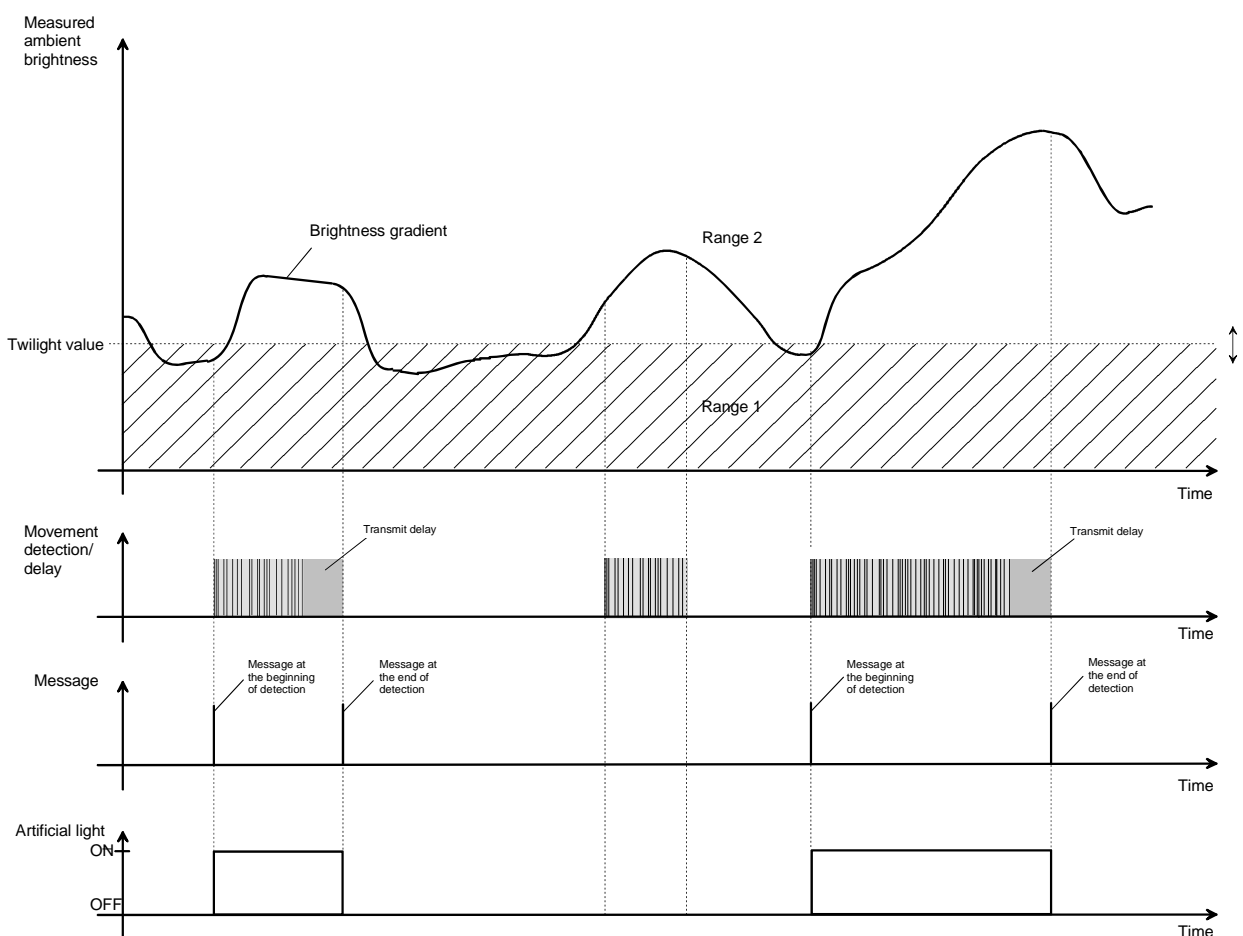

The brightness limit between range 1 and range 2 is determined by the twilight value which can be parameterised. If the ambient brightness measured falls below this value and a movement is detected, the ceiling-mounted detector will switch on the artificial light. Range 2 characterises the brightness in the room at which the room is sufficiently illuminated and, therefore, no artificial light needs to be switched on. If the ambient brightness is within this range and the device detects no movement, no artificial light will be switched on.

The 'sensitivity' parameter determines the intensity of the movement impulses to detect a movement. Thus, to avoid erroneous switching, for example, it is possible to reduce the sensitivity of the PIR sensors.

If the twilight value has been parameterised to "brightness-independent", the artificial light will always be switched on without any monitoring of the ambient brightness once a movement is detected.

instabus EIB System

Sensor

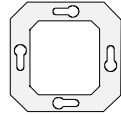

Presence detector mode

In the presence detector mode, the device detects the presence of a person and will transmit the message parameterised at the beginning of detection if the brightness value measured is below the twilight value set. If no more presence is detected now and the preset overall transmit delay (standard transmit delay (10 s) + additional transmit delay) has elapsed, or if the preset twilight value has been exceeded, for example, by double the value for at least 10 minutes (depending on the software), the presence detector will transmit the parameterised message at the end of detection.

The differences in the functionality compared with the ceiling-mounted detector mode are in the processing of:

- a) *the movement signal:*
Contrary to the ceiling-mounted detector function, only a succession of movement impulses leads to presence detection.
- b) *the brightness signal:*
The adjustable brightness range to be evaluated as twilight value is wider than for the ceiling-mounted detector mode.
Only after double the value of the preset twilight value (switch-off brightness) is exceeded, the configured message will be transmitted at the end of the detection event after at least 10 minutes, even though the presence of a person is detected.
This switch-off brightness can be altered in the parameters through a correction value.
- c) *the combination in the evaluation of the movement and brightness impulses:*
The light will be switched on when it is needed, i. e. after the presence of a person has been detected and a brightness value below the preset twilight value has been measured.
The light will be switched off when it is no longer needed, i. e. nobody is present any longer, or the brightness is sufficient without additional illumination.

Independent of a movement detection, the light can also be switched on or off if the presence detector is disabled, upon bus voltage recovery, or by the trigger object (refer to the description of the triggering function).

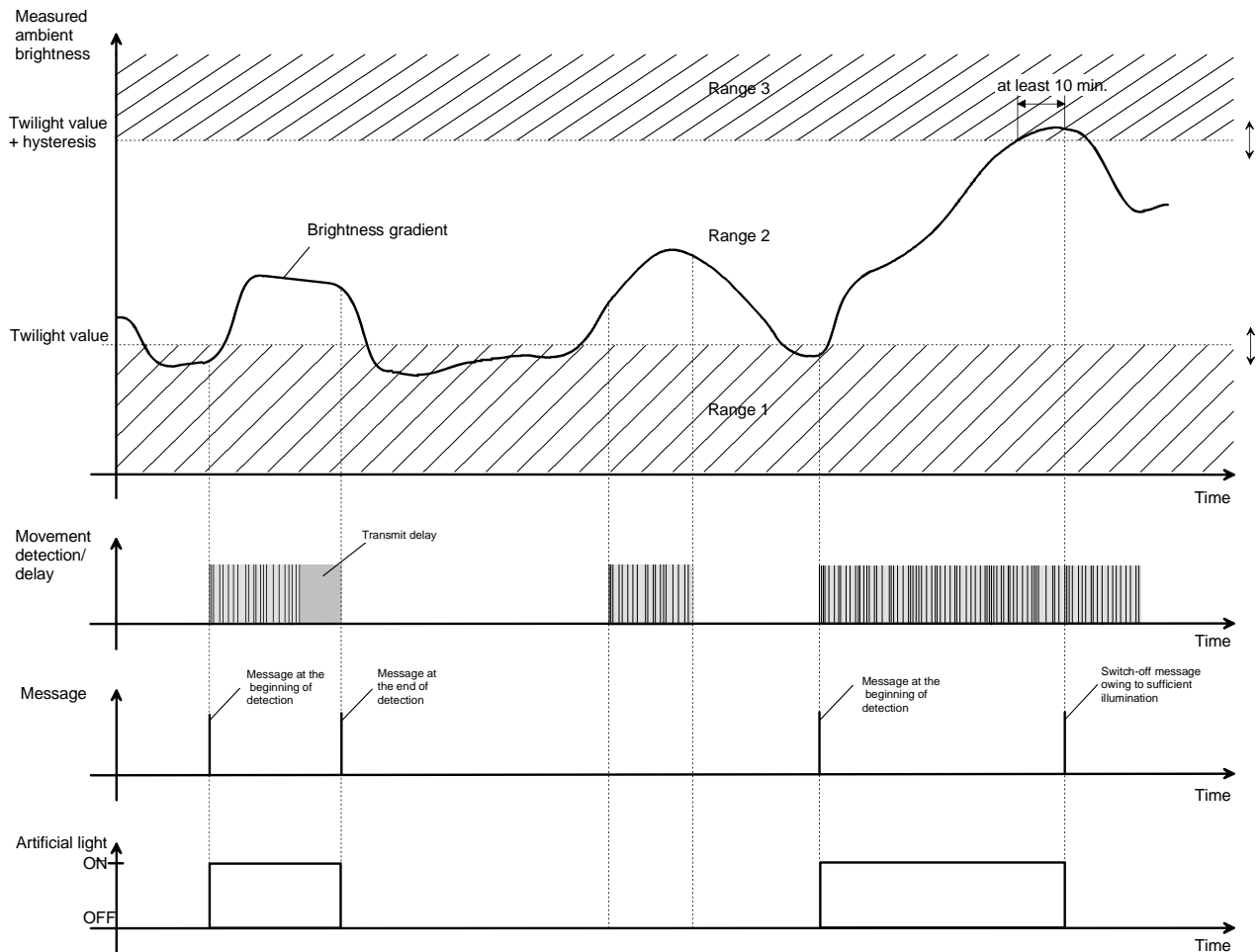
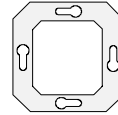

The brightness limit between range 1 and range 2 is determined by the twilight value which can be parameterised. If the ambient brightness measured falls below this value and the presence of a person is detected, the presence detector will switch on the artificial light. Range 2 characterises the brightness in the room the presence detector is to adjust. If the ambient brightness is within this range and the device detects a new movement, no artificial light will be switched on. The border between ranges 2 and 3 is determined by the twilight value plus the hysteresis (refer to the "Hysteresis and correction value" description further below). If the ambient brightness measured exceeds this brightness threshold permanently, the artificial light will be switched off after 10 minutes at the earliest. The time until the switch-off moment can be longer than 10 minutes if the ambient brightness does not permanently exceed the threshold between ranges 2 and 3, i. e. if the brightness sometimes decreases or sometimes increases, respectively. This switch-off time serves to 'debounce' short-time light reflections and prevents erroneous switching of the light.

If the twilight value has been parameterised to "brightness-independent", the artificial light will always be switched on without any monitoring of the ambient brightness once the presence of a person is detected.

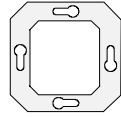

Hysteresis and correction value

The border between ranges 2 and 3 (switch-off threshold) can be parameterised and adapted to the ambient conditions. If the artificial light is found to switch off too early (too late) the switch-off threshold can be shifted up (down). Such shifting of the switch-off threshold is described by the correction value ("switch-off hysteresis correction").

In the standard case, the hysteresis is double (100 %) the parameterised twilight value. If the threshold is to be shifted down, a negative value must be selected. If the threshold is to be shifted up, parameterise a positive value. The hysteresis must be specified as a percentage of the parameterised twilight value to have an additional reference. The following illustration shows various parameterisation examples.

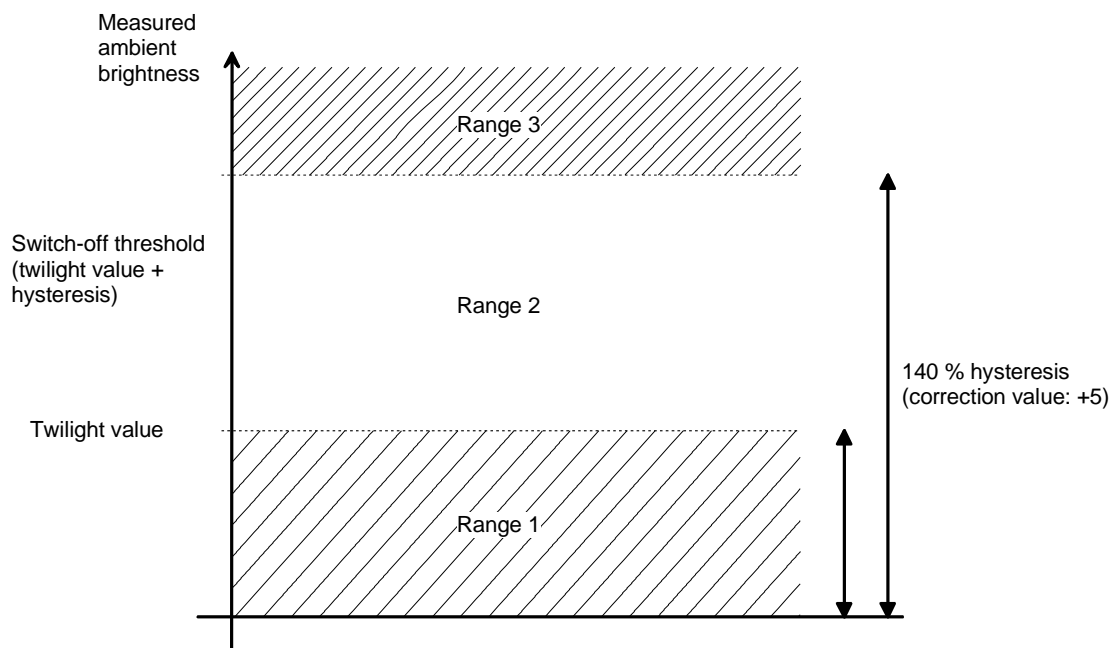
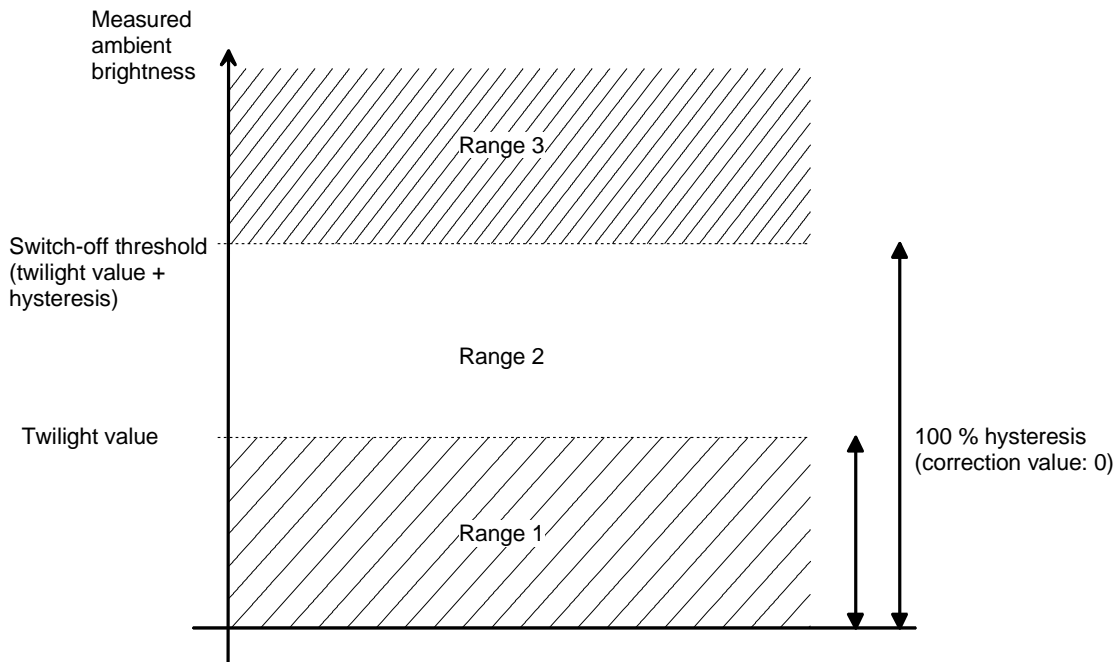

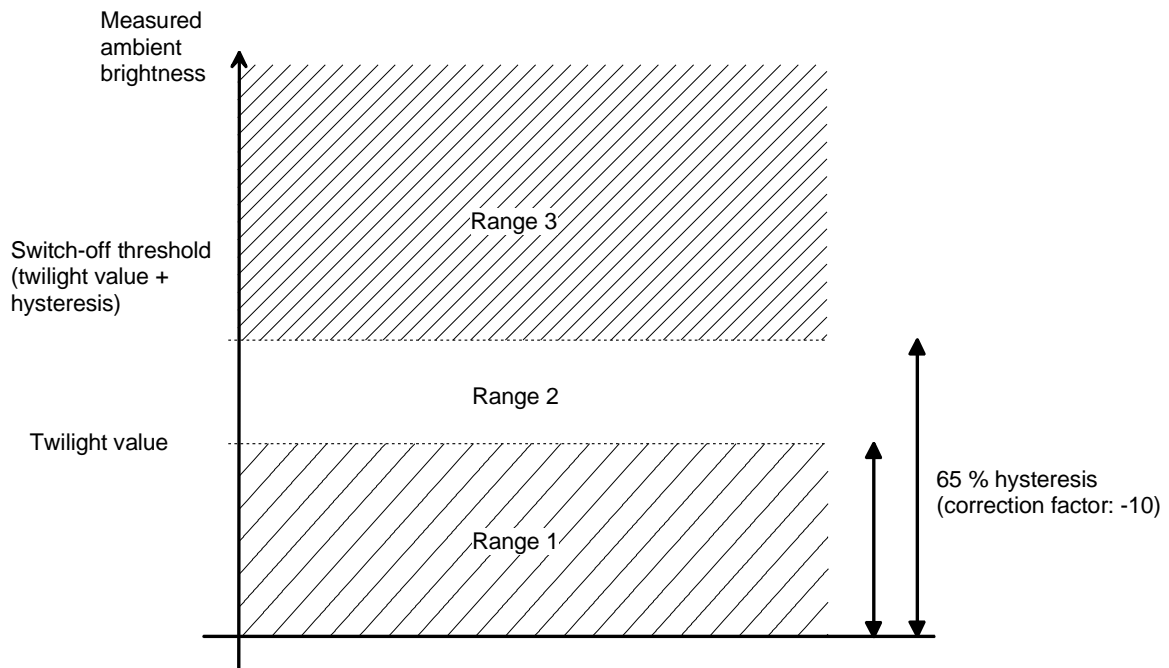

Teach-in function

The teach-in function allows a directly local, object-controlled adaptation of the twilight value (switch-on threshold) to the ambient conditions. For this purpose, a separate teach-in object is available for each output.

In such case, the device accepts as the new twilight value the currently measured ambient brightness 3 s after an update to the teach-in object. The effect of the delay of these 3 s is that some actuators can be activated in parallel by the message for the triggering of the teach-in function to set a different illumination situation before the new twilight value is saved.

So as not to influence the brightness value by any actions of the presence detector (e. g. on, off, value messages, cyclic transmitting, inhibit messages, etc.) within the delay of the 3 s, presence and movement evaluation or brightness control, respectively, will be disabled until the new twilight value is accepted.

The polarity of a teach-in message can be parameterised. Depending on the parameterisation, you can switch back to the originally parameterised twilight value by the reception of the opposite object value (teach-in function inactive). In this case, you will lose the twilight value taught in before. However, if the teach-in mode has been parameterised to "1"- and "0"-active, you cannot switch back to the twilight value originally programmed by the ETS while the device is in operation. In such case, you can only restore the original value by re-programming.

Several successively received updates to the teach-in object (teach-in function active) each time cause a new twilight value saving process.

The twilight value taught in by the teach-in function will be kept permanently saved in the EEPROM of the bus coupler until a new teach-in message is received so that a bus voltage failure will not lead to the loss of the value taught in.

If a new twilight value has been set for a channel by the teach-in function, this value cannot be altered by the twilight value potentiometer. The inhibit function has no influence on the teach-in function.

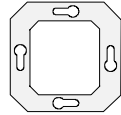

Trigger function

Via the trigger object, the device can be caused to transmit the messages of the two output objects, even though no movement has been detected. The reception of a message having the value = 1 via the trigger object is processed in the same way as a detected movement. The reception of a message having the value = 0 has no effect at all (no response).

a) Mode of action "brightness-independent":

The reception of a trigger message (value = 1) is evaluated in the same way as a detected movement. Depending on the parameterisation, the "message at the beginning of detection" is transmitted.

If the device is not actively detecting a movement when receiving the trigger message (value = 1), a message (message at the beginning of detection) will, if parameterised, be transmitted via the output channels.

If the device is already actively detecting a movement when receiving the trigger message, messages will only be transmitted via the output channels during the additional transmit delay, provided "message release upon re-triggering = YES" has been parameterised. The transmit delay will be re-triggered.

b) Mode of action "brightness-dependent":

This setting will only be correctly processed if the twilight value has also been parameterised brightness-dependent. Otherwise, processing will be the same as for brightness-independent parameterisation.

If the device is not actively detecting a movement when receiving the trigger message (value = 1), a message (message at the beginning of detection) will, if parameterised, be transmitted via the output channels, depending on the current brightness (parameter settings of the channels).

If the device is already actively detecting a movement when receiving the trigger message, messages will only be transmitted via the output channels during the additional transmit delay, provided "message release upon re-triggering = YES" has been parameterised. The transmit delay will be re-triggered.

If the current brightness is already above the switch-off threshold (presence mode), and if the switch-off delay (10 min.) is active, this time will not be affected when the trigger message is being received, i. e. the light will be switched off, for example, after this time has elapsed.

After bus voltage recovery, no triggering will be possible during the PIR immunity time of about 40 s and during an elapsing inhibit time.

An inhibited output channel cannot be activated by the trigger object.

The trigger function serves for enabling the user to switch on the light, although he/she is not within the detection range of the device. It does not serve as extension input to combine, for example, several presence or other detector devices.

Inhibit function

By separate inhibit objects for each output channel, a message transmitted to the respective inhibit object can be used to prevent one or both channels, respectively, from responding to a movement detected. This also applies to the trigger object. An inhibited output channel can be activated neither by a movement detected nor by the trigger object.

At the beginning and at the end of the inhibiting, an own message can be transmitted separately for each output containing the function parameterised for this output.

After the re-enabling of the corresponding output(s), normal operation will be resumed after the "message at the end of inhibiting".

During the inhibiting of an output in the presence detector mode, an active switch-off time (10 min.) will no longer be processed at an ambient brightness above the switch-off threshold. At the beginning of inhibiting, the switch-off time is reset. After the cancellation of the inhibit state, the switch-off time will be started again if the ambient brightness is still above the switch-off threshold. Therefore, switching off the light due to an excessively high brightness will take place 10 minutes after the cancellation of the inhibit state at the earliest.

The teach-in function is also operative during the inhibiting of a channel.

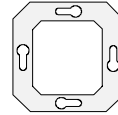

Parameters		
Description:	Values:	Comment:
General		
Mode	Presence detector Ceiling-mounted detector	This parameter specifies the mode.
Output 1 function	No function Switching Dimming value transmitter Lightscape extension	This parameter specifies the function of output 1.
Output 2 function (FA)	No function Switching Dimming value transmitter Lightscape extension	This parameter specifies the function of output 2.
"Twilight value" potentiometer acts on	No output Output 1 Output 2 * Outputs 1 and 2 *	This parameter specifies the assignment of the "twilight value" potentiometer to the outputs. If this potentiometer acts on both outputs, setting the twilight value for output 1 will be sufficient. *: Only for "output 2 function = switching", "dimming value transmitter" or "lightscape extension".
"Additional transmit delay" potentiometer acts on	No output Output 1 Output 2 * Outputs 1 and 2 *	This parameter specifies the assignment of the "additional transmit delay" potentiometer to the outputs. If this potentiometer acts on both outputs, setting the additional transmit delay for output 1 will be sufficient. The overall delay for the release of the message at the end of a detection event results from addition of the standard time delay (10 s) with the additional transmit delay. *: Only for "output 2 function = switching", "dimming value transmitter" or "lightscape extension".

instabus EIB System

Sensor

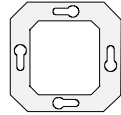

 General		
Activate trigger object?	Yes No	This parameter can enable the trigger function.
Trigger object mode of action	Brightness-independent Brightness-dependent	It can be specified whether the response of the trigger object is to be brightness-independent or brightness-dependent.
Inhibit time after message release - base	8 ms 130 ms 2.1 s 33 s	After the overall delay has elapsed, an inhibit time can be activated which prevents switching back on the consumers by cooling-down processes. The presence detector will only detect further movements after this inhibit time. Inhibit time = base · factor
Inhibit time after message release - factor	0...255 (Default 23)	Definition of the inhibit time factor. Inhibit time = base · factor Presetting: 130 ms · 23 = 2.99 s
Sensitivity (FA)	High Medium Low	The sensitivity of PIR evaluation in the ceiling-mounted detector mode can be adapted. The device also responds to shorter and weaker movement signals. The device responds less sensitively to movement signals. The device only responds to longer and stronger movement signals. Only for "mode = ceiling-mounted detector".

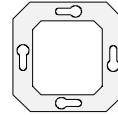

 Evaluation of a detection event, output 1		
Transmit message at the beginning of detection?	Yes No	This parameter specifies whether a message is to be transmitted at the beginning of a detection event.
Message at the beginning of detection?	ON message OFF message	At the beginning of a detection event, a switching message is transmitted. Only for the output 1 = "switching" function.
Value at the beginning of detection (0...255)	0 to 255 (Default 255)	At the beginning of a detection event, a value message is transmitted. Only for the output 1 = "dimming value transmitter" function.
Lightscape number at the beginning of detection (1...64)	1 to 64 (Default 1)	At the beginning of a detection event, a lightscape recall message is transmitted. Only for the output 1 = "lightscape extension" function.
Twilight value	Brightness-independent Mode = "presence detector" Range 100-300 lux Range 300-600 lux Range 600-1000 lux Mode = "ceiling-mounted detector" Range 10-30 lux Range 30-60 lux Range 60-100 lux	Message releasing is brightness-independent. When the light is off, messages will only be released if the brightness is below the preset value. This value results from the range set through the ETS and the associated twilight value potentiometer as follows: Potentiometer middle position = mean value of the range set through the ETS. Potentiometer zero position = lower limit of the range set through the ETS. Potentiometer maximum position = upper limit of the range set through the ETS. If this potentiometer acts on both outputs, setting the twilight value for output 1 will be sufficient.
Teach-in function? (FA)	Yes No	This parameter enables the teach-in function. If twilight value = "brightness-dependent", no teach-in function will be possible.
Teach-in mode (FA)	0 = active, 1 = inactive 1 = active, 0 = inactive 0 = active, 1 = active	This parameter specifies the polarity of the teach-in object. At an object value of "0", the teach-in function is active. At an object value of "1", the teach-in function is active. At an object value of "0" or "1", the teach-in function is active, i. e. a new brightness value is accepted upon each object update.

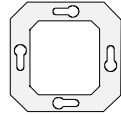

Evaluation of a detection event, output 1																	
Cyclic transmitting during detection? (FA)	Yes No	Cyclic transmitting during a movement detected can be activated or deactivated, respectively. A movement is to be understood the period from the beginning of the first detection impulse including the standard delay (10 s) beginning at the last rising edge of the thermal movement signal plus the additional transmit delay. 															
Cyclic transmitting - base (FA)	<table border="0"> <tr> <td>1 s</td> <td>34 s</td> <td>9 min</td> </tr> <tr> <td>2.1 s</td> <td>1.1 min</td> <td>18 min</td> </tr> <tr> <td>4.2 s</td> <td>2.2 min</td> <td>35 min</td> </tr> <tr> <td>8.4 s</td> <td>4.5 min</td> <td></td> </tr> <tr> <td>17 s</td> <td></td> <td></td> </tr> </table>	1 s	34 s	9 min	2.1 s	1.1 min	18 min	4.2 s	2.2 min	35 min	8.4 s	4.5 min		17 s			Time base for cyclic transmitting. Cyclic transmitting = base · factor
1 s	34 s	9 min															
2.1 s	1.1 min	18 min															
4.2 s	2.2 min	35 min															
8.4 s	4.5 min																
17 s																	
Cyclic transmitting - factor (10...127) (FA)	10 to 127 (Default 10)	Time factor for cyclic transmitting. Cyclic transmitting = base · factor Presetting: 1 s · 10 = 1 s															
Message release upon re-triggering? (FA)	NO YES	Re-triggering during the additional transmit delay can be initiated with or without a message. Only for "cyclic transmitting = NO".															

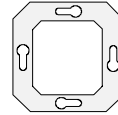

📁 End of a detection event, output 1																																															
Transmit message at the end of detection?	Yes No	This parameter specifies whether a message is to be transmitted at the end of a detection event.																																													
Message at the end of detection	ON message OFF message	At the end of a detection event, a switching message is transmitted. Only for the output 1 = "switching" function.																																													
Value at the end of detection (0...255)	0 to 255 (Default 0)	At the end of a detection event, a value message is transmitted. Only for the output 1 = "dimming value transmitter" function.																																													
Lightscape number at the end of detection (1...64)	1 to 64 (Default 1)	At the end of a detection event, a lightscape call message is transmitted. Only for the output 1 = "lightscape extension" function.																																													
Additional transmit delay - base (standard delay = 10 s)	<table style="border: none;"> <tr> <td>1 s</td> <td>17 s</td> <td>4.5 min</td> </tr> <tr> <td>2.1 s</td> <td>34 s</td> <td>9 min</td> </tr> <tr> <td>4.2 s</td> <td>1.1 min</td> <td>18 min</td> </tr> <tr> <td>8.4 s</td> <td>2.2 min</td> <td>35 min</td> </tr> </table>	1 s	17 s	4.5 min	2.1 s	34 s	9 min	4.2 s	1.1 min	18 min	8.4 s	2.2 min	35 min	<p>The overall delay results from addition of the standard time delay (10 s) with the additional transmit delay.</p> <p style="text-align: center;">Additional transmit delay = base · factor</p>																																	
1 s	17 s	4.5 min																																													
2.1 s	34 s	9 min																																													
4.2 s	1.1 min	18 min																																													
8.4 s	2.2 min	35 min																																													
Additional transmit delay - factor (0...127)	0 to 127 (Default 35)	<p>Definition of the additional transmit delay time factor.</p> <p style="text-align: center;">Additional transmit delay = base · factor</p> <p>Presetting: 1 s · 35 = 35 s</p>																																													
Switch-off hysteresis correction (+ = brighter, - = darker) (FA)	<table style="border: none;"> <tr> <td>-15</td> <td>0</td> <td>+1</td> </tr> <tr> <td>-14</td> <td></td> <td>+2</td> </tr> <tr> <td>-13</td> <td></td> <td>+3</td> </tr> <tr> <td>-12</td> <td></td> <td>+4</td> </tr> <tr> <td>-11</td> <td></td> <td>+5</td> </tr> <tr> <td>-10</td> <td></td> <td>+6</td> </tr> <tr> <td>-9</td> <td></td> <td>+7</td> </tr> <tr> <td>-8</td> <td></td> <td>+8</td> </tr> <tr> <td>-7</td> <td></td> <td>+9</td> </tr> <tr> <td>-6</td> <td></td> <td>+10</td> </tr> <tr> <td>-5</td> <td></td> <td>+11</td> </tr> <tr> <td>-4</td> <td></td> <td>+12</td> </tr> <tr> <td>-3</td> <td></td> <td>+13</td> </tr> <tr> <td>-2</td> <td></td> <td>+14</td> </tr> <tr> <td>-1</td> <td></td> <td>+15</td> </tr> </table>	-15	0	+1	-14		+2	-13		+3	-12		+4	-11		+5	-10		+6	-9		+7	-8		+8	-7		+9	-6		+10	-5		+11	-4		+12	-3		+13	-2		+14	-1		+15	<p>It is possible to adapt the switch-off brightness by the correction value.</p> <p>After double the value (100 %) of the preset twilight value (switch-off brightness) is exceeded, the parameterised message will be transmitted at the end of the detection event after about 10 minutes, even though presence is detected.</p>
-15	0	+1																																													
-14		+2																																													
-13		+3																																													
-12		+4																																													
-11		+5																																													
-10		+6																																													
-9		+7																																													
-8		+8																																													
-7		+9																																													
-6		+10																																													
-5		+11																																													
-4		+12																																													
-3		+13																																													
-2		+14																																													
-1		+15																																													

instabus EIB System

Sensor

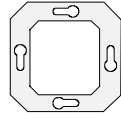

Inhibit function		
Inhibit function	Enabled Disabled	This parameter can enable the inhibit function.
Inhibit object polarity	0 = enabled, 1 = inhibited 1 = enabled, 0 = inhibited	The inhibit function is active at an object value = 1. The inhibit function is active at an object value = 0.
Transmit message at the beginning of inhibiting?	Yes No	This parameter specifies whether a message is to be transmitted at the beginning of inhibiting.
Message at the beginning of inhibiting	ON message OFF message	At the beginning of inhibiting, a switching message is transmitted. Only for the output 1 = "switching" function.
Value at the beginning of inhibiting (0...255)	0 to 255 (Default 0)	At the beginning of inhibiting, a value message is transmitted. Only for the output 1 = "dimming value transmitter" function.
Lightscape number at the beginning of inhibiting (1...64)	1 to 64 (Default 1)	At the beginning of inhibiting, a lightscape call message is transmitted. Only for the output 1 = "lightscape extension" function.
Transmit message at the end of inhibiting?	Yes No	This parameter specifies whether a message is to be transmitted at the end of inhibiting.
Message at the end of inhibiting	ON message OFF message	At the end of inhibiting, a switching message is transmitted. Only for the output 1 = "switching" function.
Value at the end of inhibiting (0...255)	0 to 255 (Default 0)	At the end of inhibiting, a value message is transmitted. Only for the output 1 = "dimming value transmitter" function.
Lightscape number at the end of inhibiting (1...64)	1 to 64 (Default 1)	At the end of inhibiting, a lightscape call message is transmitted. Only for the output 1 = "lightscape extension" function.
For the evaluation of a detection event, output 2		refer to output 1.
For the end of a detection event, output 2		refer to output 1.
For the inhibit function, output 2		refer to output 1.



 Bus voltage recovery		
Output 1: Transmit message upon bus voltage recovery?	Yes No	This parameter specifies whether a message is to be transmitted upon bus voltage recovery.
Message upon bus voltage recovery	ON message OFF message	Upon bus voltage recovery, a switching message is transmitted. Only for the output 1 = "switching" function.
Value upon bus voltage recovery (0...255)	0 to 255 (Default 0)	Upon bus voltage recovery, a value message is transmitted. Only for the output 1 = "dimming value transmitter" function.
Lightscape number upon bus voltage recovery (1...64)	1 to 64 (Default 1)	Upon bus voltage recovery, a lightscape call message is transmitted. Only for the output 1 = "lightscape extension" function.
Output 2: Transmit message upon bus voltage recovery?	Yes No	This parameter specifies whether a message is to be transmitted upon bus voltage recovery.
Message upon bus voltage recovery	ON message OFF message	Upon bus voltage recovery, a switching message is transmitted. Only for the output 2 = "switching" function.
Value upon bus voltage recovery (0...255)	0 to 255 (Default 0)	Upon bus voltage recovery, a value message is transmitted. Only for the output 2 = "dimming value transmitter" function.
Lightscape number upon bus voltage recovery (1...64)	1 to 64 (Default 1)	Upon bus voltage recovery, a lightscape call message is transmitted. Only for the output 2 = "lightscape extension" function.

instabus EIB System

Sensor

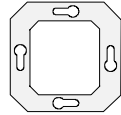

 Alarm function		
Alarm function	Enabled Disabled	This parameter can enable the alarm function.
Alarm object data format	1 bit 1 byte	This parameter specifies the data format of the alarm object.
Command after application module has been unplugged	ON message OFF message	Upon an alarm, a switching message is transmitted. Only for "data format = 1 bit".
Value after application module has been unplugged (1...255)	1 to 255 (Default 1)	Upon an alarm, a value message is transmitted. Only for "data format = 1 byte". The value for resetting the alarm (enable message) is "0". Only required if "automatic resetting of the sabotage function = NO".
Transmit delay - base	8 ms 130 ms 2.1 s 33 s	When the application module is being unplugged, the alarm message will be transmitted after the transmit delay has elapsed. Transmit delay = base · factor
Transmit delay - factor (1...255)	1 to 255 (Default 3)	Definition of the transmit delay time factor. Transmit delay = base · factor Presetting: 130 ms · 3 = 390 ms
Automatic resetting of the sabotage function?	Yes No	This parameter specifies whether an alarm is to be reset upon the re-plugging of the application module after such alarm was released. An inverted alarm message (1 bit) or a message with the value = 0 (1 byte) is automatically transmitted and the device enabled (the device is operative). To enable the device, an enable message (inverted alarm message with 1 bit or a message having the value = 0 with 1 byte) must be transmitted to the alarm object with the application module plugged on.

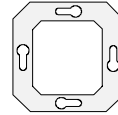

Remarks on the software

- Detection of a movement

A movement is to be understood the period from the beginning of the first detection impulse including the standard delay (10 s) beginning at the last rising edge of the thermal movement signal plus the additional transmit delay.

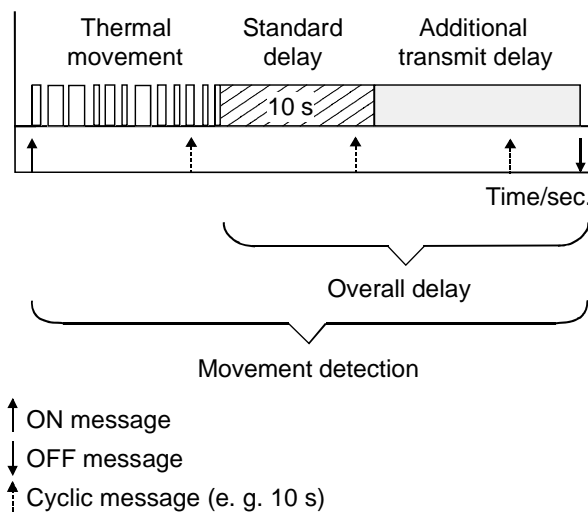

Messages can be transmitted at the beginning and at the end of a movement. During the detection of a movement, the presence detector is in the brightness-independent mode, i. e. it re-triggers the overall delay for each new movement detection, no matter what the ambient brightness is. If no OFF message or "0"-value message is transmitted at the end of a detection event, the presence detector is still in the brightness-independent mode. Only when an OFF message or "0"-value message is received externally via the output objects, the presence detector will start the inhibit time. Afterwards, movements can be detected again.

It should be noted that, after a lightscape call at the end of a detection event was transmitted, the presence detector will always work in the brightness-dependent mode, unless the twilight value has been set to brightness-independent. Therefore, special care should be taken because this may lead to unintentional movement detection if the ambient brightness preset by the lightscape called is not above the twilight value.

Also upon bus voltage recovery and during or after inhibiting, the presence detector may be in the brightness-independent mode, depending on the messages transmitted.

Cooperation of outputs 1 and 2:

Owing to differently parameterised delay times, it may happen that outputs 1 and 2 transmit messages at different moments. What should be noted in this connection is that the outputs may interlock each other.

The following example is to describe this correlation in closer detail:

If the inhibit time is started by output 1 (end of a detection event), and if output 2 is actively detecting a movement at this time, output 2 will also be inhibited, i. e. it will not detect any more movements during the inhibit period. This avoids re-triggering output 2 by the lamp switched off by output 1. After the inhibit time of output 1 has elapsed, output 2 is re-enabled to detect movements.

If the additional transmit delay of output 2 elapses within the inhibit time (end of a detection event by output 2), the inhibit time will be restarted, and both outputs will continue to be inhibited.

instabus EIB System

Sensor

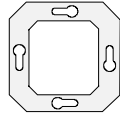

- **Twilight value**

When the light is off and the twilight value has been preset not to be brightness-independent, messages will only be released if the brightness is below the preset value. This value results from the range set via the ETS and from the associated twilight value potentiometer as follows:

- Potentiometer middle position = mean value of the range set through the ETS
- Potentiometer minimum position = lower limit of the range set through the ETS
- Potentiometer maximum position = upper limit of the range set through the ETS

If this potentiometer acts on both outputs, setting the twilight value for output 1 will be sufficient.

The twilight value potentiometer can be disabled through parameter "the 'twilight value' potentiometer acts on". If the potentiometer is disabled, the average of the brightness value set per output by means of the "twilight value" parameter will apply.

- **"Additional transmit delay" potentiometer**

With the aid of the "additional transmit delay" potentiometer, the length of the additional transmit delay can be infinitely varied by $\pm 50\%$ of the value parameterised by the ETS.

The length set by the potentiometer results from the following:

- Potentiometer middle position = the value set by the ETS
- Potentiometer minimum position = -50% of the value set by the ETS
- Potentiometer maximum position = $+50\%$ of the value set by the ETS

If the twilight value potentiometer acts on both outputs, setting the additional transmit delay for output 1 will be sufficient.

The twilight value potentiometer can be disabled through parameter "the 'additional transmit delay' potentiometer acts on". If the potentiometer is disabled, the value set per output by means of the "additional transmit delay" parameter will apply.